



US00D361323S

# United States Patent [19]

[11] Patent Number: Des. 361,323

Yamazaki et al.

[45] Date of Patent: \*\* Aug. 15, 1995

## [54] PERSONAL COMPUTER HOUSING

## DESCRIPTION

[75] Inventors: **Kazuhiko Yamazaki**, Hiratuka;  
**Hisashi Shima**, Fujisawa, both of  
Japan

[73] Assignee: **International Business Machines  
Corporation**, Armonk, N.Y.

[\*\*] Term: **14 Years**

[21] Appl. No.: **17,292**

[22] Filed: **Jan. 7, 1994**

### [30] Foreign Application Priority Data

Jul. 23, 1993 [JP] Japan ..... 5-22749

[52] U.S. Cl. .... **D14/106**

[58] Field of Search ..... D14/100, 101, 106, 113,  
D14/115, 124-127; D18/1, 7, 11, 12; 235/145  
A, 145 R; 345/104, 156, 168, 173, 901-905, 87;  
341/22, 23; 361/679-686, 680, 681; 364/708.1,  
709.04, 709.12; 400/486, 489

### [56] References Cited

#### U.S. PATENT DOCUMENTS

D. 337,101	7/1993	Shie et al. ....	D14/106
D. 346,592	5/1994	High et al. ....	D14/106
5,034,858	7/1991	Kawamoto et al. ....	361/680
5,103,376	4/1992	Blonder .....	361/681
5,255,214	10/1993	Ma .....	361/680

*Primary Examiner*—Freda S. Nunn

*Attorney, Agent, or Firm*—Martin J. McKinley; Andrew  
J. Dillon

### [57] CLAIM

The ornamental design for a personal computer housing,  
as shown and described.

FIG. 1 is a front elevational view of a personal computer housing with the cover opened;  
FIG. 2 is a rear elevational view thereof with the cover opened;  
FIG. 3 is a top plan view thereof with the cover opened;  
FIG. 4 is a bottom plan view thereof with the cover opened;  
FIG. 5 is a left side elevational view thereof with the cover;  
FIG. 6 is a right side elevational view thereof with the cover opened;  
FIG. 7 is a front elevational view thereof with the cover reversed and closed;  
FIG. 8 is a rear elevational view thereof with the cover reversed and closed;  
FIG. 9 is a top plan view thereof with the cover reversed and closed;  
FIG. 10 is a bottom plan view thereof with the cover reversed and closed;  
FIG. 11 is a left side elevational view thereof with the cover reversed and closed;  
FIG. 12 is a right side elevational view thereof with the cover reversed and closed;  
FIG. 13 is a front elevational view thereof with the cover closed;  
FIG. 14 is a rear elevational view thereof with the cover closed;  
FIG. 15 is a top plan view thereof with the cover closed;  
FIG. 16 is a bottom plan view thereof with the cover closed;  
FIG. 17 is a left side elevational view thereof with the cover closed;  
FIG. 18 is a right side elevational view thereof with the cover closed; and,  
FIG. 19 is a top front and right side perspective view thereof with the cover closed.

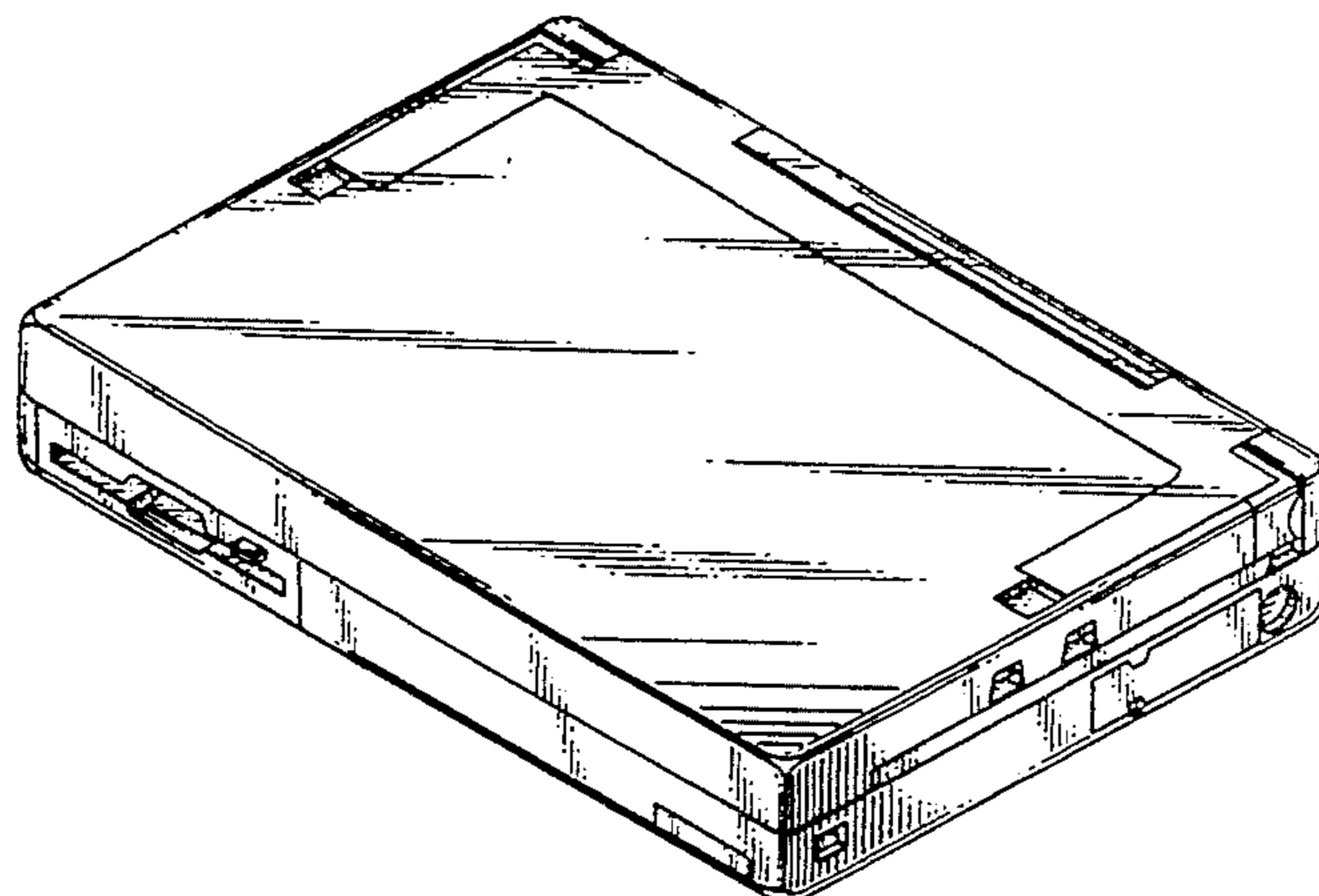
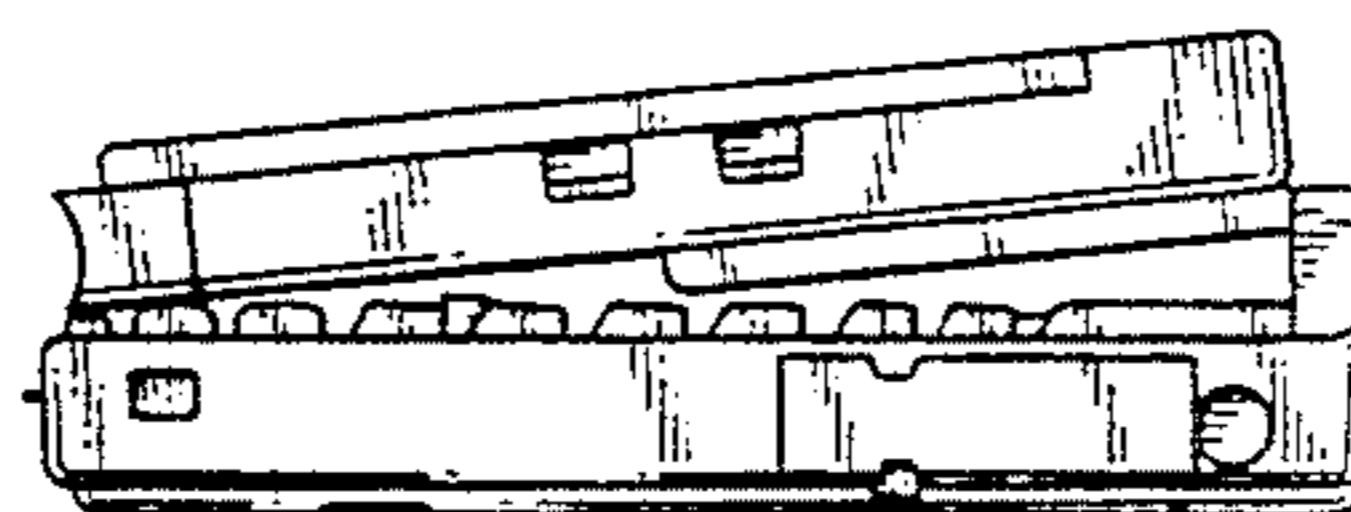

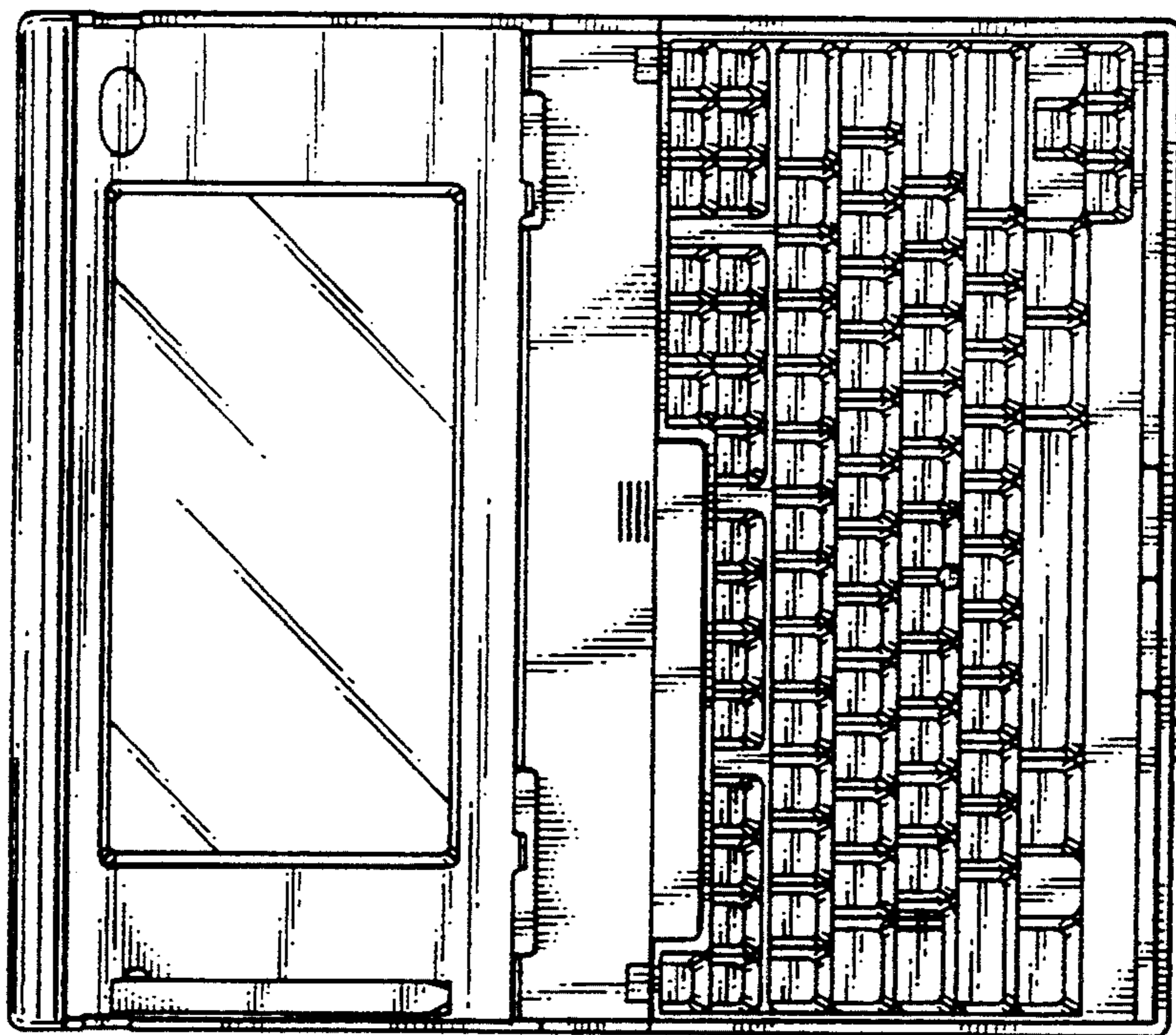

*Fig. 3*

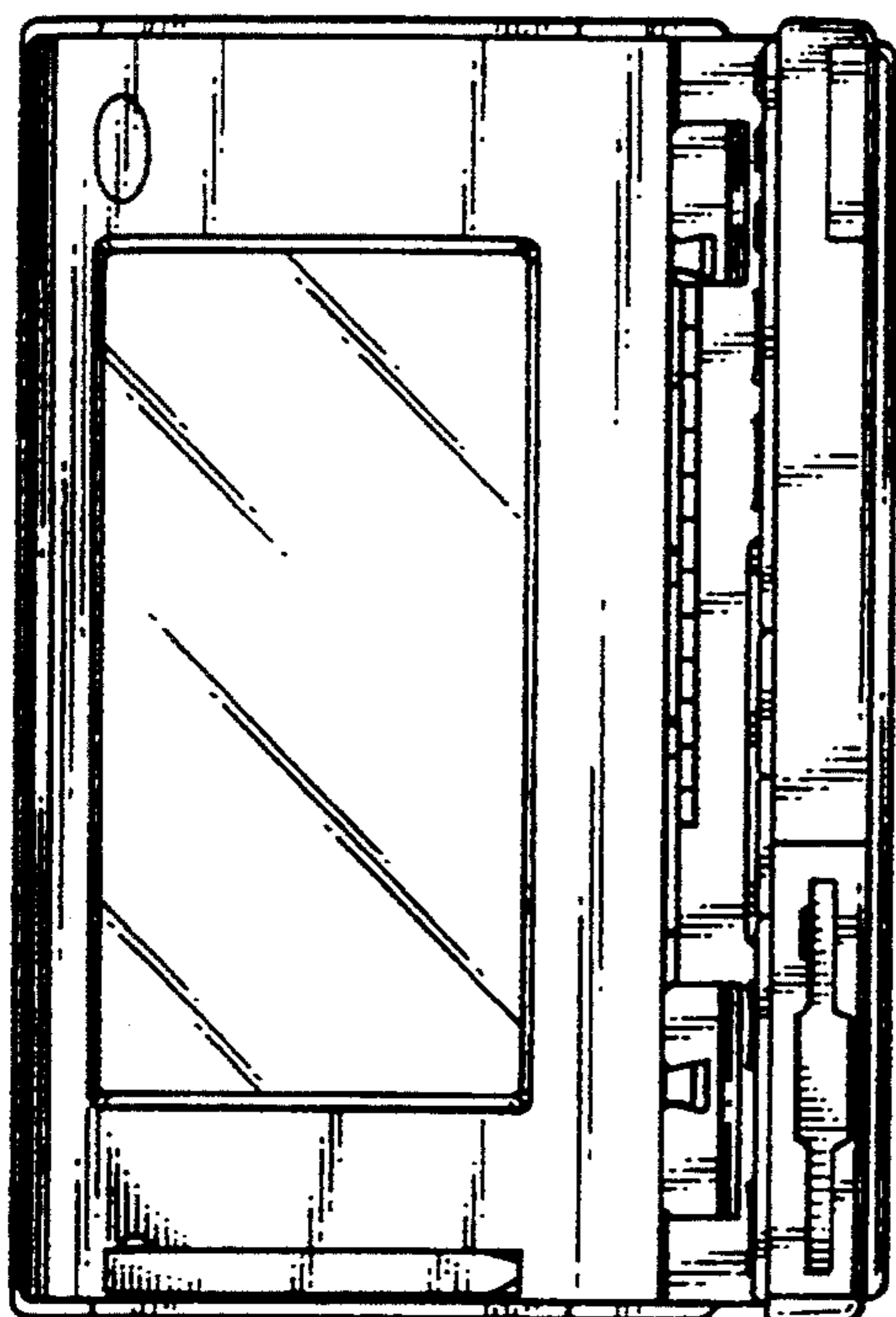

*Fig. 1*



*Fig. 2*

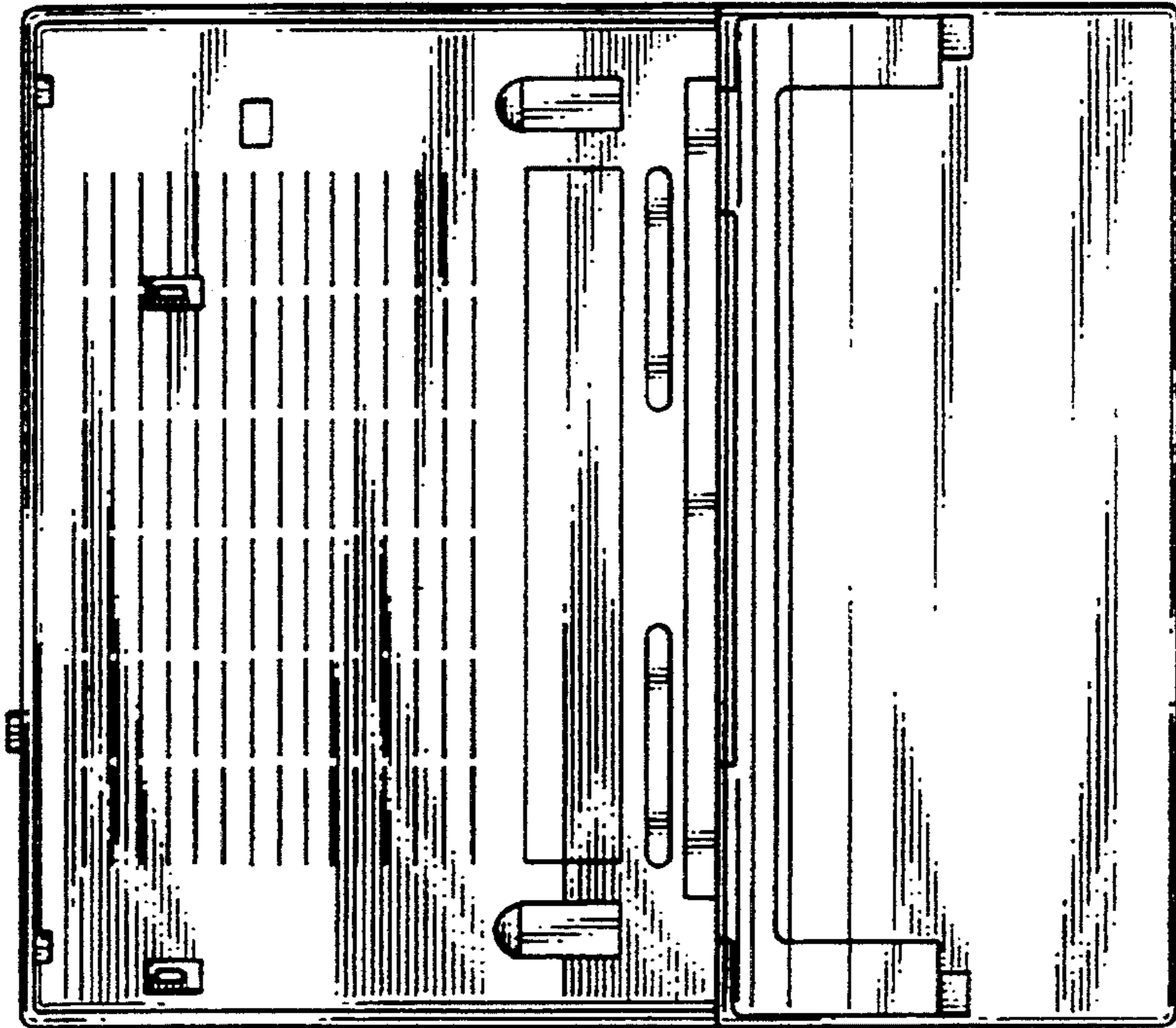

*Fig. 4*

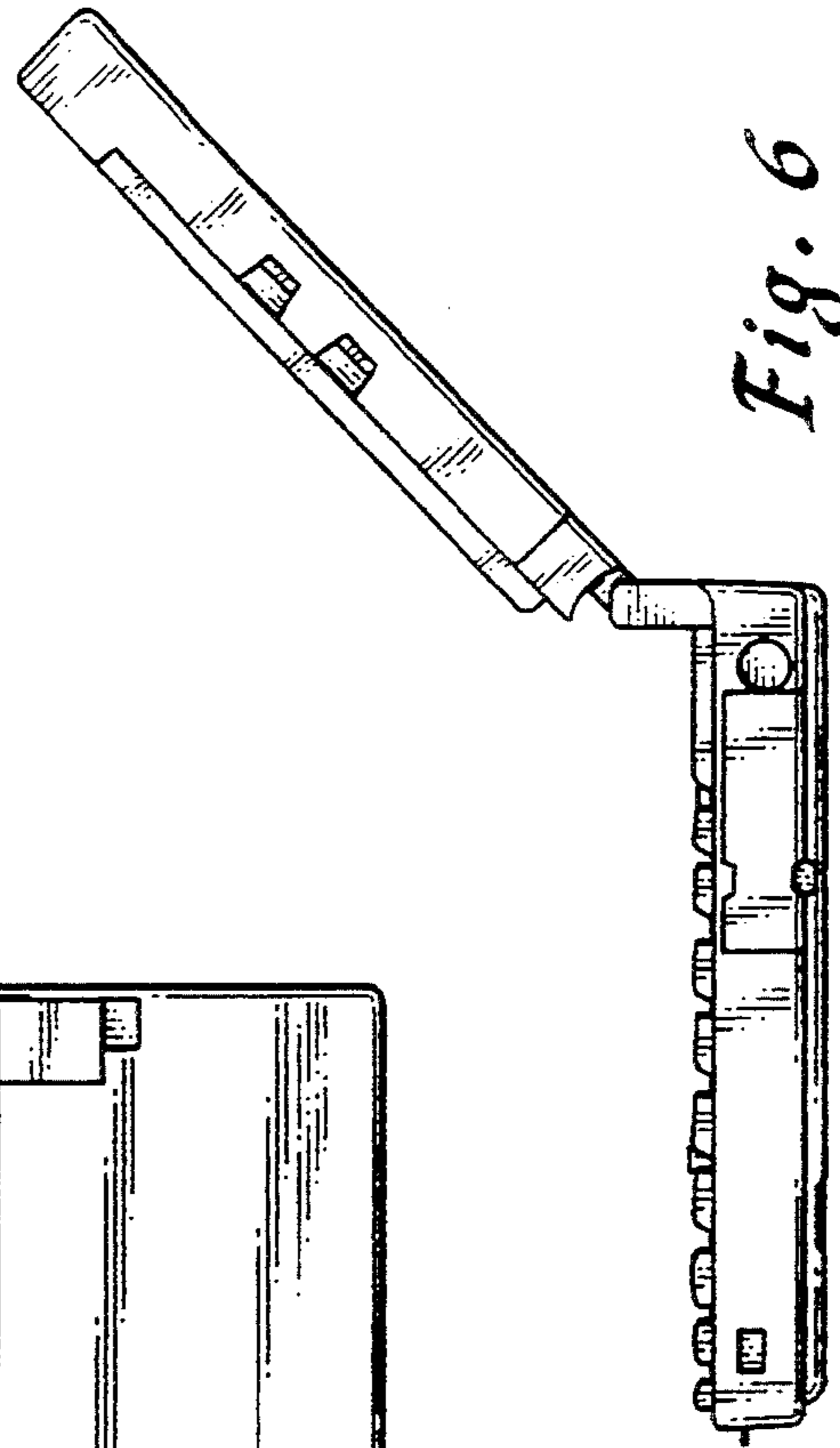

*Fig. 6*

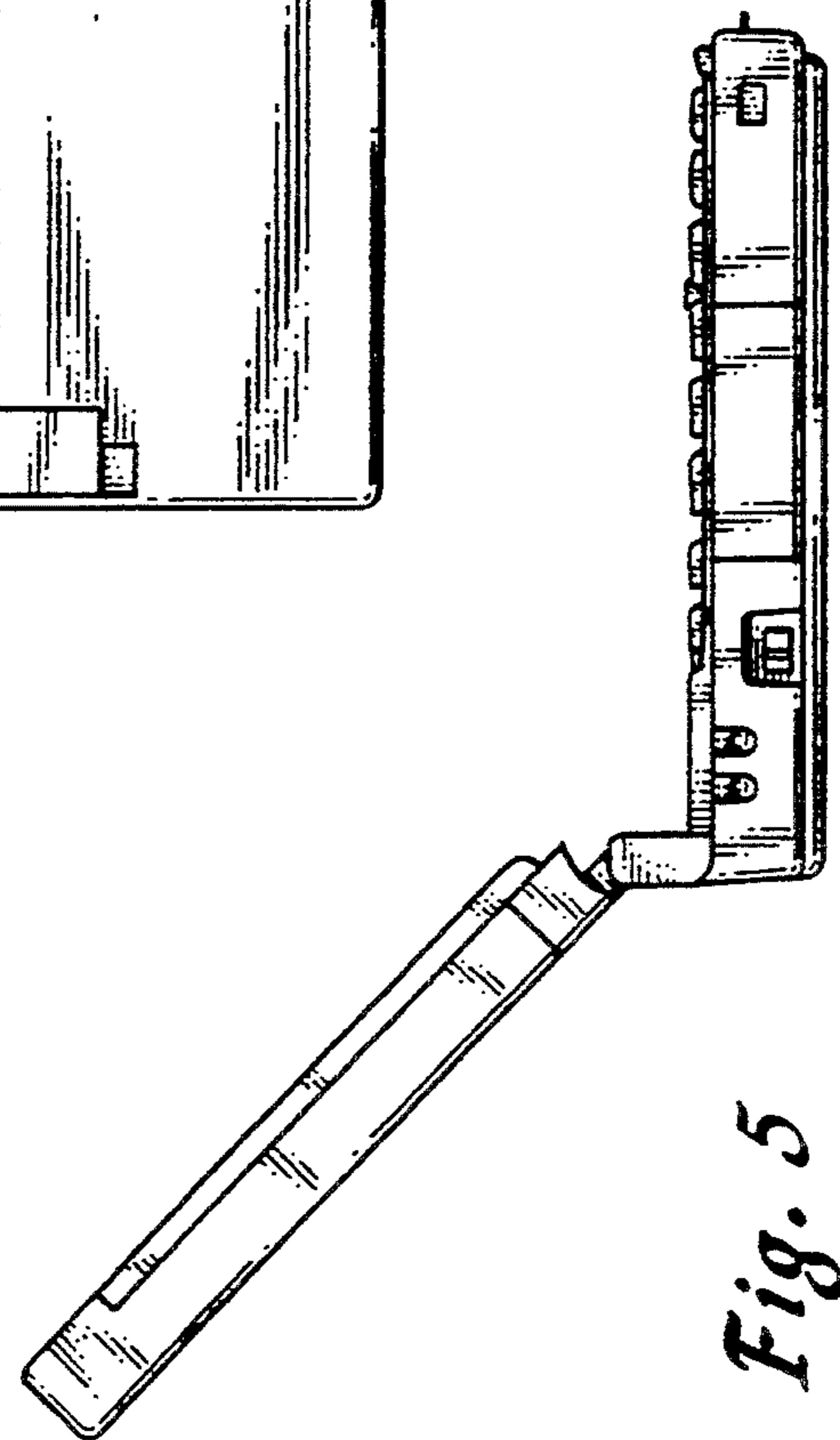

*Fig. 5*

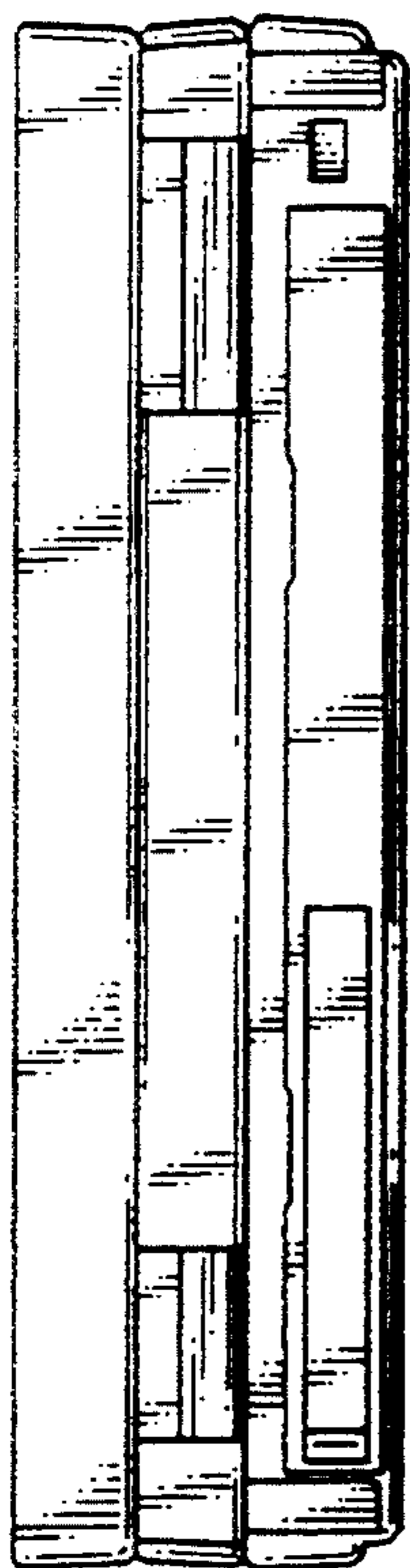

*Fig. 7*

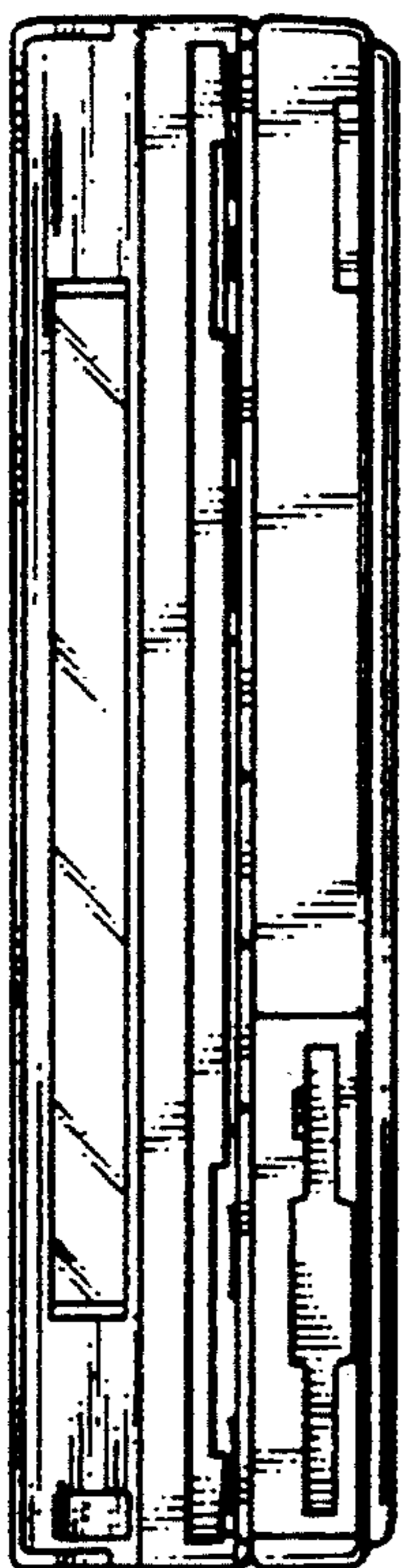

*Fig. 8*

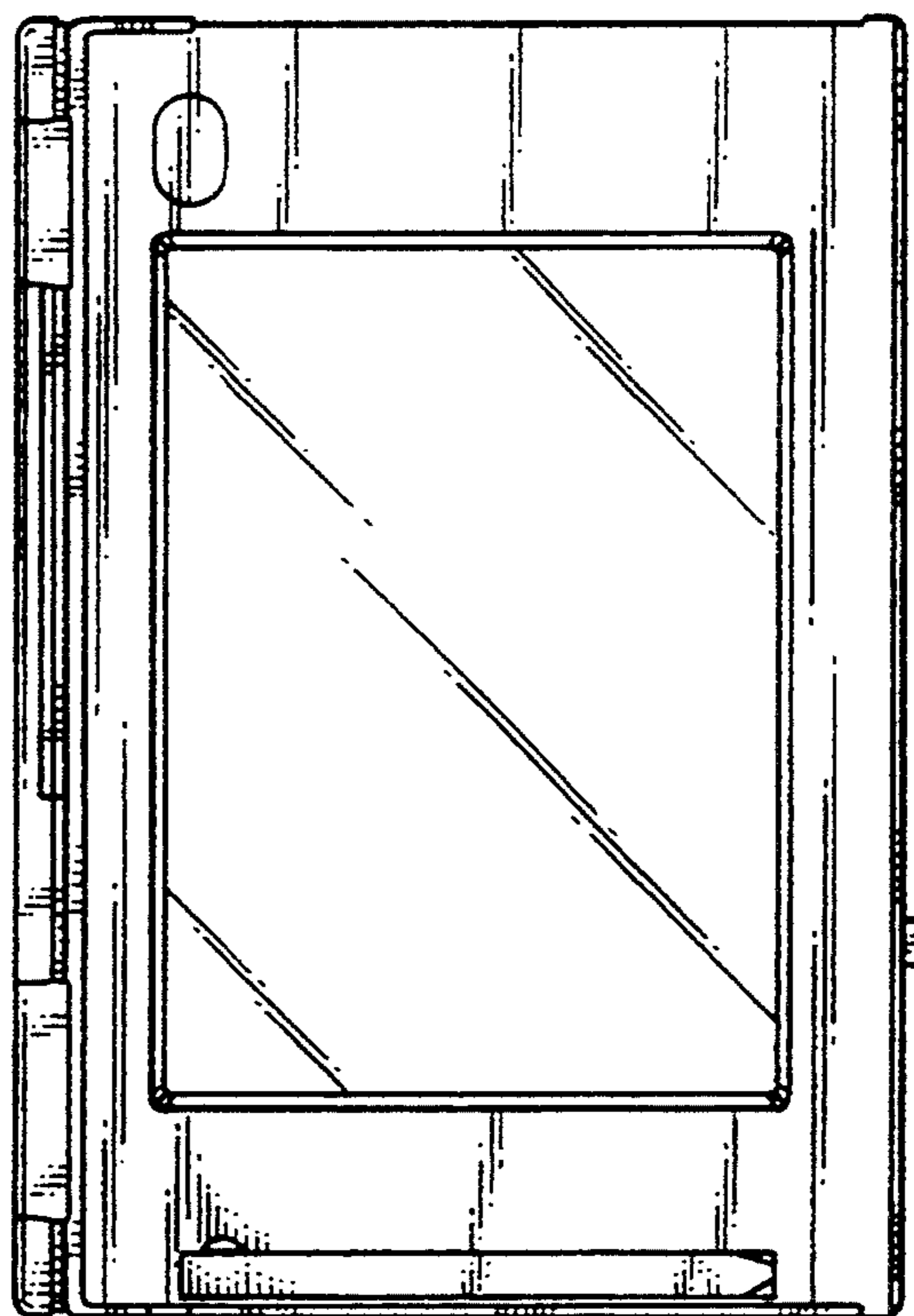

*Fig. 9*

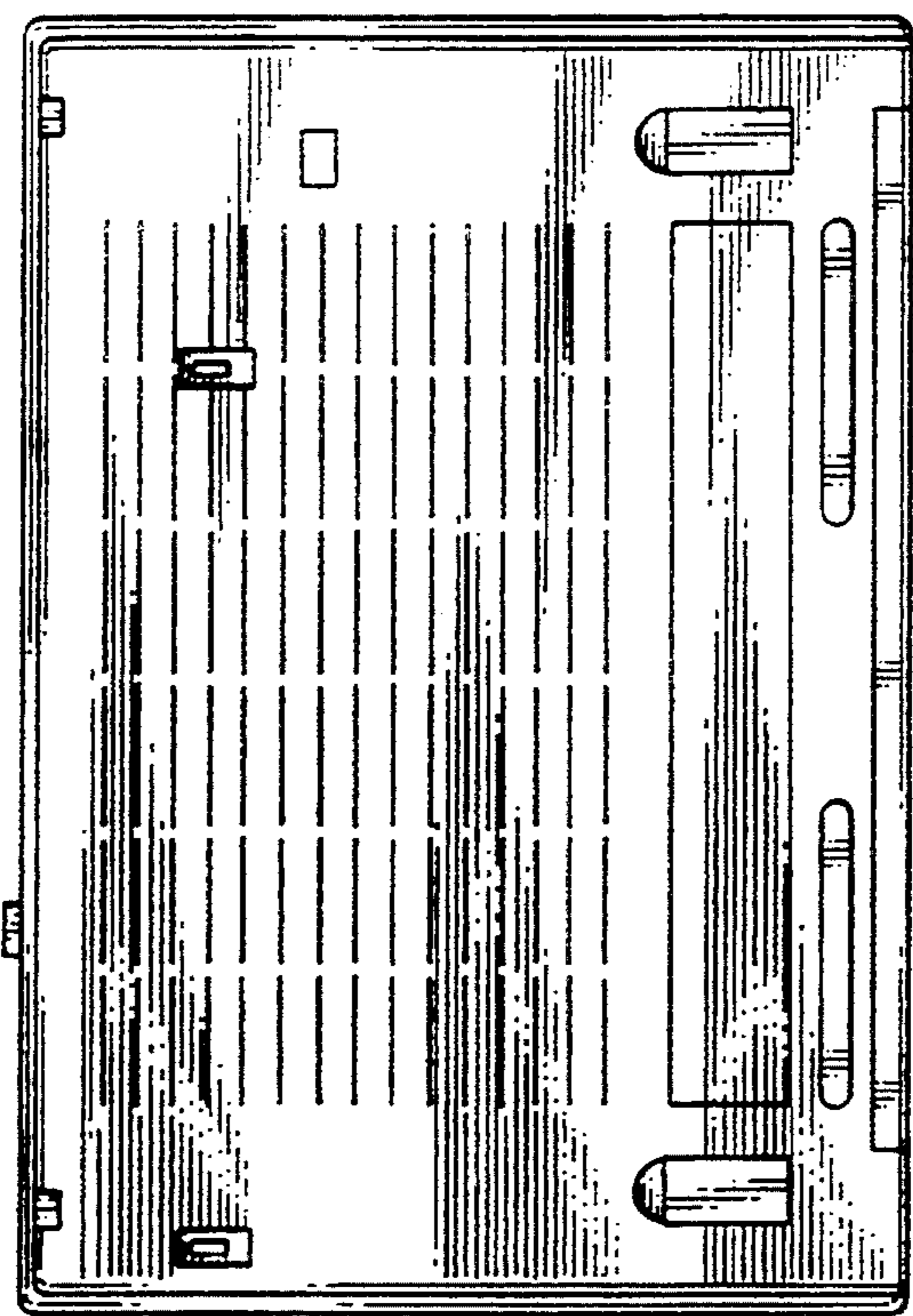

*Fig. 10*

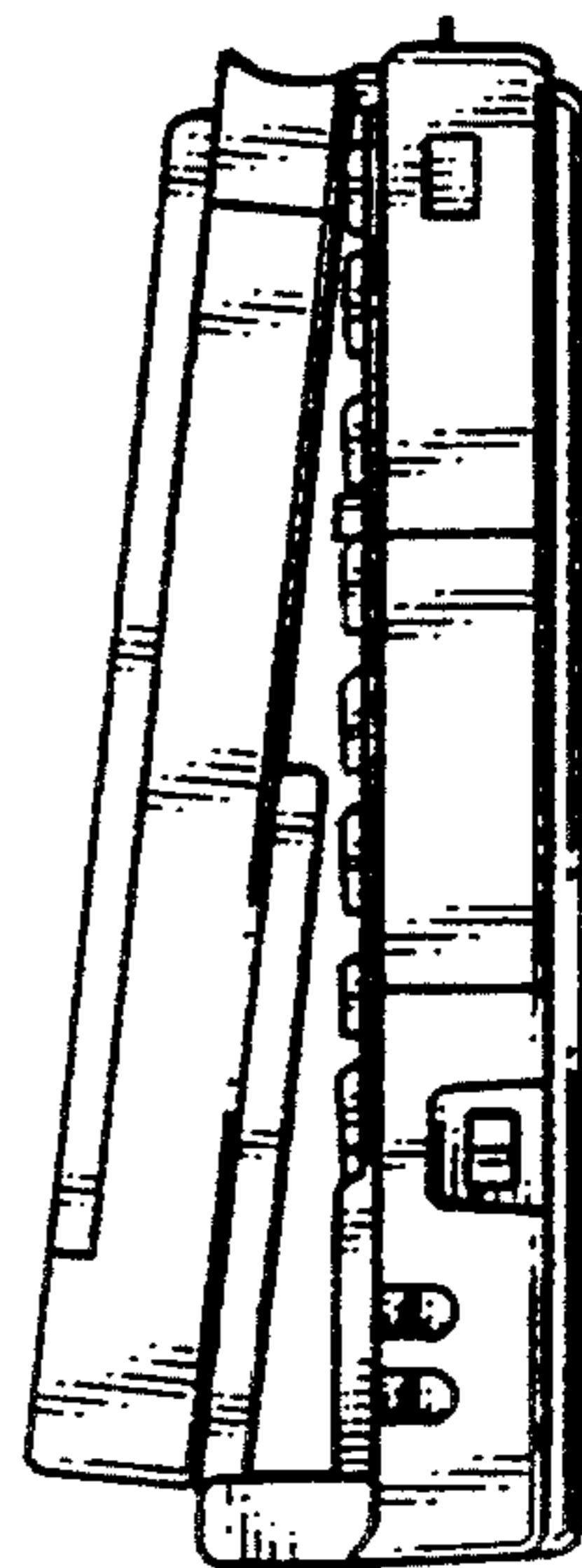

*Fig. 11*

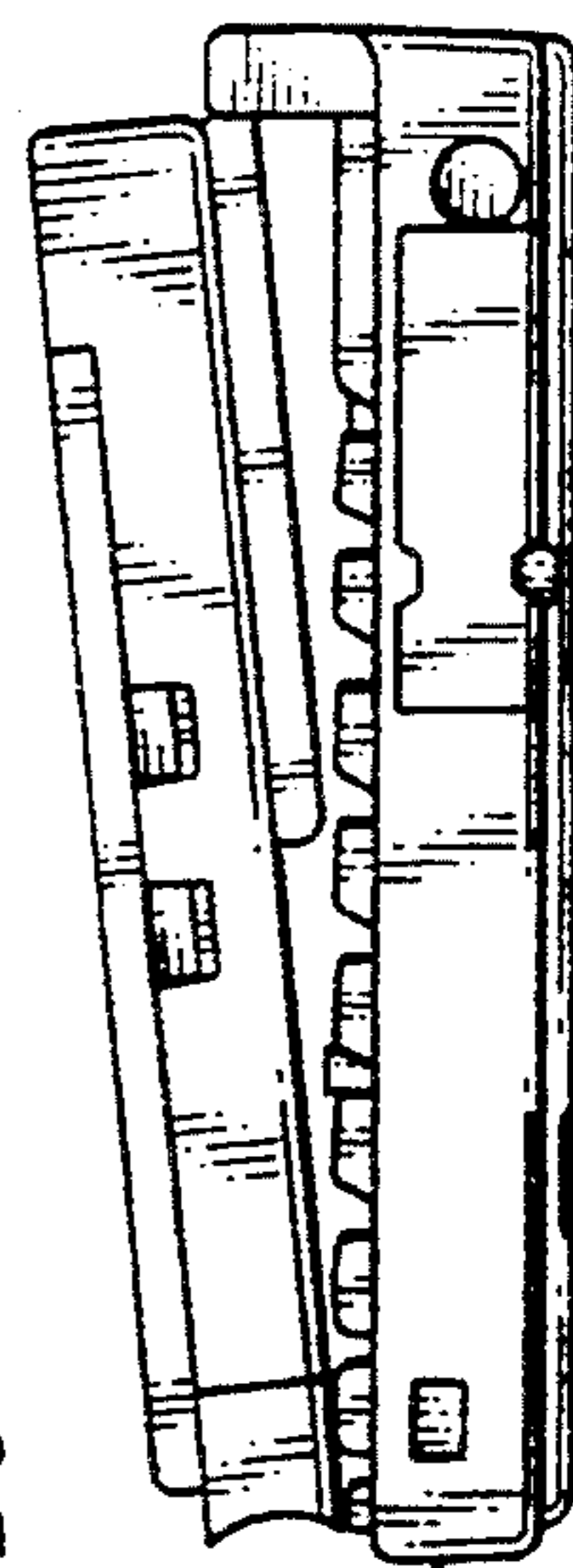

*Fig. 12*

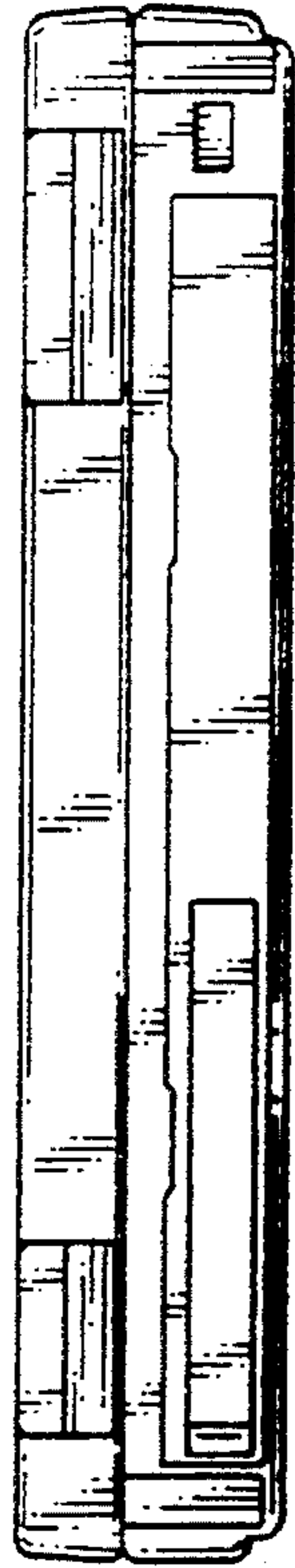

*Fig. 14*

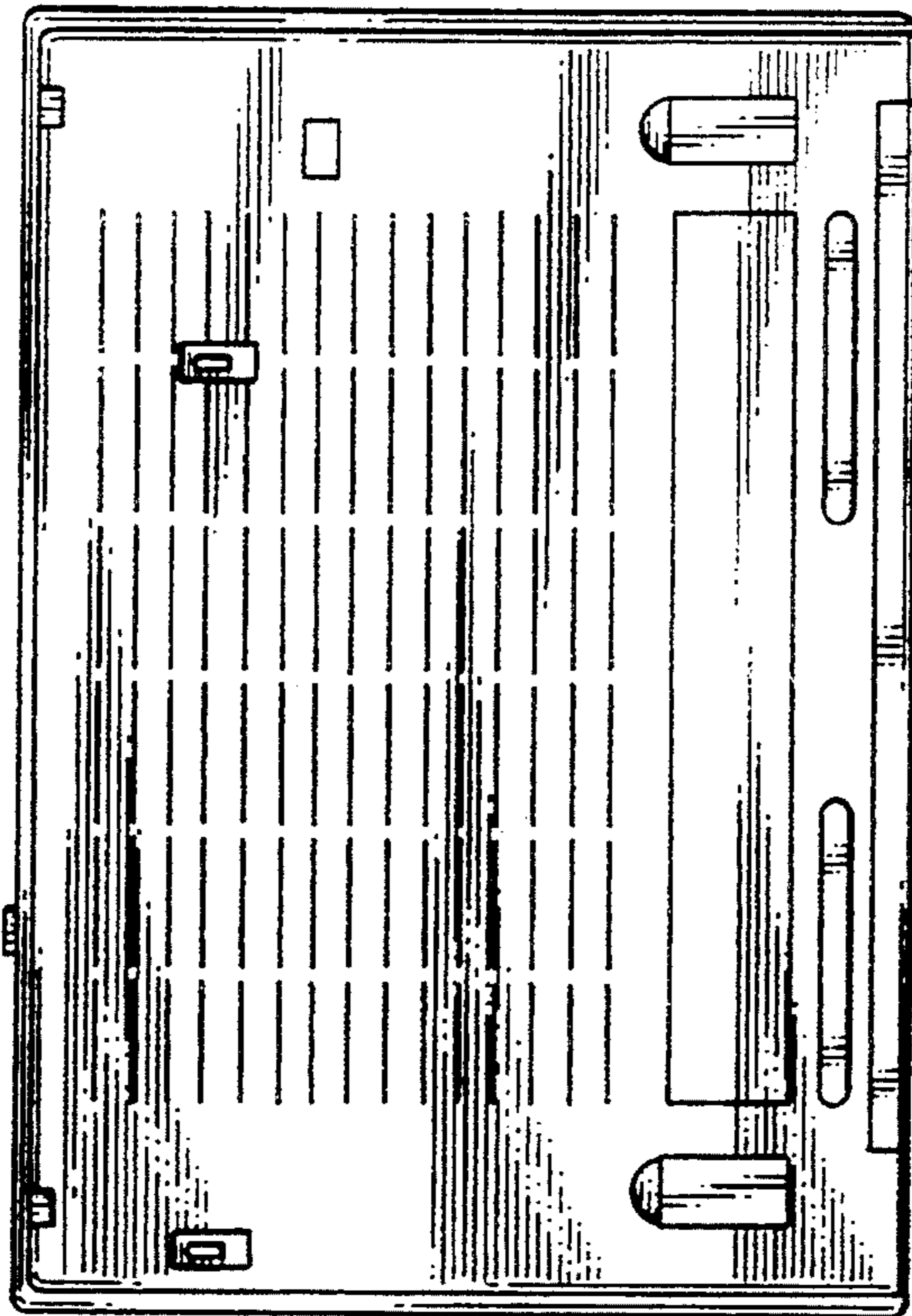

*Fig. 15*

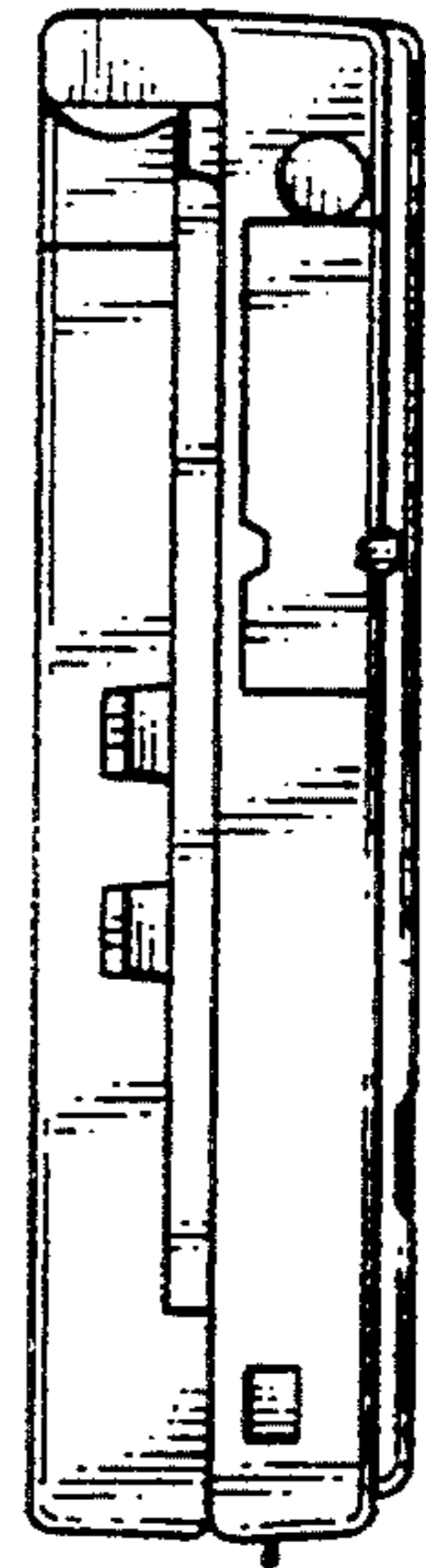

*Fig. 16*



*Fig. 17*

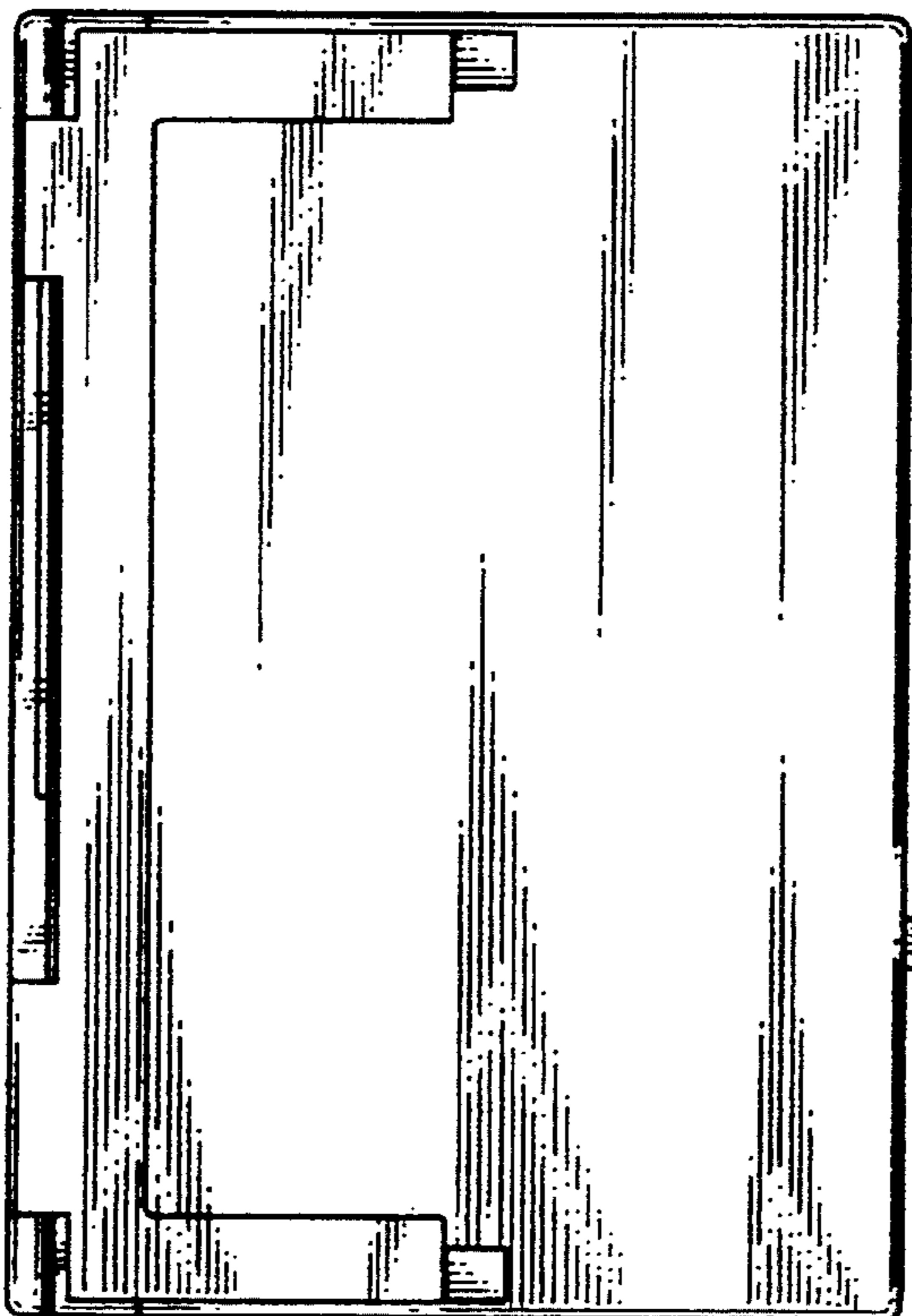

*Fig. 18*

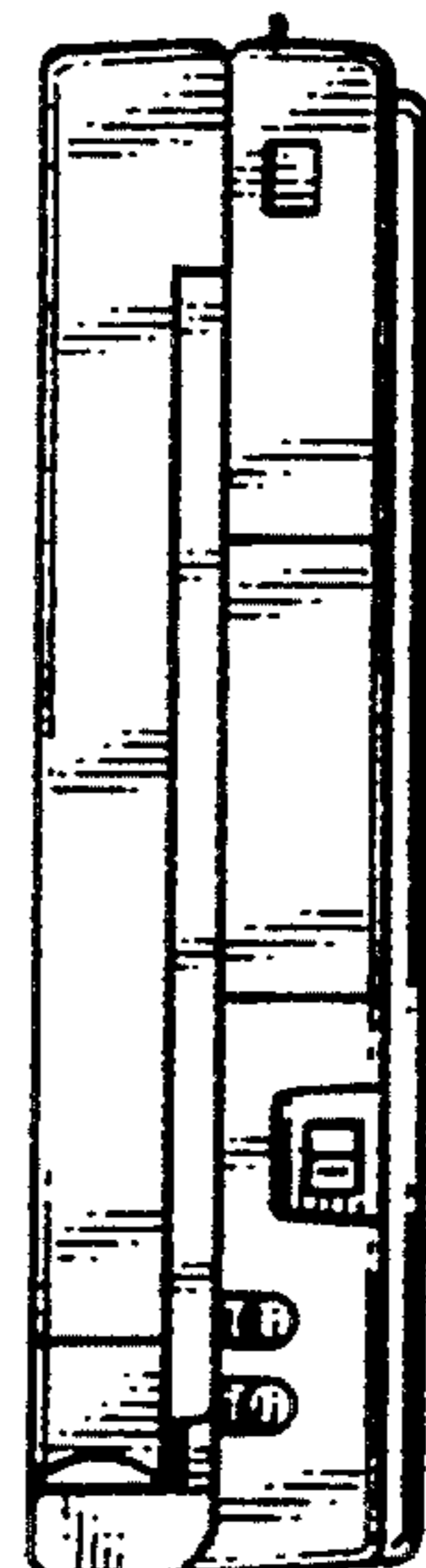

*Fig. 19*

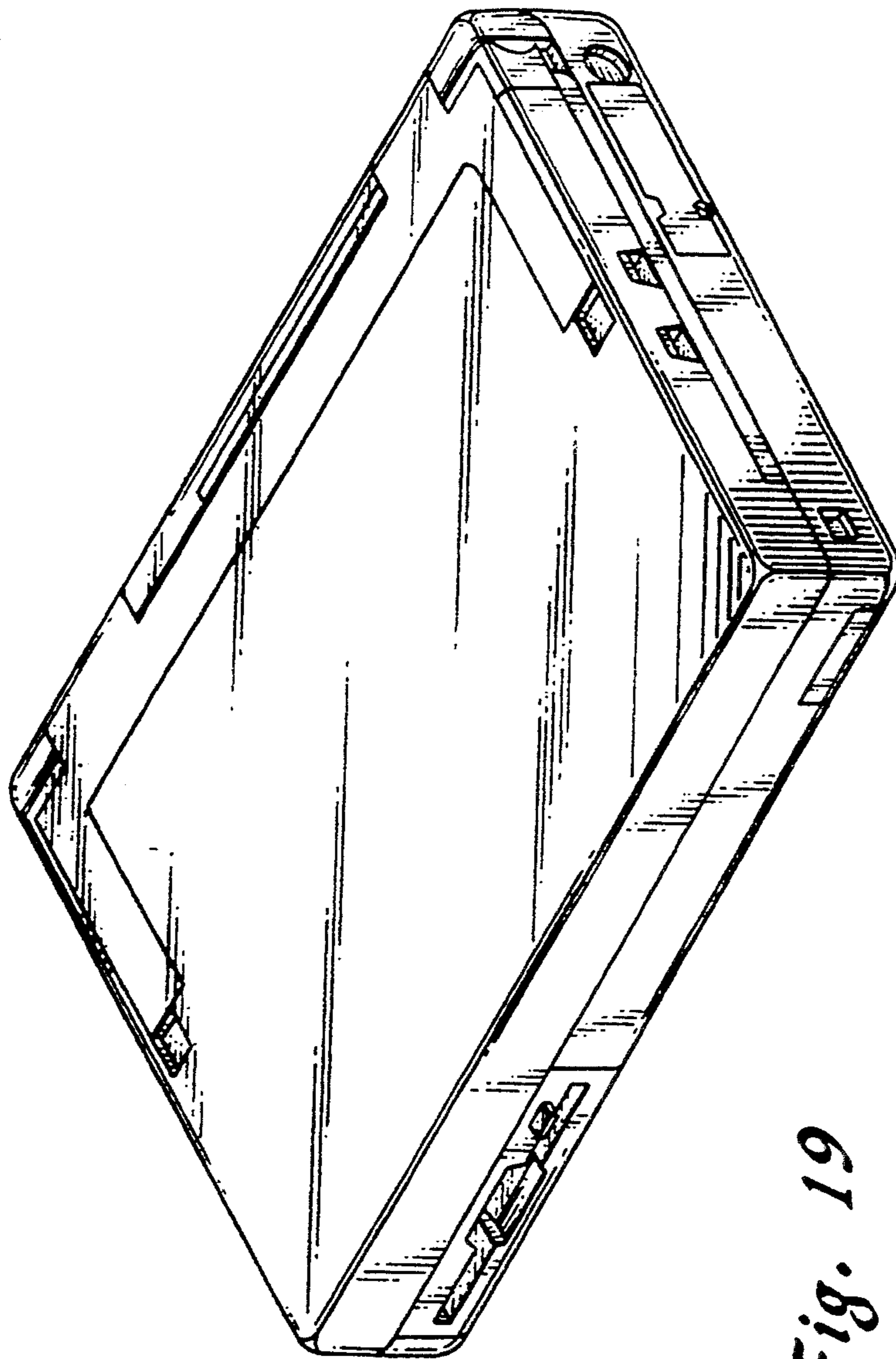

*Fig. 19*