



US00D361296S

United States Patent [19]

[11] Patent Number: **Des. 361,296**

Weder et al.

[45] Date of Patent: **** Aug. 15, 1995**

[54] **FLOWER POT COVER**

[75] Inventors: **Donald E. Weder; Joseph G. Straeter**, both of Highland, Ill.

[73] Assignee: **Highland Supply Corporation**, Highland, Ill.

[*] Notice: The portion of the term of this patent subsequent to Nov. 17, 2008 has been disclaimed.

[**] Term: **14 Years**

[21] Appl. No.: **808,550**

[22] Filed: **Dec. 16, 1991**

Related U.S. Application Data

[63] Continuation-in-part of Ser. No. 710,272, Jun. 4, 1991, which is a continuation-in-part of Ser. No. 617,454, Nov. 21, 1990, abandoned, Ser. No. 411,249, Sep. 22, 1989, Ser. No. 411,247, Sep. 22, 1989, and Ser. No. 411,245, Sep. 22, 1989.

[52] U.S. Cl. **D11/164; D11/143**

[58] Field of Search **D11/143, 152, 153, 154, D11/155, 156, 164; 47/66, 72; 206/423; 215/100.5; 229/1.5 B, 4.5, 922; 248/27.8, 35.1, 542.6**

[56] References Cited

U.S. PATENT DOCUMENTS

D. 47,800	9/1915	Pick .	
D. 132,559	5/1942	Sawyer	D11/153
D. 209,788	11/1978	Affel .	
D. 254,659	4/1980	Karotseris	D11/143
D. 287,950	1/1987	Weder et al.	D11/143
D. 289,024	3/1987	Vaughn	D11/164

(List continued on next page.)

FOREIGN PATENT DOCUMENTS

103316	3/1938	Australia	229/922
560532	4/1975	Switzerland .	

OTHER PUBLICATIONS

Exhibit A—Speed Cover® Brochure—The Simple Solution . . . , ©1989.

Exhibit A. Curtis Wagner Co., Inc., Houston, Tex., shows thick, stiff shiny red plastic pot cover with large scalloped border. (Photograph) Date unknown.

Exhibit B. Jacobson Pot Cover Company of Scranton,

Pa. advertising literature. Date of first use unknown.

Exhibit C. Photograph of pot cover, manufacturer un- (List continued on next page.)

Primary Examiner—Martie Thompson
Attorney, Agent, or Firm—Dunlap & Coddling

[57] CLAIM

The ornamental design for a flower pot cover, as shown and described.

DESCRIPTION

FIG. 1 is a perspective view of our new flower pot cover design;

FIG. 2 is a reduced top plan view thereof;

FIG. 3 is a reduced bottom plan view thereof;

FIG. 4 is a reduced side elevational view thereof;

FIG. 5 is a reduced side elevation view of the design view of the design of FIG. 1, the only difference being the angle of the skirt;

FIG. 6 is a perspective view of a second embodiment of our new design;

FIG. 7 is a reduced top plan view of the design of FIG. 6;

FIG. 8 is a reduced bottom plan view of the design of FIG. 6;

FIG. 9 is a reduced side elevational view of the design of FIG. 6, the only difference being the angle of the skirt;

FIG. 10 is a reduced side elevation view of the design of FIG. 6, the only difference being the angle of the skirt;

FIG. 11 is a perspective view of a third embodiment of our new design;

FIG. 12 is a reduced top plan view of the design of FIG. 11;

FIG. 13 is a reduced bottom plan view of the design of FIG. 11;

FIG. 14 is a reduced side elevational view of the design of FIG. 11, the only difference being the angle of the skirt; and,

FIG. 15 is a reduced side elevation view of the design of FIG. 11, the only difference being the angle of the skirt.

The flower pot cover has no substantial thickness.

The characteristic feature of the design resides in the specific pleating arrangement comprised of the parallel disposition of the exterior folds in combination with the interior V-shaped folds, all as best shown in FIG. 1.

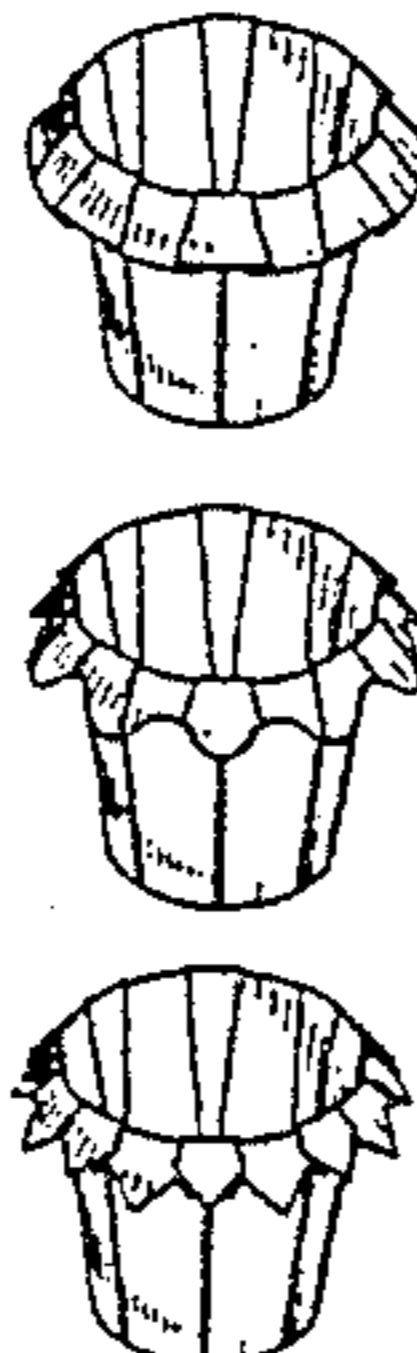

U.S. PATENT DOCUMENTS

D. 289,982	5/1987	Weder et al.	D11/164
D. 292,182	5/1987	Weder et al.	D11/164
D. 292,183	10/1987	Weder et al.	D11/164
D. 292,184	10/1987	Weder et al.	D11/164
D. 292,185	10/1987	Weder et al.	D11/164
D. 292,186	10/1987	Weder et al.	D11/164
D. 292,187	10/1987	Weder et al.	D11/164
D. 292,188	10/1987	Weder et al.	D11/164
D. 292,189	10/1987	Weder et al.	D11/164
D. 292,190	10/1987	Weder et al.	D11/164
D. 292,191	10/1987	Weder et al.	D11/164
D. 292,561	11/1987	Weder et al.	D11/164
D. 292,562	11/1987	Weder et al.	D11/164
D. 292,563	11/1987	Weder et al.	D11/164
D. 293,222	12/1987	Weder et al.	D11/164
D. 293,223	12/1987	Weder et al.	D11/164
D. 293,224	12/1987	Weder et al.	D11/164
D. 293,304	12/1987	Weder et al.	D11/164
D. 293,305	12/1987	Weder et al.	D11/164
D. 293,306	12/1987	Weder et al.	D11/164
D. 293,307	12/1987	Weder et al.	D11/164
D. 293,308	12/1987	Weder et al.	D11/164
D. 293,774	1/1988	Weder et al.	D11/164
D. 293,775	1/1988	Weder et al.	D11/164
D. 296,535	7/1988	Weder et al.	D11/149
D. 297,422	8/1988	Weder et al.	D11/164
D. 298,017	10/1988	Weder et al.	D11/164
D. 301,565	6/1989	Weder	D11/152
D. 302,139	7/1989	Weder	D11/153
D. 302,253	7/1989	Weder	D11/153
D. 302,254	7/1989	Weder	D11/153
D. 302,404	7/1989	Weder	D11/153
D. 302,405	7/1989	Weder	D11/155
D. 302,406	7/1989	Weder	D11/155
D. 302,407	7/1989	Weder	D11/155
D. 303,759	10/1989	Mileos	D9/306
D. 303,775	10/1989	Weder	D11/155
D. 313,376	1/1991	Weder	D11/164
D. 313,573	1/1991	Weder et al.	D11/164
D. 313,574	1/1991	Weder et al.	D11/164
D. 313,575	1/1991	Weder et al.	D11/164
D. 313,576	1/1991	Weder	D11/164
D. 314,732	2/1991	Weder	D11/164
D. 315,534	3/1991	Weder et al.	D11/164
D. 315,878	4/1991	Weder et al.	D11/164
D. 315,879	4/1991	Weder et al.	D11/164
D. 315,880	4/1991	Weder et al.	D11/164
D. 315,881	4/1991	Weder et al.	D11/164
D. 315,882	4/1991	Weder	D11/164
D. 315,883	4/1991	Weder	D11/164
D. 316,060	4/1991	Weder	D11/164
D. 316,061	4/1991	Weder	D11/164
D. 316,062	4/1991	Weder et al.	D11/164
D. 316,837	5/1991	Weder et al.	D11/164
D. 316,838	5/1991	Weder et al.	D11/164
D. 316,985	5/1991	Weder	D11/164
D. 317,424	6/1991	Weder	D11/164
D. 317,582	6/1991	Weder	D11/164
D. 317,583	6/1991	Weder et al.	D11/164
D. 318,029	7/1991	Weder	D11/164
D. 318,030	7/1991	Weder et al.	D11/164
D. 318,635	7/1991	Weder et al.	D11/164
D. 319,034	8/1991	Weder et al.	D11/164

(List continued on next page.)

OTHER PUBLICATIONS

known, but very similar to #C21 on Exhibit B (Jacobson literature). Date unknown.

Exhibit D. Photocopy of photo of pot cover ("Platform Pot Dresser") made by John Raisen Corp., San Francisco, Calif. Date of first use unknown.

Exhibit E. Photograph of 2-part pot cover system made by Floral Decor, subsidiary of John Henry Co., Lansing, Mich. Date unknown.

Exhibit F. Photo of pot cover made by a Holland company (K.P.I.). Date of first public use believed to be late 1984.

Exhibit G. "The Glass of Frederick Carder", copyright 1971 by P. V. Gardner, showing various styles of glass basket-like vases or containers.

Exhibit H. "Speed Cover®" brochure, published in

(List continued on next page.)

U.S. PATENT DOCUMENTS

D. 319,417	8/1991	Weder et al.	D11/164
D. 319,991	9/1991	Weder	D11/164
1,065,486	6/1913	Washburn	229/1.5 B
1,069,675	8/1913	Claussen .	
1,446,563	2/1923	Hughes .	
1,520,647	12/1924	Hennegan .	
1,632,347	6/1927	Pipkin .	
1,868,853	7/1932	Sievers .	
1,924,926	8/1933	Gray .	
1,951,642	3/1934	Augustin et al.	47/34
2,054,934	9/1936	Graffenberger	229/1.5 B
2,102,510	12/1937	Cecil, II	229/1.5 B
2,302,259	11/1942	Rothfuss	41/10
2,355,559	8/1944	Renner	229/8
2,482,981	9/1949	Kamrass	41/13
2,570,954	10/1951	Kasman	65/53
2,967,652	1/1961	Canfield et al.	229/5.5
3,022,605	1/1962	Reynolds	47/58
3,232,469	2/1966	Piazzze	215/38
3,271,922	9/1966	Wallerstein et al.	53/3
3,488,022	1/1970	Vittori	248/152
3,542,616	11/1970	Cain et al.	156/224
3,820,684	6/1974	Harrison	206/520
3,962,503	6/1976	Crawford	428/40
4,043,077	8/1977	Stonehocker	47/66
4,118,890	10/1978	Shore	47/28
4,170,618	10/1979	Adams	264/101
4,216,620	8/1980	Weder et al.	47/72
4,300,312	11/1981	Weder et al.	47/72

4,408,644	10/1983	Svantesson	150/55
4,413,725	11/1983	Bruno et al.	206/45.33
4,508,223	4/1985	Catrambone	206/423
4,712,725	12/1987	Moore	229/8
4,733,521	3/1988	Weder et al.	53/580
4,773,182	9/1988	Weder et al.	47/72
4,795,601	1/1989	Cheng	264/138
4,813,862	3/1989	Bowers et al.	425/87
4,835,834	6/1989	Weder	29/525

OTHER PUBLICATIONS

1983 by Applicants, showing various pot covers for sale.

Exhibit I. "Speed Cover®" brochure, published in 1983 by Applicants, showing various pot covers for sale.

Exhibit J. Item published in 1936 by Gellman Bros., Minneapolis, Minn. Shows an assortment of paper hats.

Exhibit K. Photo of various other flower pot wrappings, sold in rolls or sheets and used in the floral industry for years. Date unknown.

Exhibit L. Photo of pot cover made of woven straw--like material. Date unknown.

Exhibit M. Photo of basket-type pot cover used in the floral industry. Date unknown.

Exhibit N. "Speed Cover®" brochure, published in 1984 by Applicants, showing various pot covers for sale.

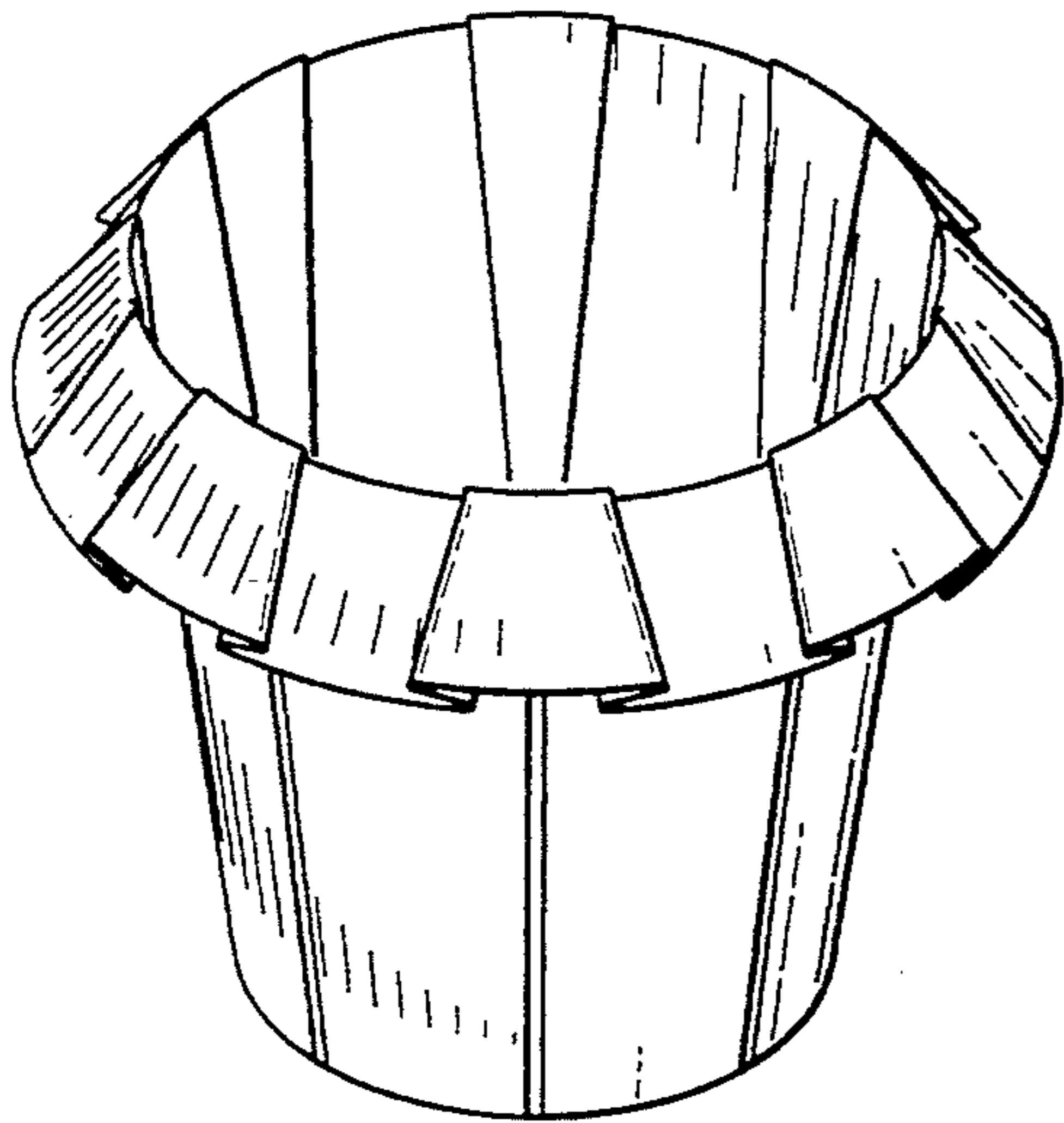

FIG. 1

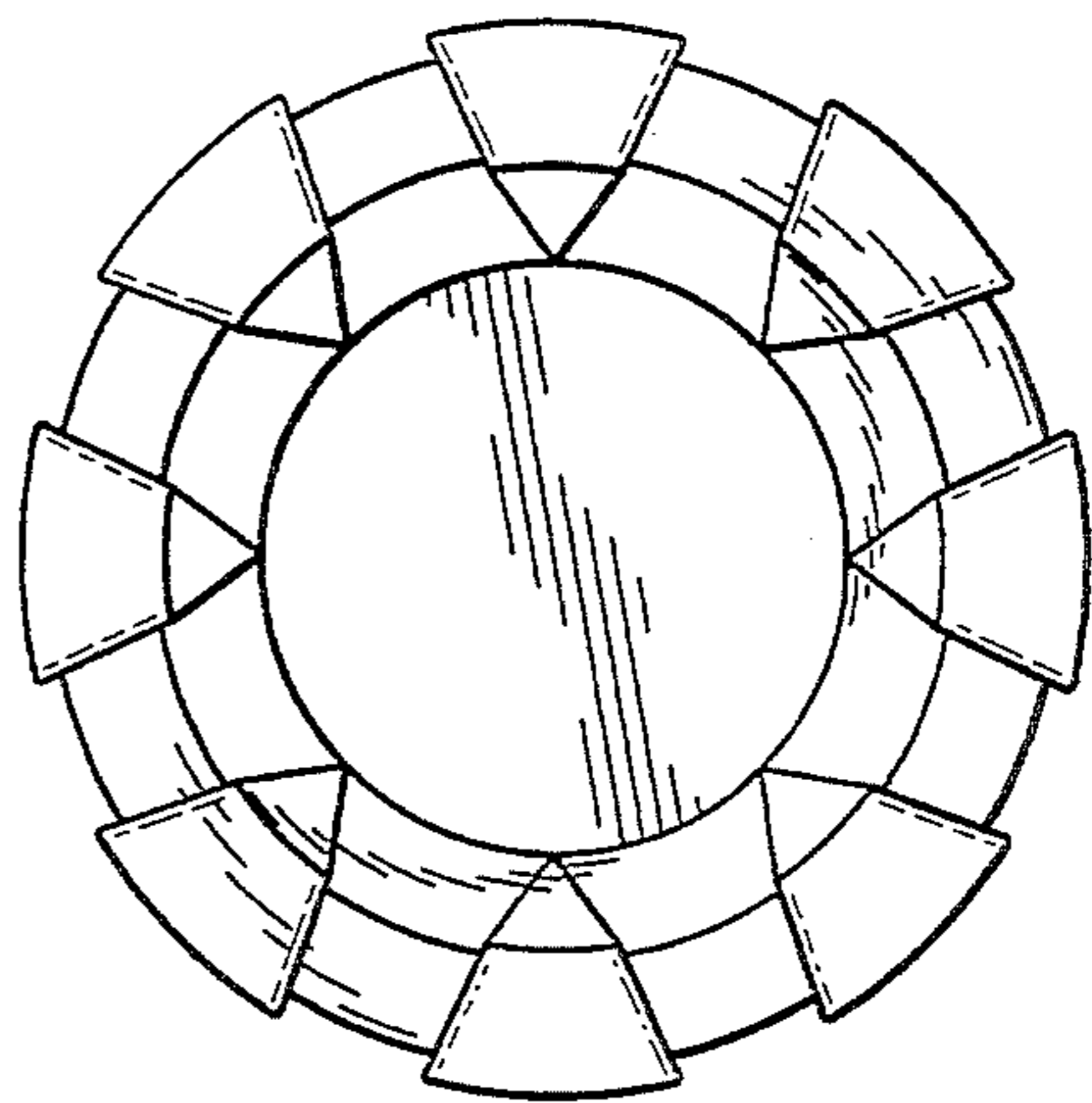

FIG. 2

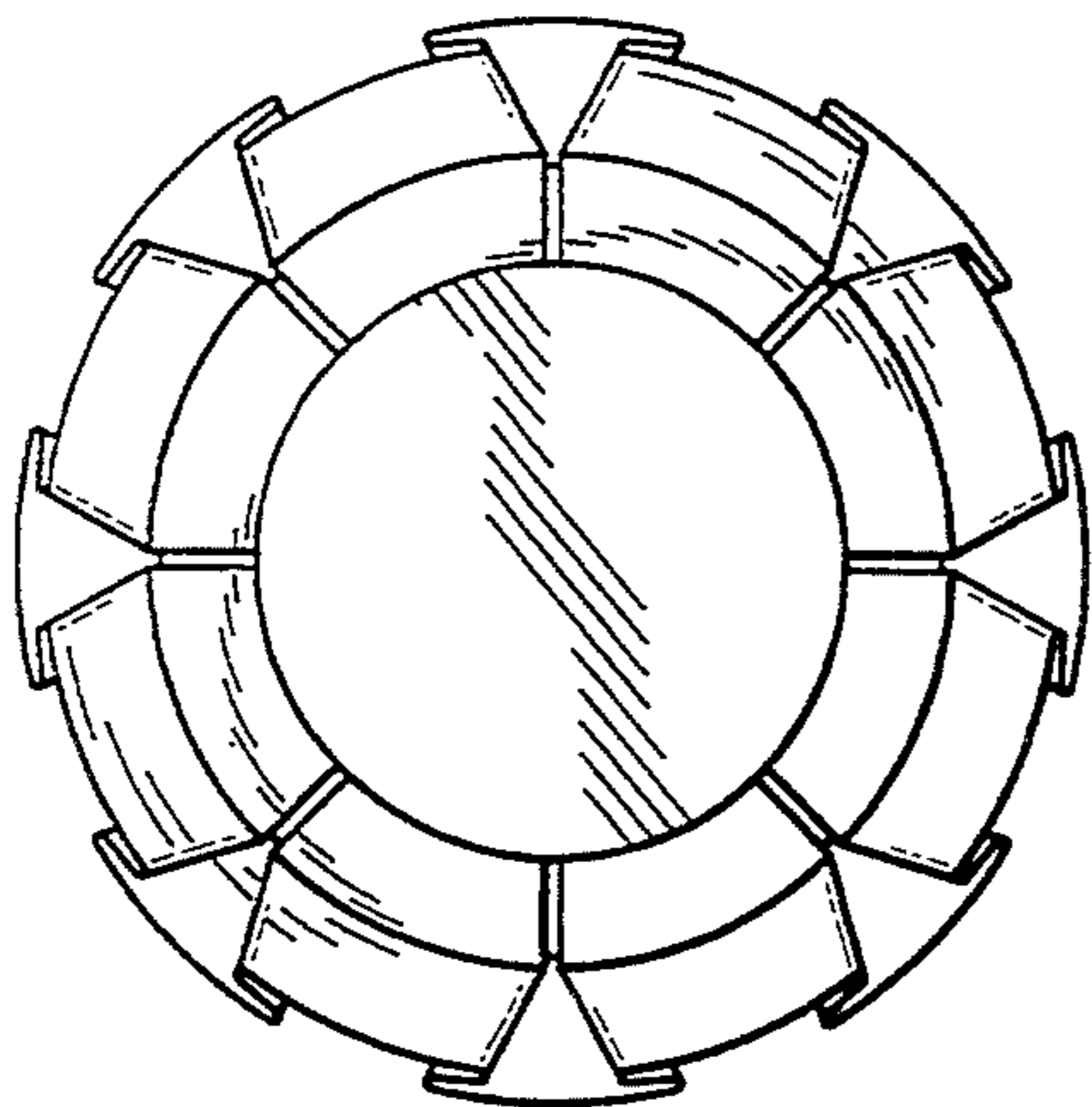

FIG. 3

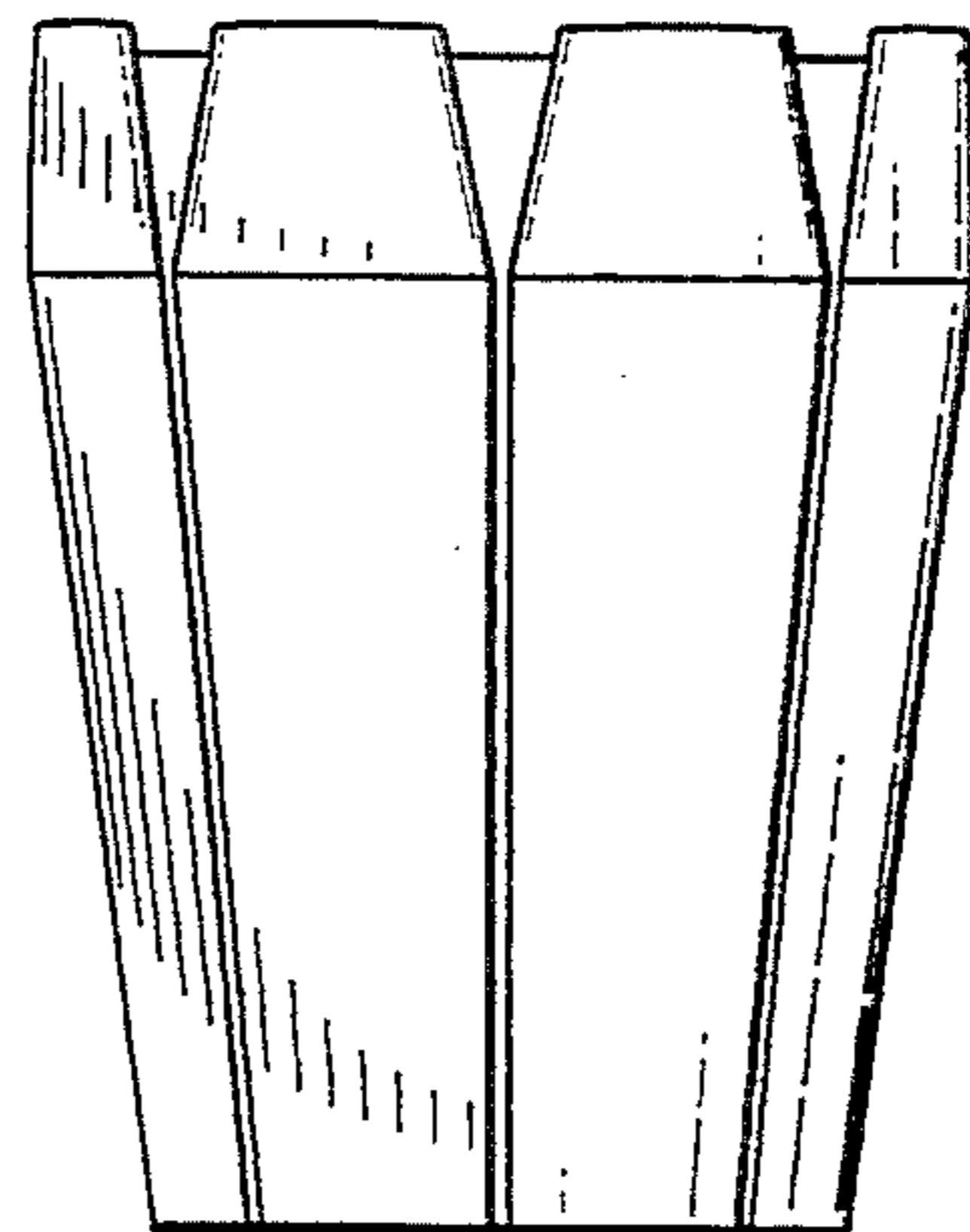

FIG. 4

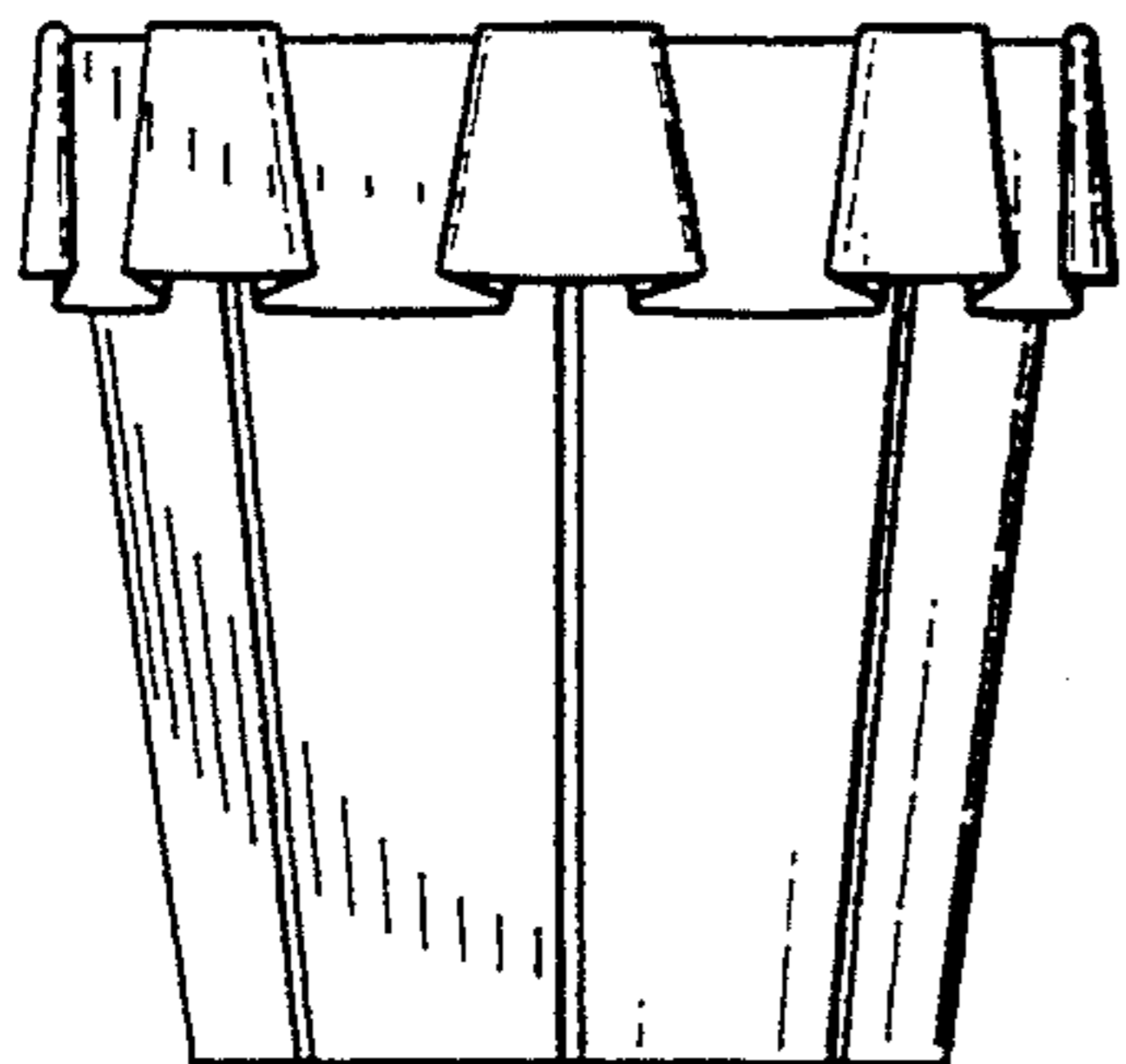

FIG. 5

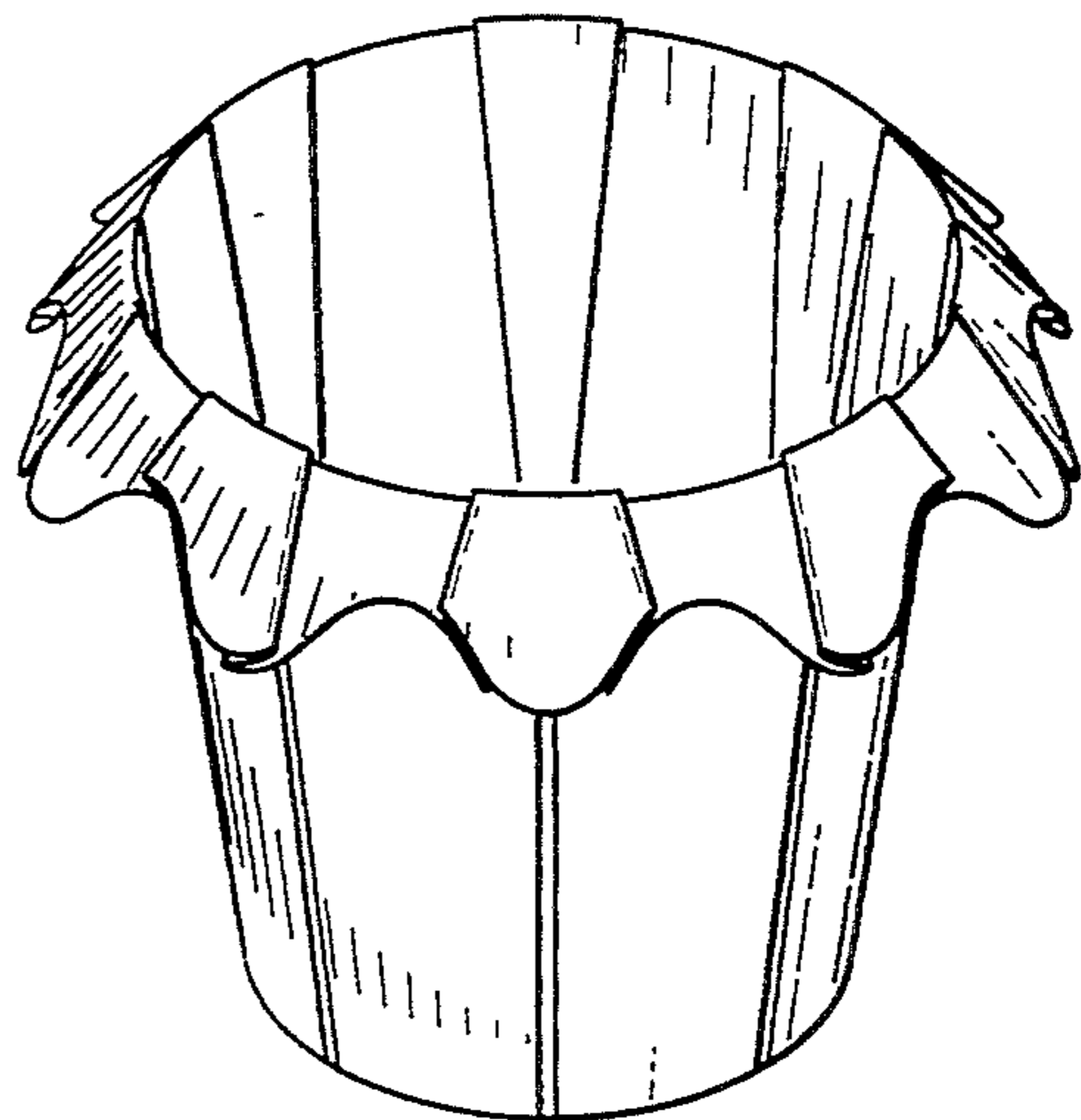

FIG. 6

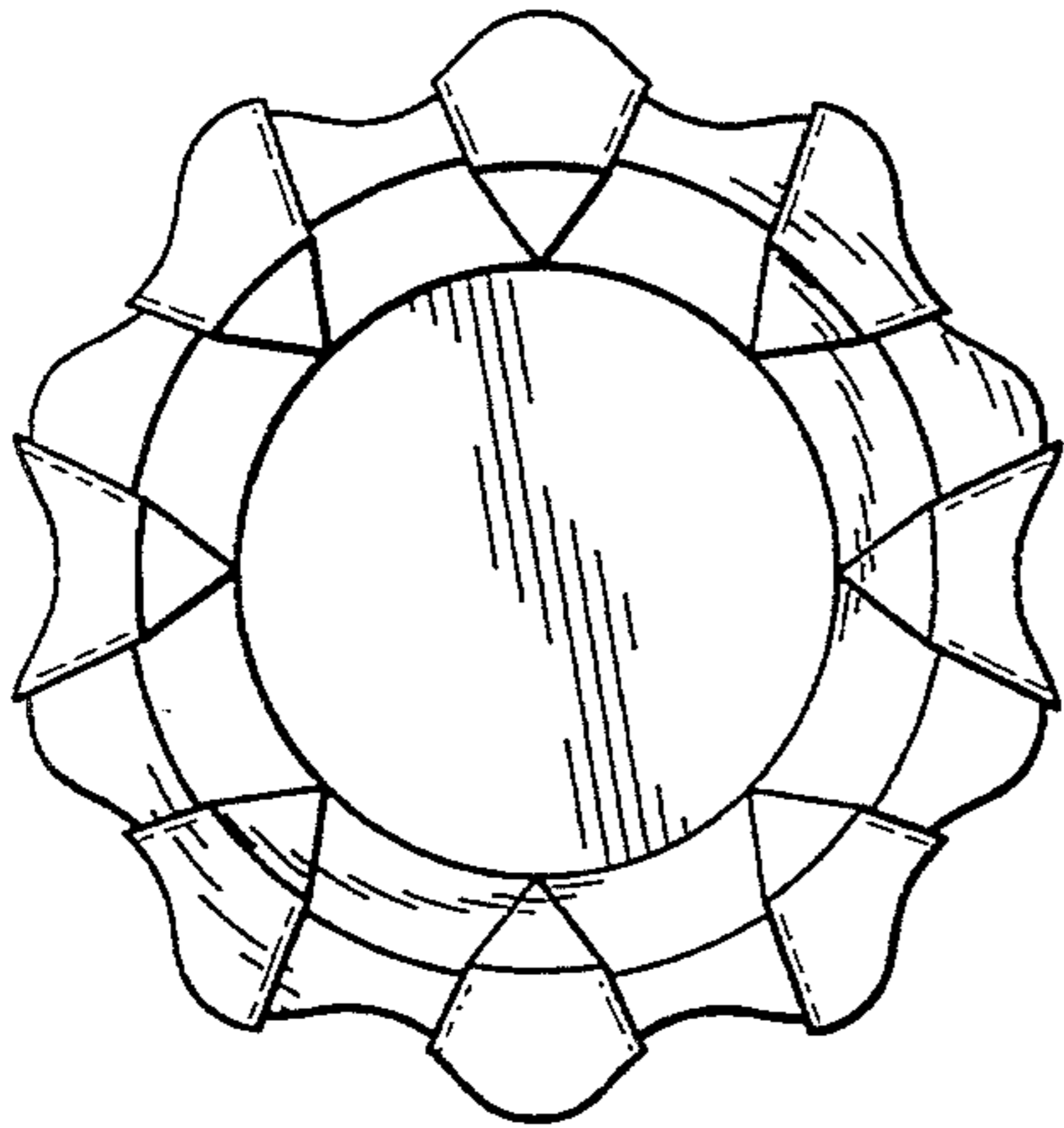

FIG. 7

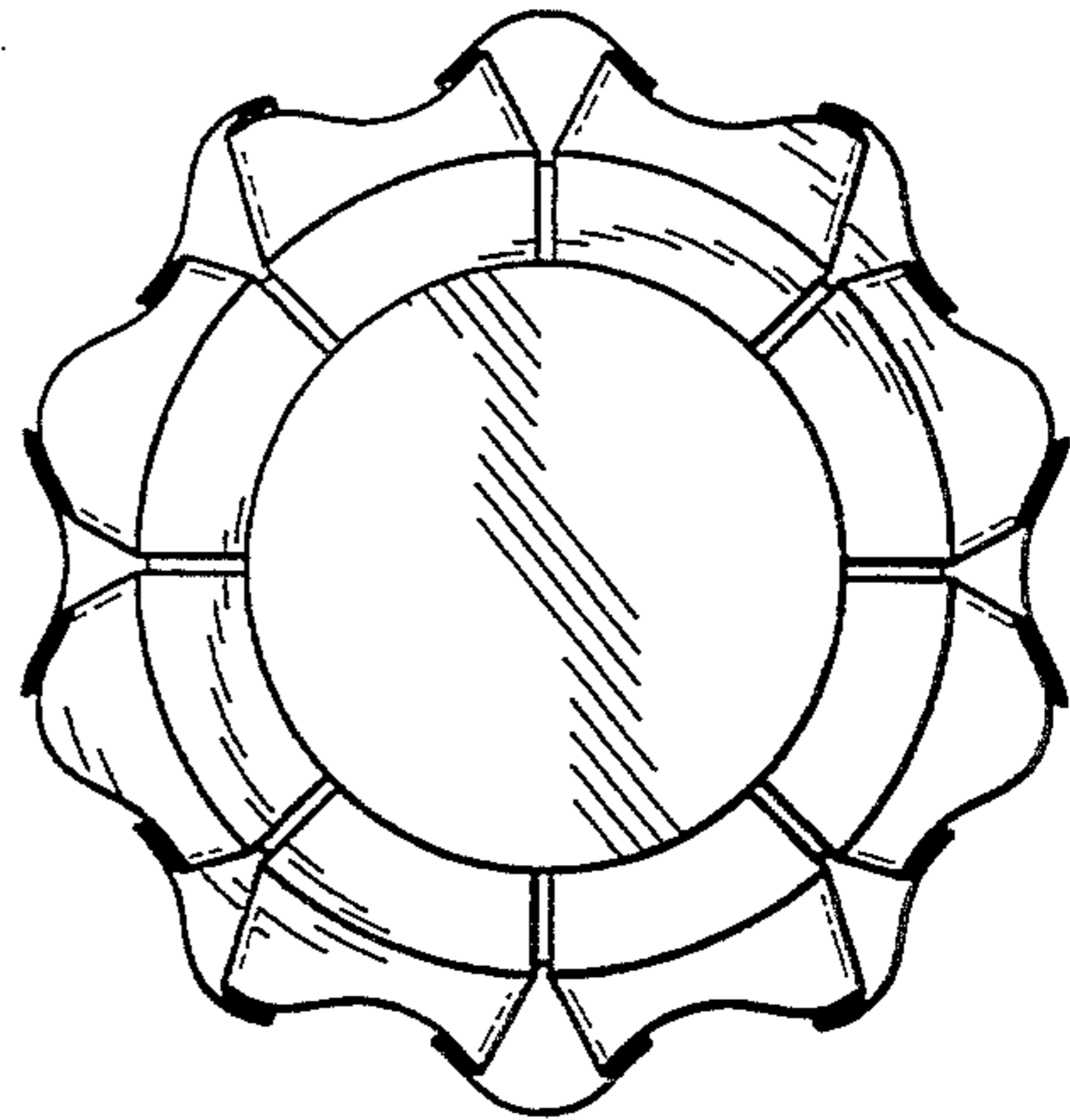

FIG. 8

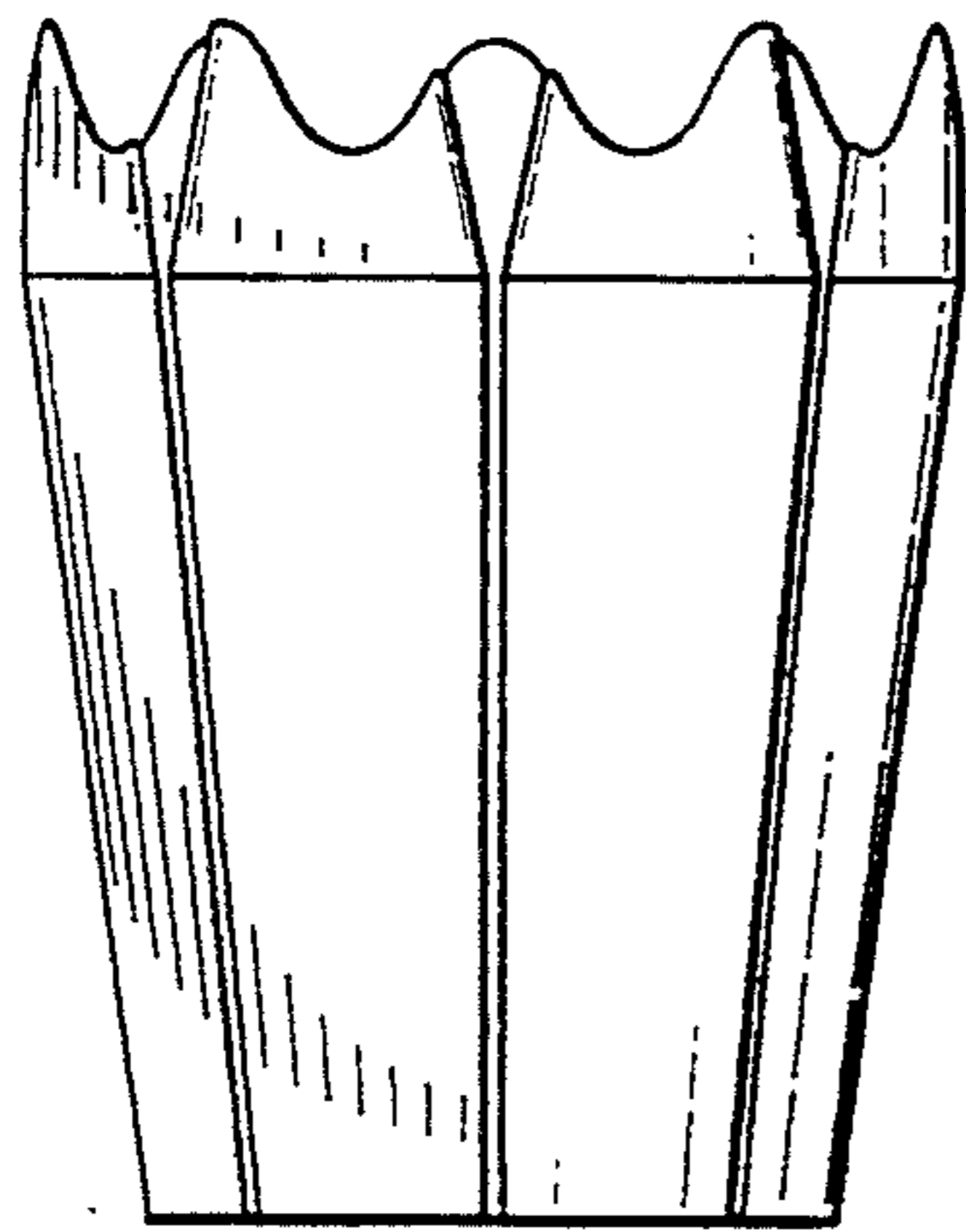

FIG. 9

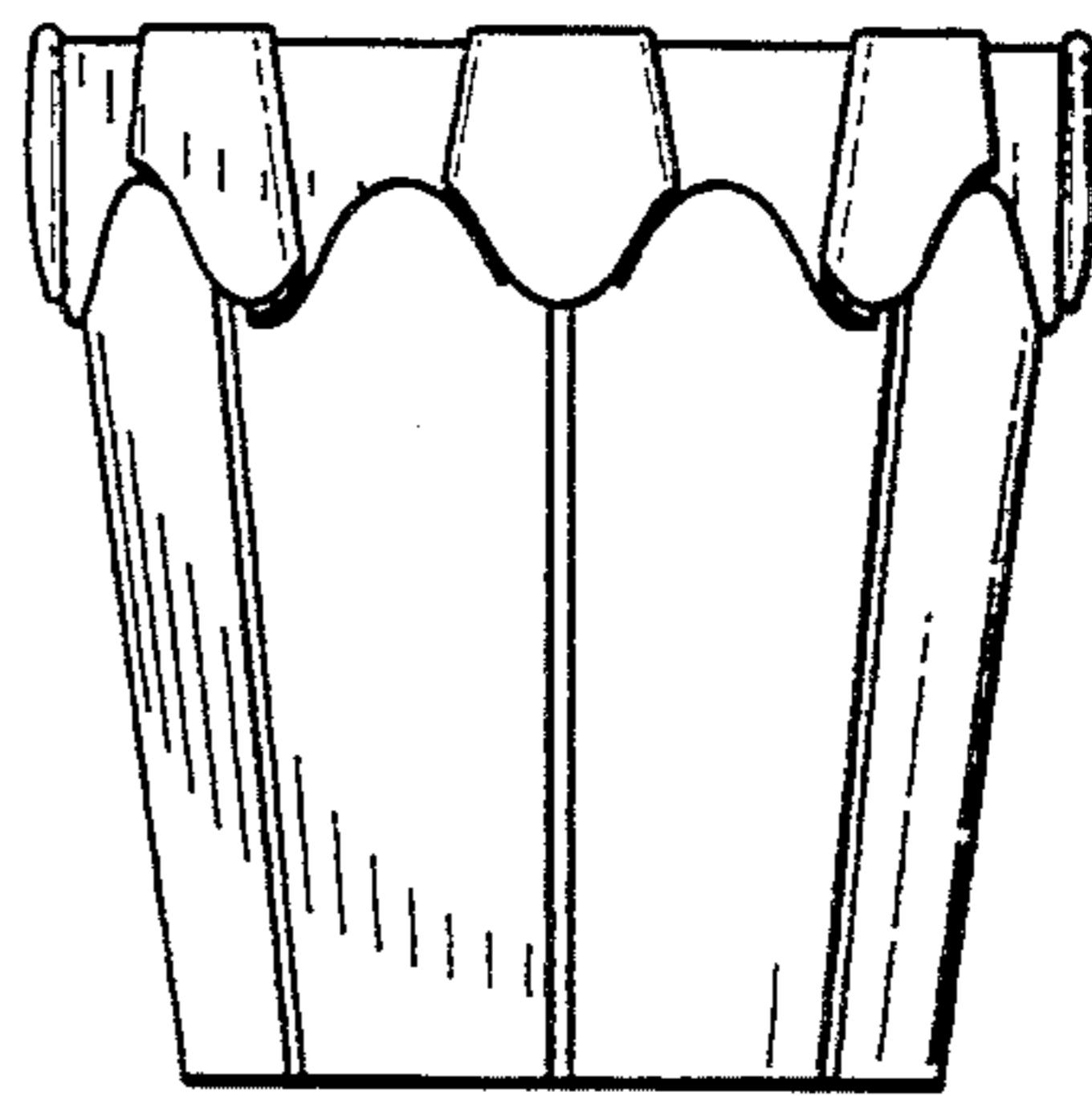

FIG. 10

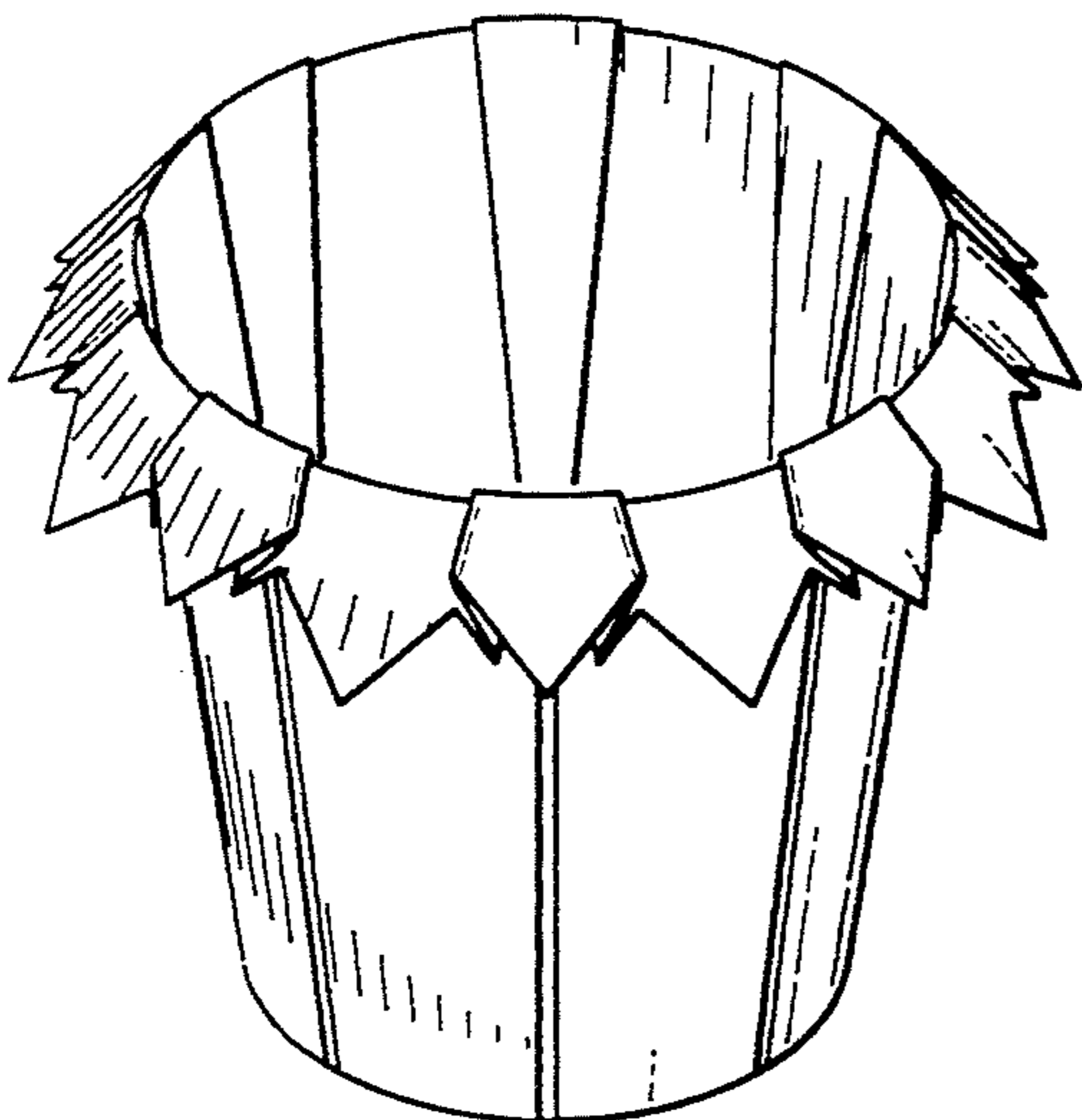

FIG. 11

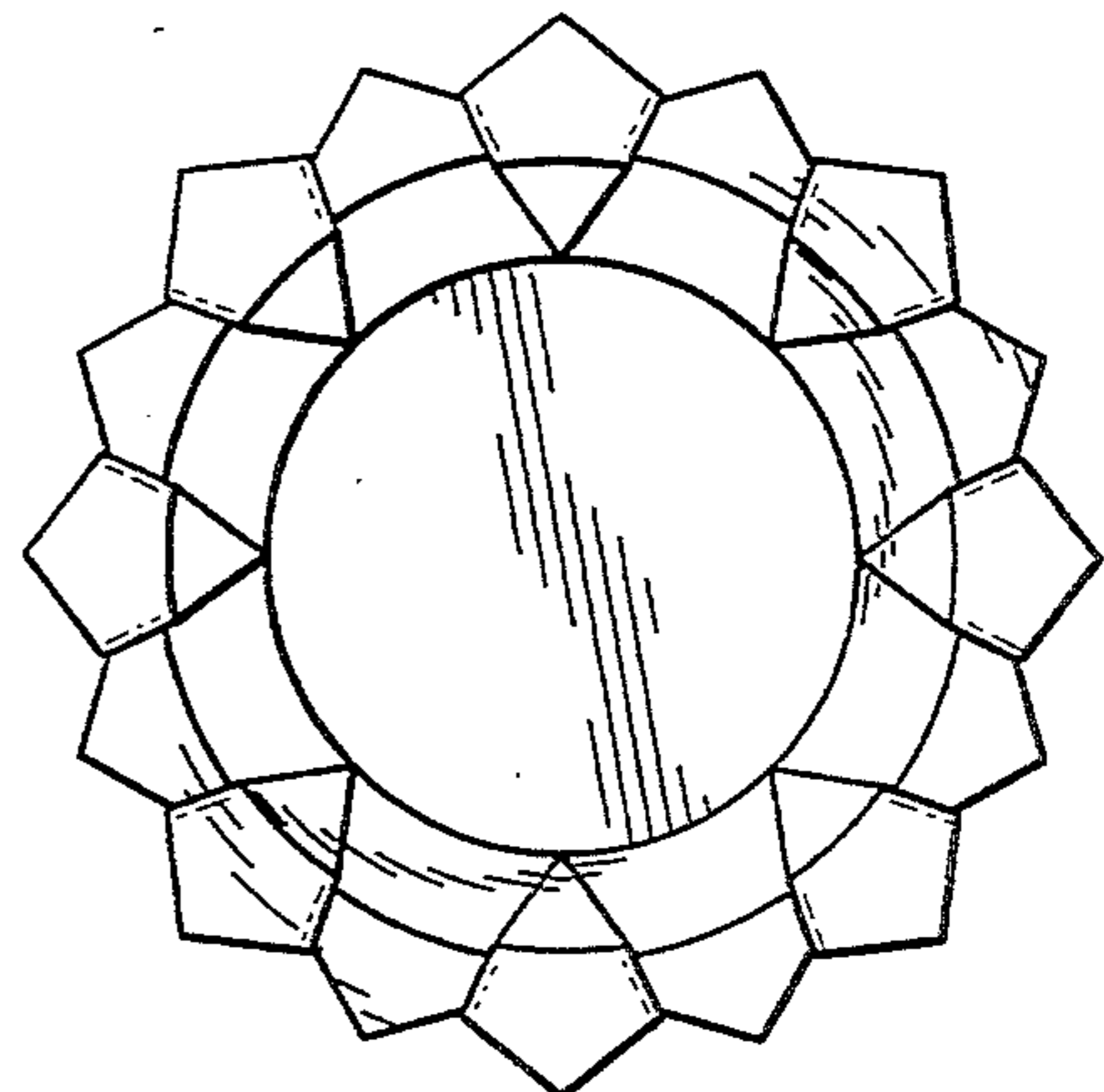

FIG. 12

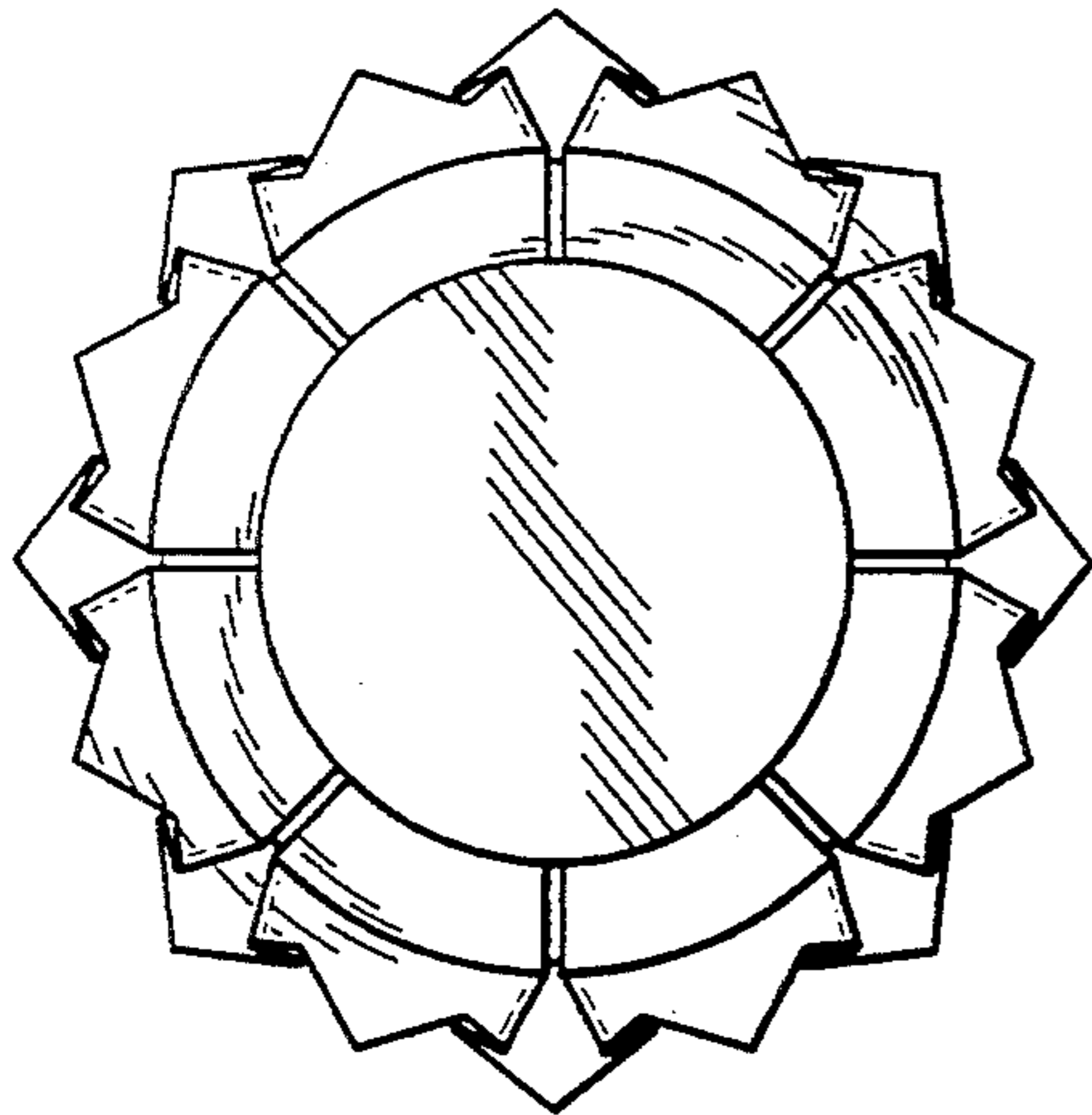

FIG. 13

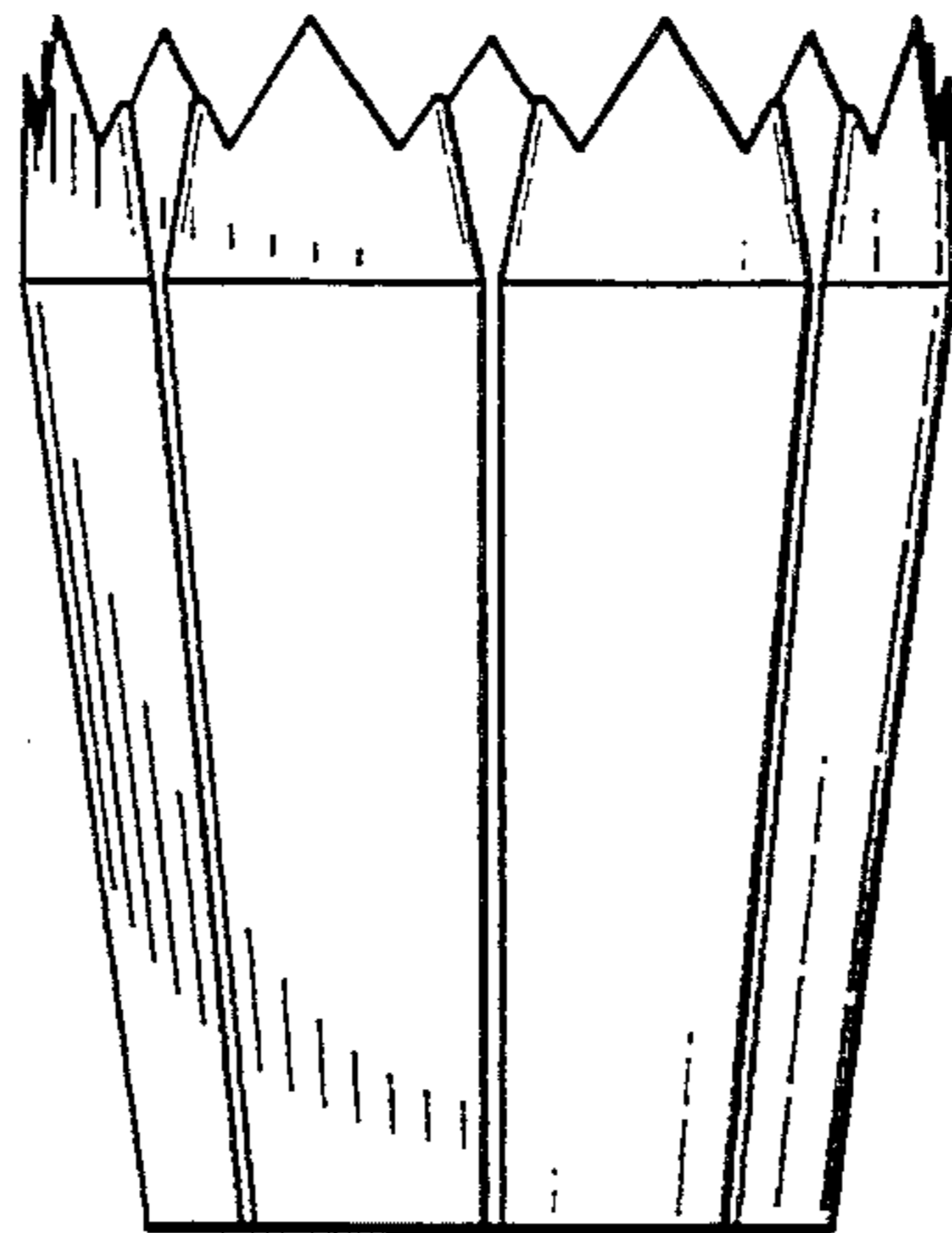

FIG. 14

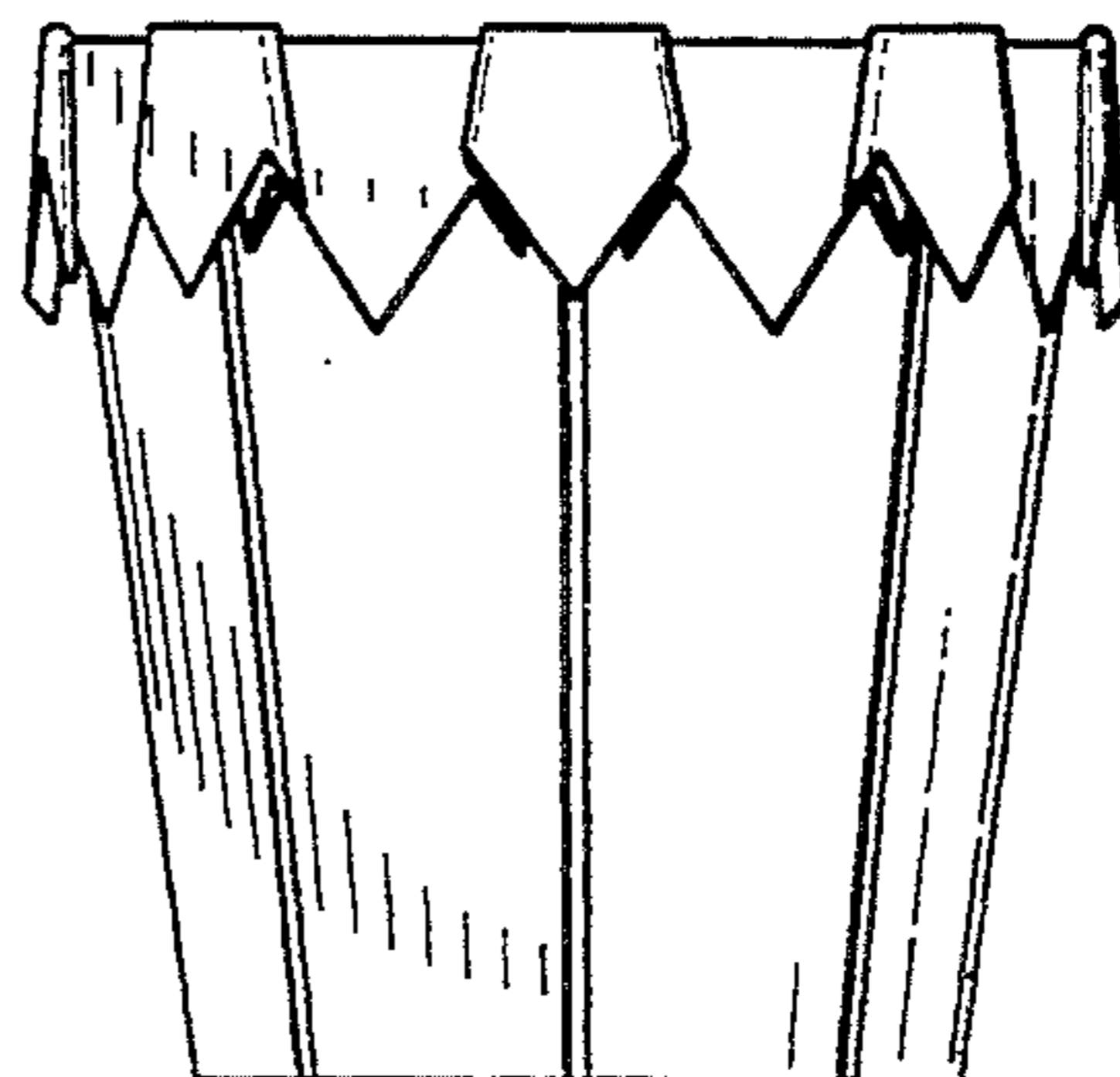

FIG. 15

UNITED STATES PATENT AND TRADEMARK OFFICE
CERTIFICATE OF CORRECTION

PATENT NO. : Des. 361,296
DATED : August 15, 1995
INVENTOR(S) : Weder, et. al.

It is certified that error appears in the above-identified patent and that said Letters Patent is hereby corrected as shown below:

Column 3, under U.S. PATENT DOCUMENTS, AFTER '3,022,605' delete "1/1962",
and substitute therefor --2/1962.--

Signed and Sealed this
Twelfth Day of December, 1995

Attest:



Attesting Officer

BRUCE LEHMAN

Commissioner of Patents and Trademarks