



US00D361249S

United States Patent [19]

[11] Patent Number: **Des. 361,249**

Bonte

[45] Date of Patent: **** Aug. 15, 1995**

[54] **STUD LOCATION MARKER**

4,372,049	2/1983	Hogue	33/36
4,669,905	6/1987	Hanna	33/36
4,993,159	2/1991	Hull et al.	33/41.3
5,195,247	3/1993	Wilcox	33/36

[76] Inventor: **Robert W. Bonte**, 6223 Shawnee Cir.,
Scotts, Mich. 49088

[**] Term: **14 Years**

Primary Examiner—Prabhakar G. Deshmukh
Assistant Examiner—Philip Hyder
Attorney, Agent, or Firm—Flynn, Thiel, Boutell & Tanis

[21] Appl. No.: **23,885**

[57] **CLAIM**

[22] Filed: **Jun. 2, 1994**

[52] U.S. Cl. **D8/51; D10/70**

The ornamental design for a stud location marker, as shown and described.

[58] Field of Search **D8/51, 14; D10/70;**
33/35, 36, 37, 41.3, 42

DESCRIPTION

[56] **References Cited**

U.S. PATENT DOCUMENTS

D. 214,756	7/1969	Kenworthy	D10/70
D. 233,785	11/1974	Evans, Jr.	D10/70
D. 234,098	1/1975	Coumbs	D10/70
D. 299,214	1/1989	Kimura	D10/70
2,451,595	10/1948	Wheeler	33/41.3
3,546,779	12/1970	Klein	33/36

FIG. 1 is a top and left end isometric view of a stud location marker embodying my new design;
FIG. 2 is a rear view thereof;
FIG. 3 is a left side view thereof;
FIG. 4 is a right side view thereof;
FIG. 5 is a front view thereof;
FIG. 6 is a bottom view thereof; and;
FIG. 7 is a top view thereof.

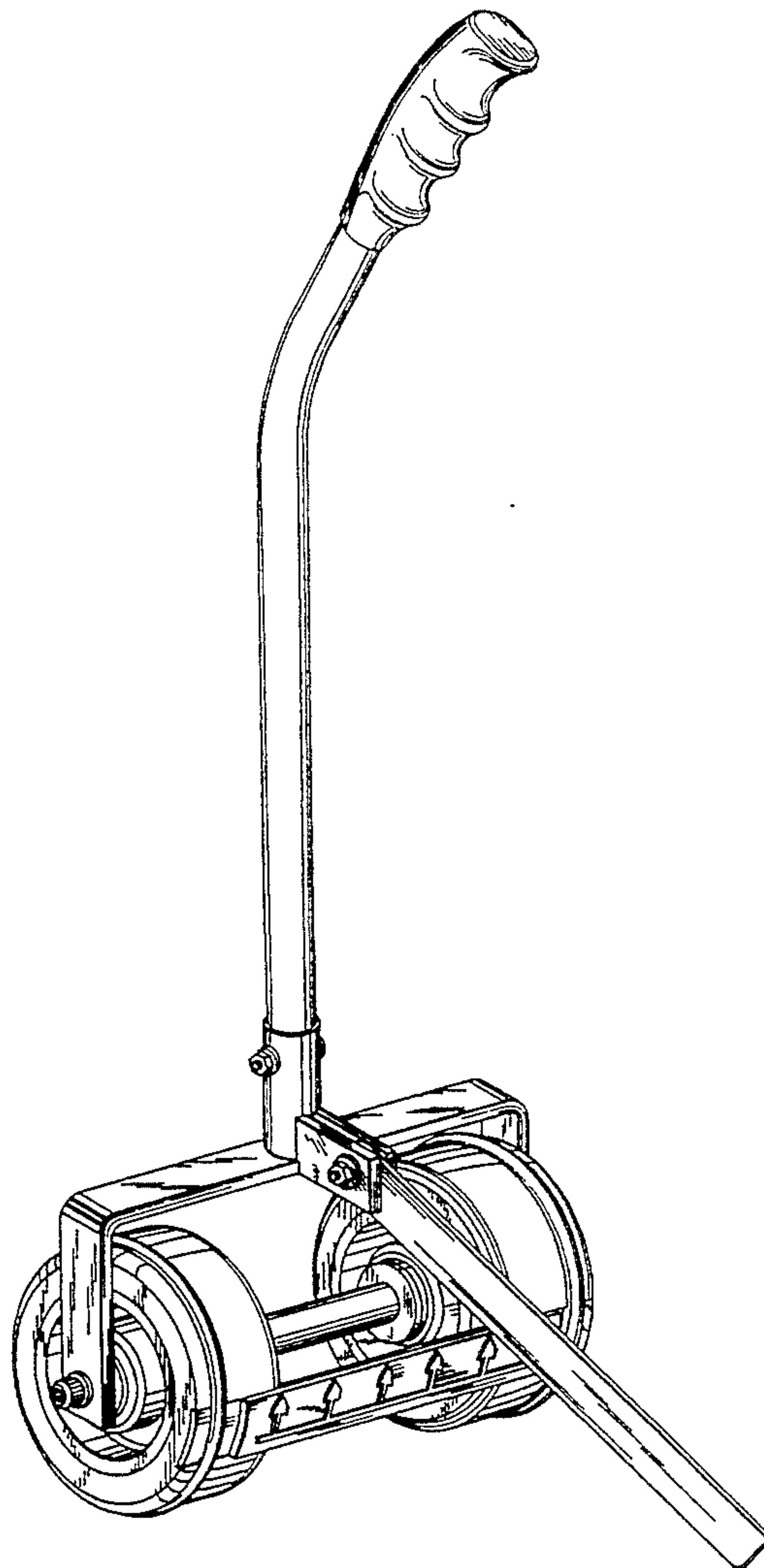

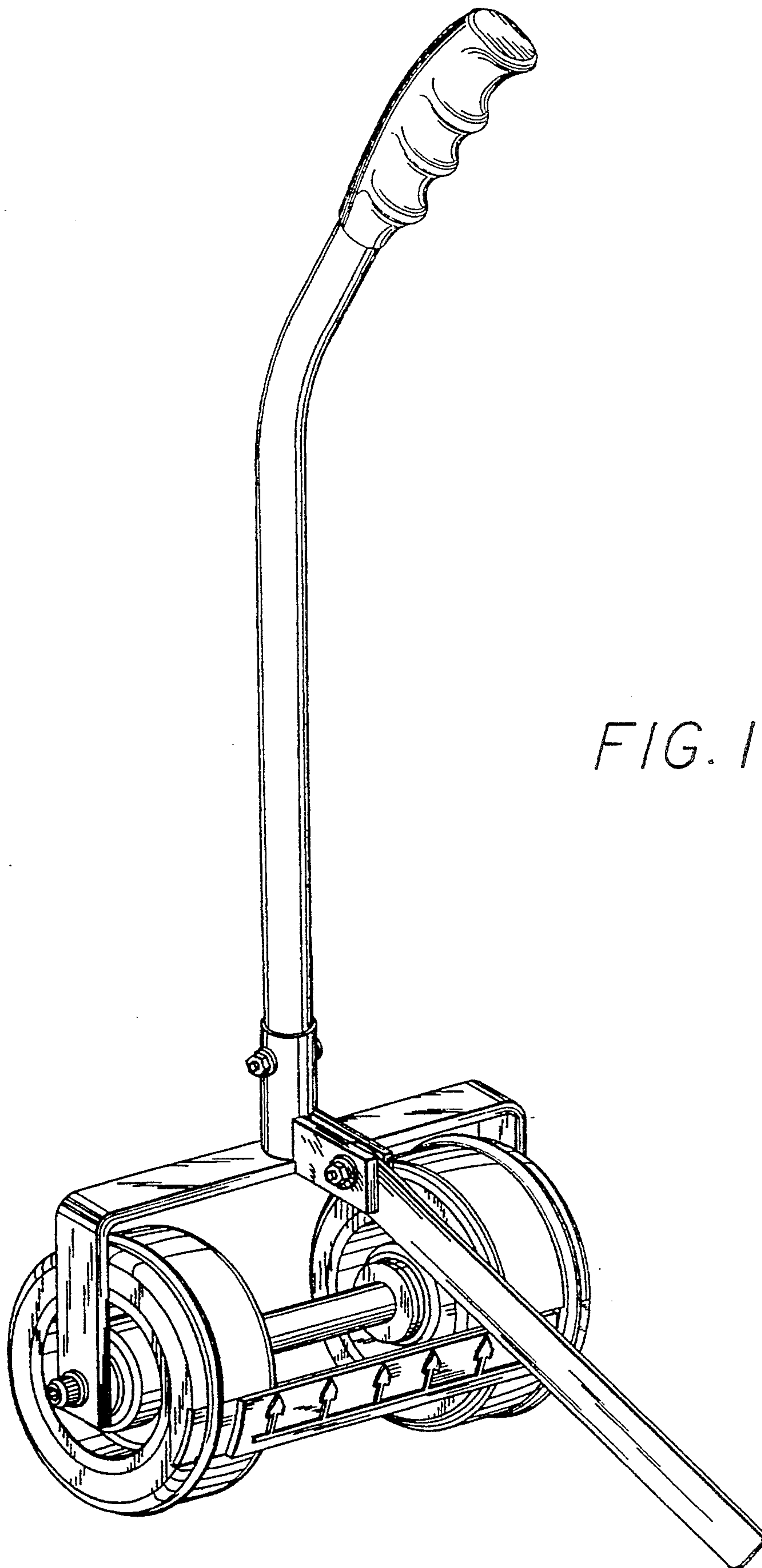

FIG. 1

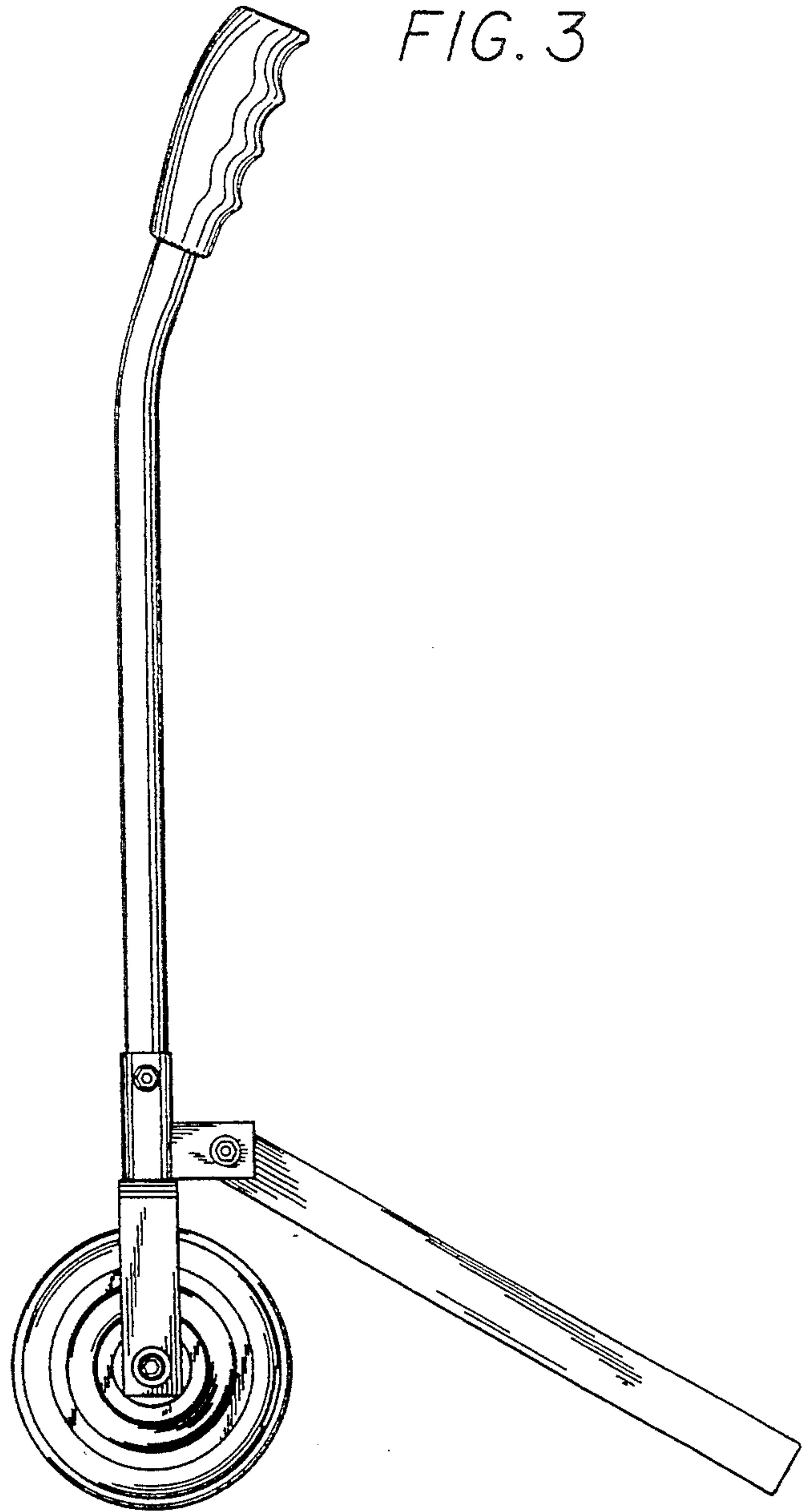
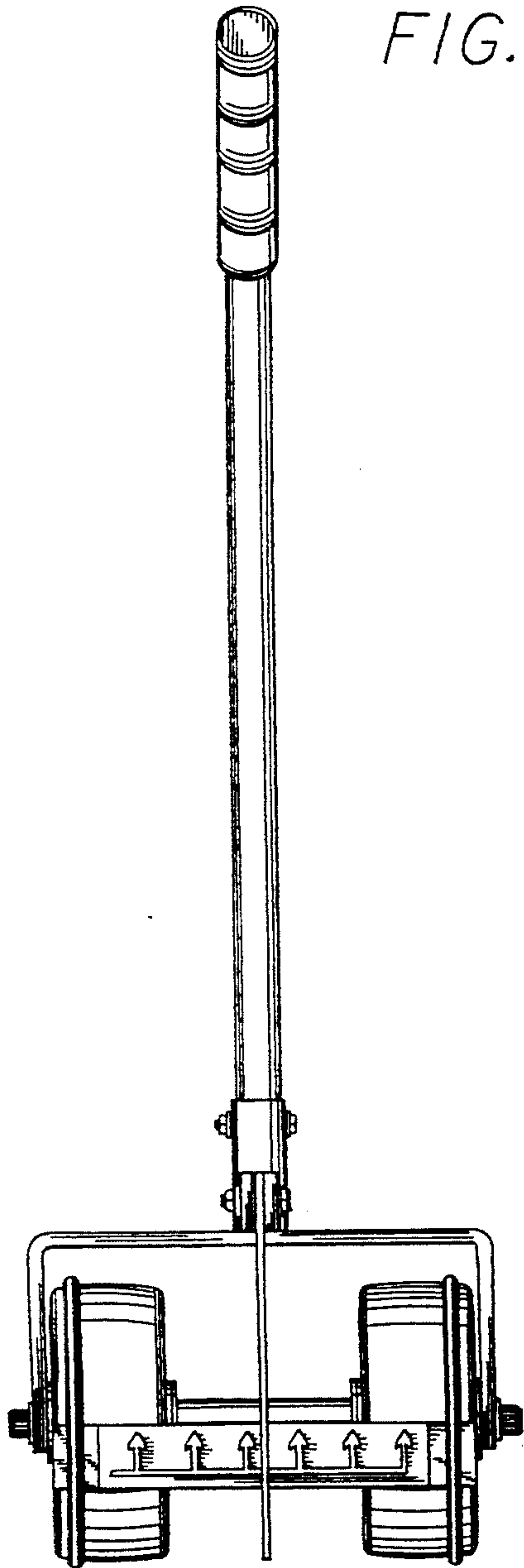

FIG. 4

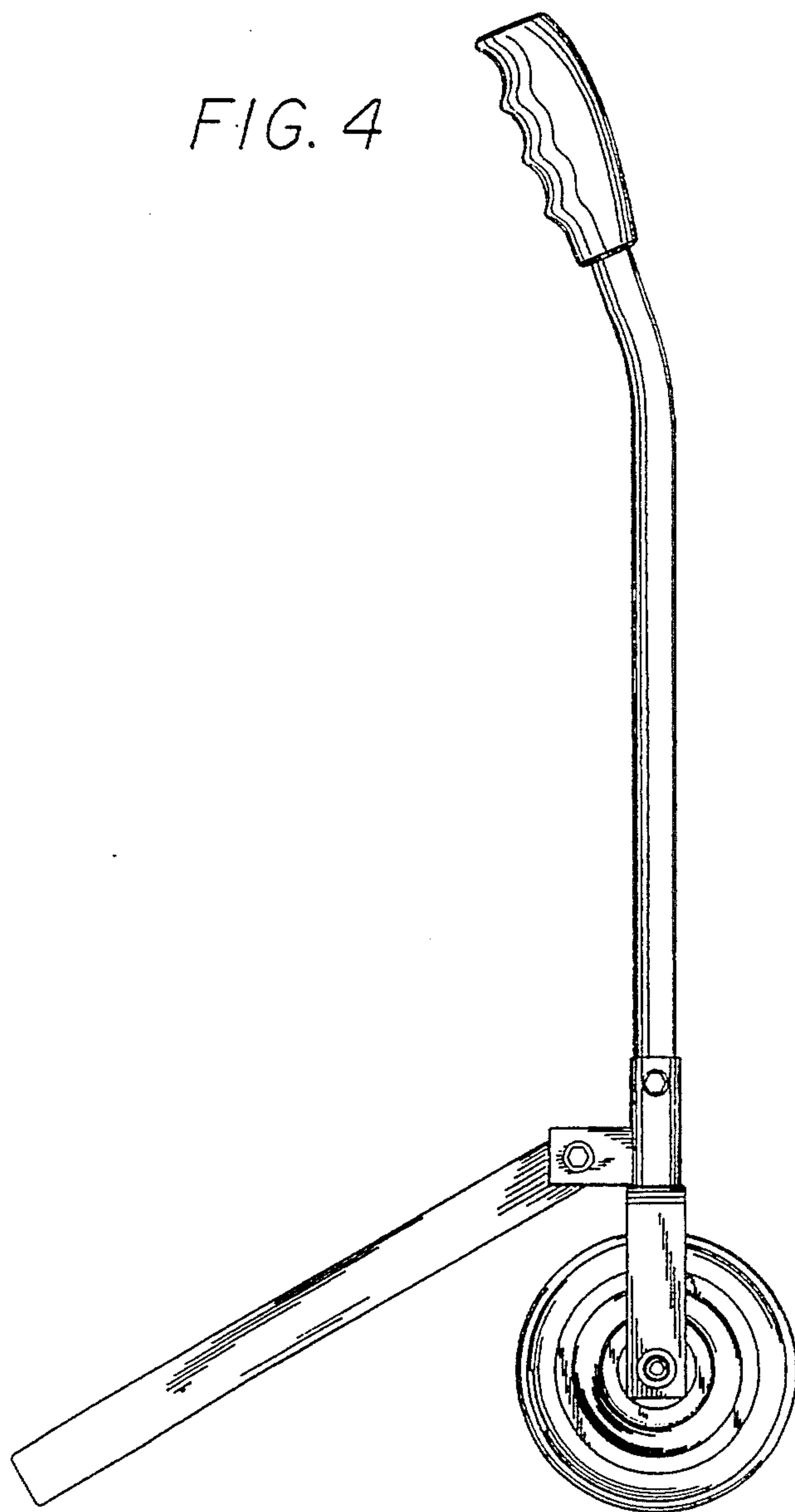

FIG. 5

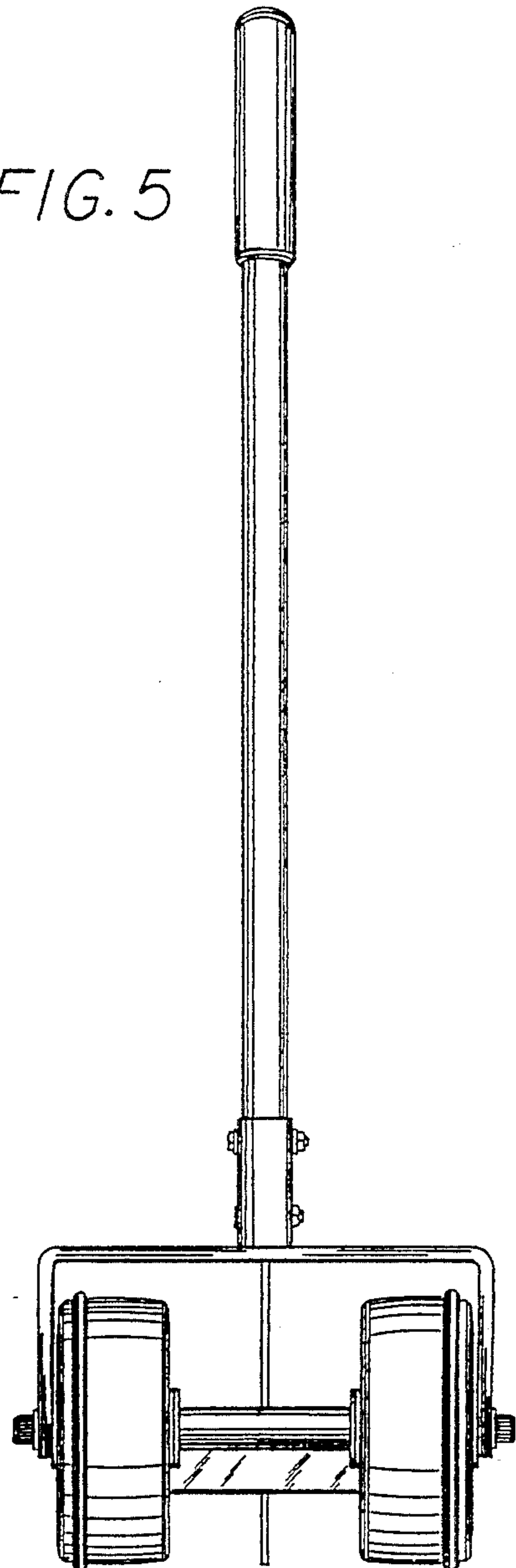

FIG. 6

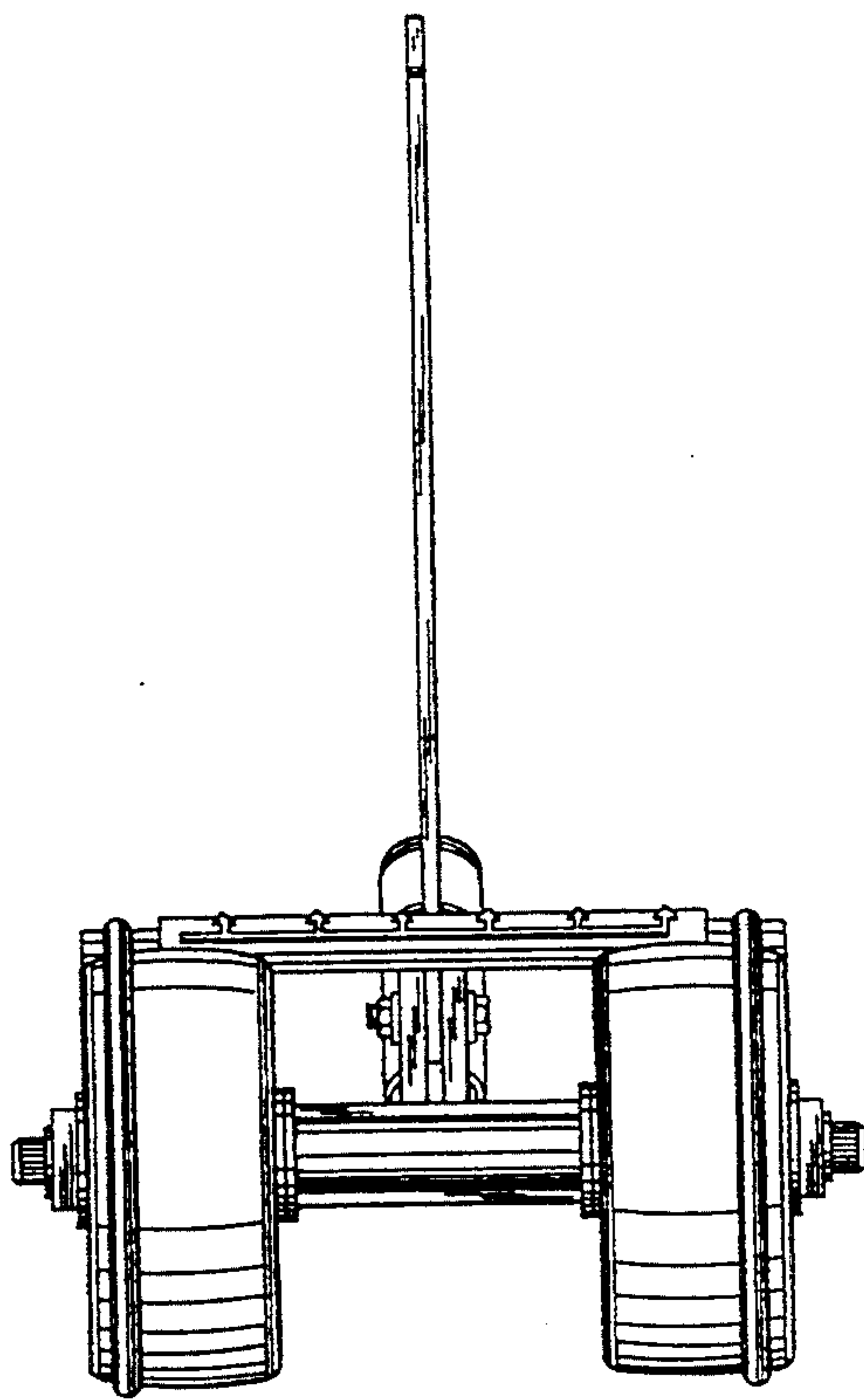

FIG. 7

