



US00D361219S

United States Patent [19]

[11] Patent Number: Des. 361,219

Luymes

[45] Date of Patent: ** Aug. 15, 1995

[54] FISHING ROD CAROUSEL

[76] Inventor: Kirk M. Luymes, P.O. Box 10, Wessington Springs, S. Dak. 57382-2042

[**] Term: 14 Years

[21] Appl. No.: 9,018

[22] Filed: Jul. 2, 1993

[52] U.S. Cl. D6/432; D6/407

[58] Field of Search D6/396, 397, 400, 432-438, D6/552, 455; D3/260; D22/147, 148; 211/60.1, 64, 70.8

970,046 9/1910 Hampton .
1,478,043 7/1921 Matteson .
4,628,628 12/1986 Burgin et al. .
5,064,077 11/1991 Mitchell 211/60.1
5,137,319 8/1992 Sauder 211/70.8 X

Primary Examiner—Alan P. Douglas
Assistant Examiner—Cathron B. Matta
Attorney, Agent, or Firm—Richard C. Litman

[57] CLAIM

The ornamental design for a fishing rod carousel, as shown and described.

DESCRIPTION

FIG. 1 is a left hand perspective view of a fishing rod carousel with the door open, showing my new design; FIG. 2 is a right hand perspective view thereof with the door closed; FIG. 3 is a front elevational view of FIG. 1; FIG. 4 is a top plan view of FIG. 1; FIG. 5 is a bottom view of FIG. 1; FIG. 6 is a right side elevational view of FIG. 2; FIG. 7 is a left side elevational view of FIG. 2; and, FIG. 8 is a rear view of FIG. 2. The broken line showing of the shelves in FIGS. 1 and 3, and the indicia in FIG. 2 and the fishing rod in FIG. 3 is for illustrative purposes only and forms no part of the claimed design.

[56] References Cited

U.S. PATENT DOCUMENTS

D. 37,304	1/1905	Palmer	D6/455
D. 103,680	3/1937	Hardy	D6/397
D. 154,103	6/1949	Desky	.	
D. 154,105	6/1949	Desky	.	
D. 155,705	10/1949	Hobbs	211/60.1 X
D. 241,899	10/1976	Kingsford	D6/436
D. 272,787	2/1984	Rembaugh	D6/552
D. 329,153	9/1992	Kijanka et al.	211/60.1 X
405,335	6/1889	Amerine	.	
816,959	4/1906	Briganti	211/60.1
830,843	9/1906	Monaghan	.	

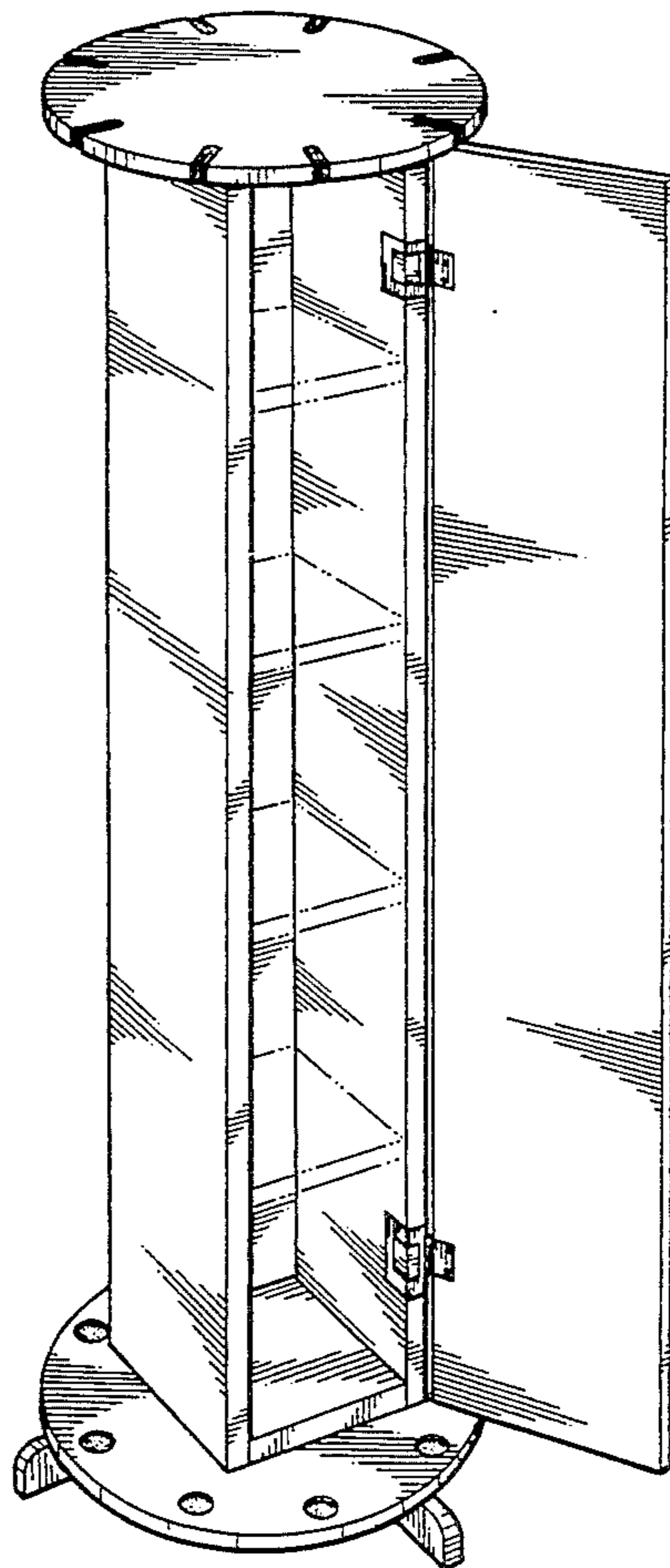

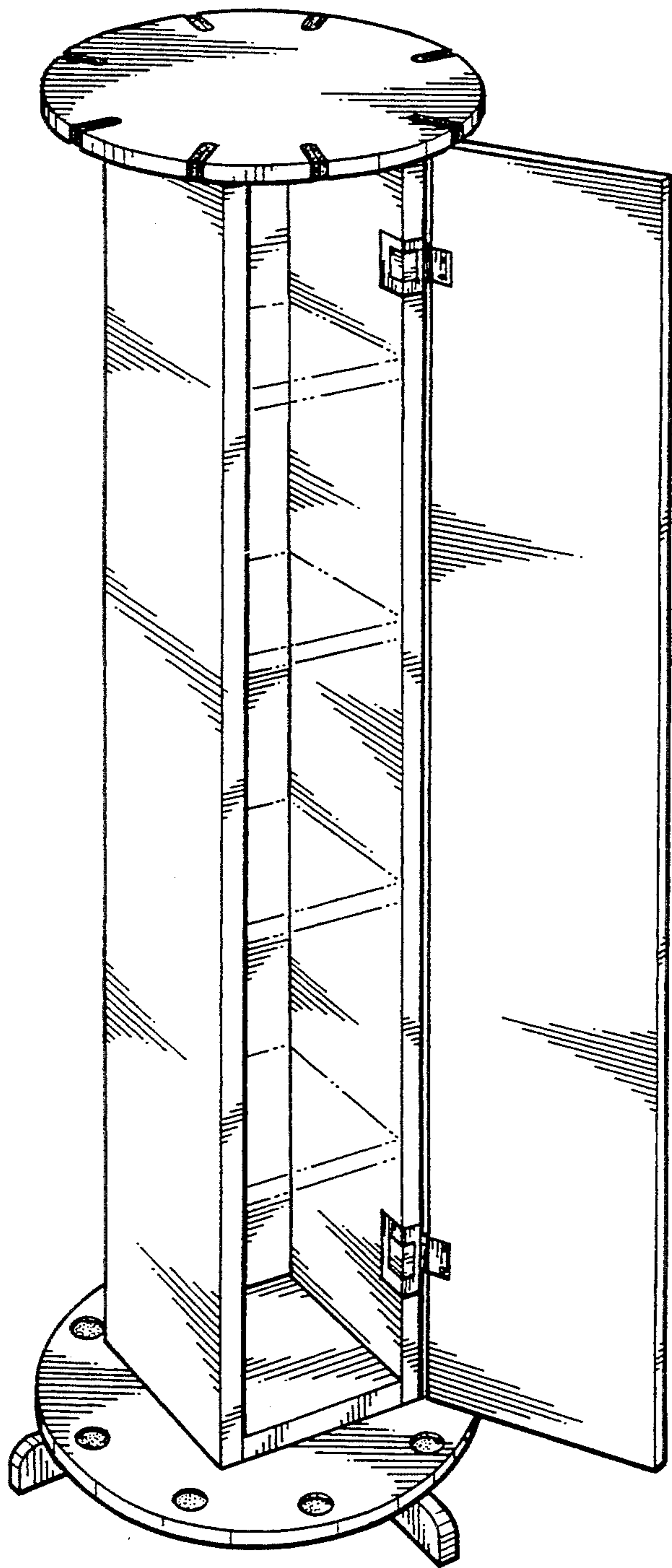

FIG. 1

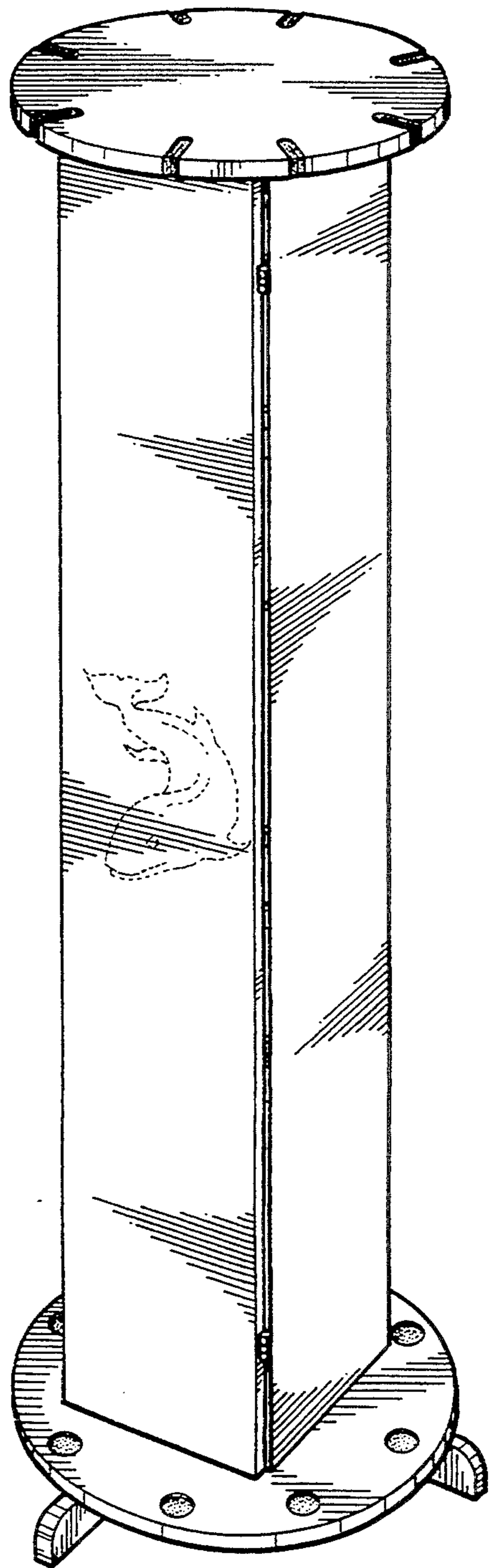

FIG. 2

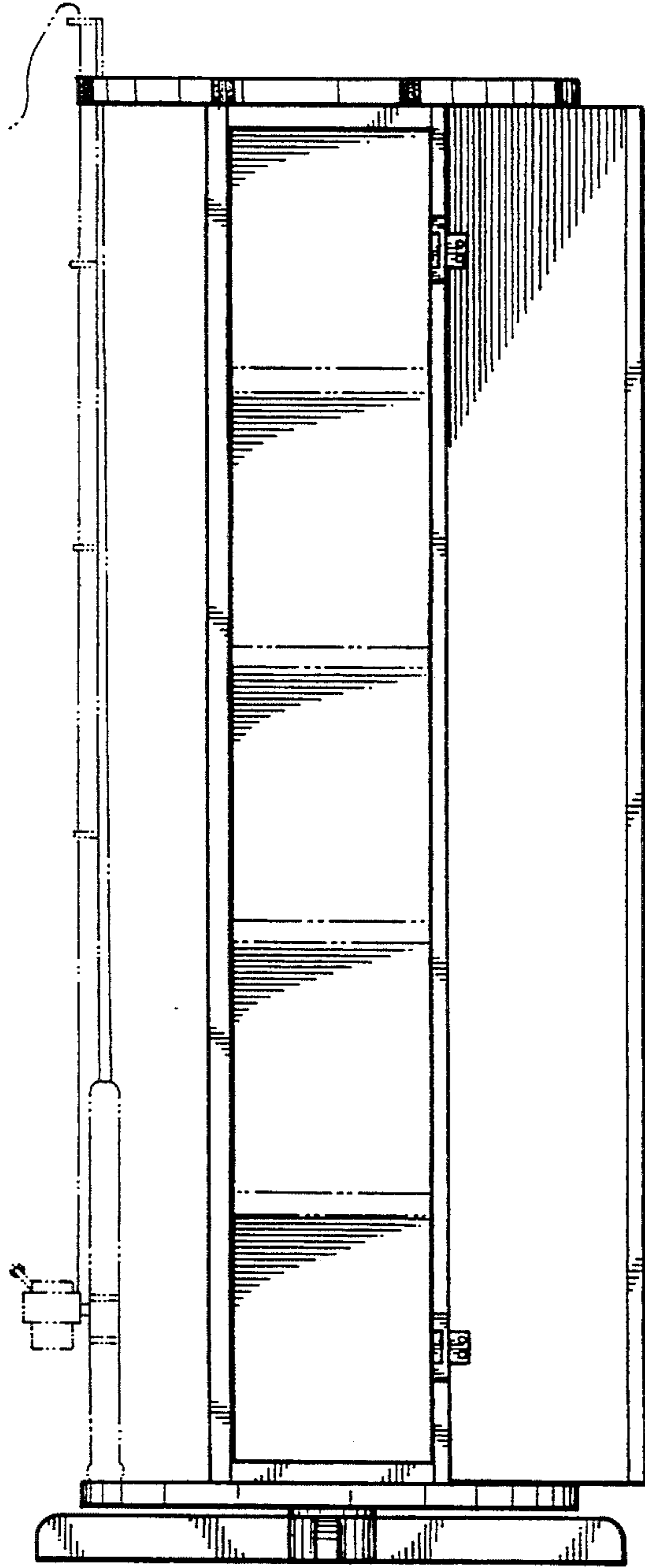

FIG. 3

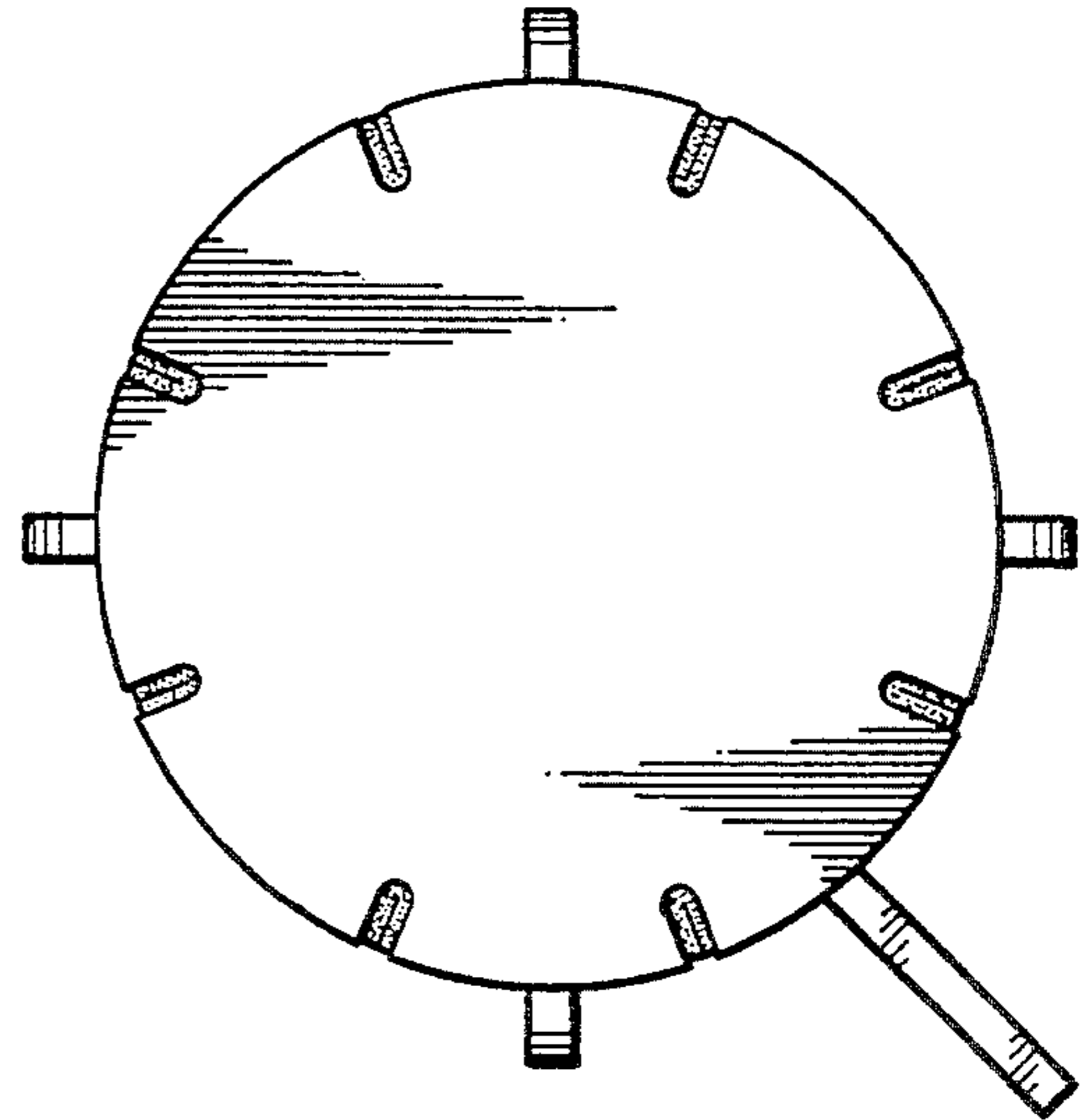

FIG. 4

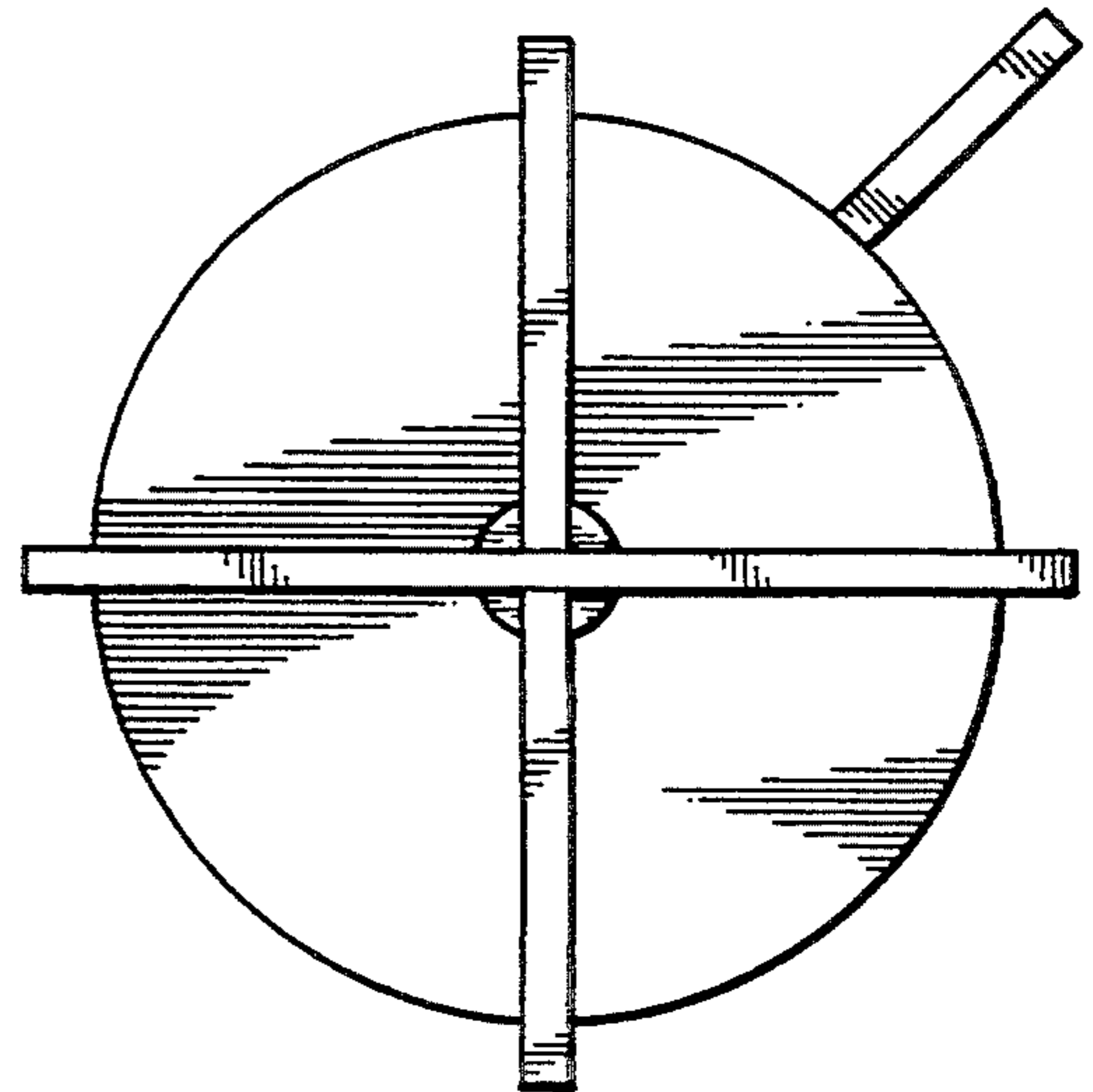

FIG. 5

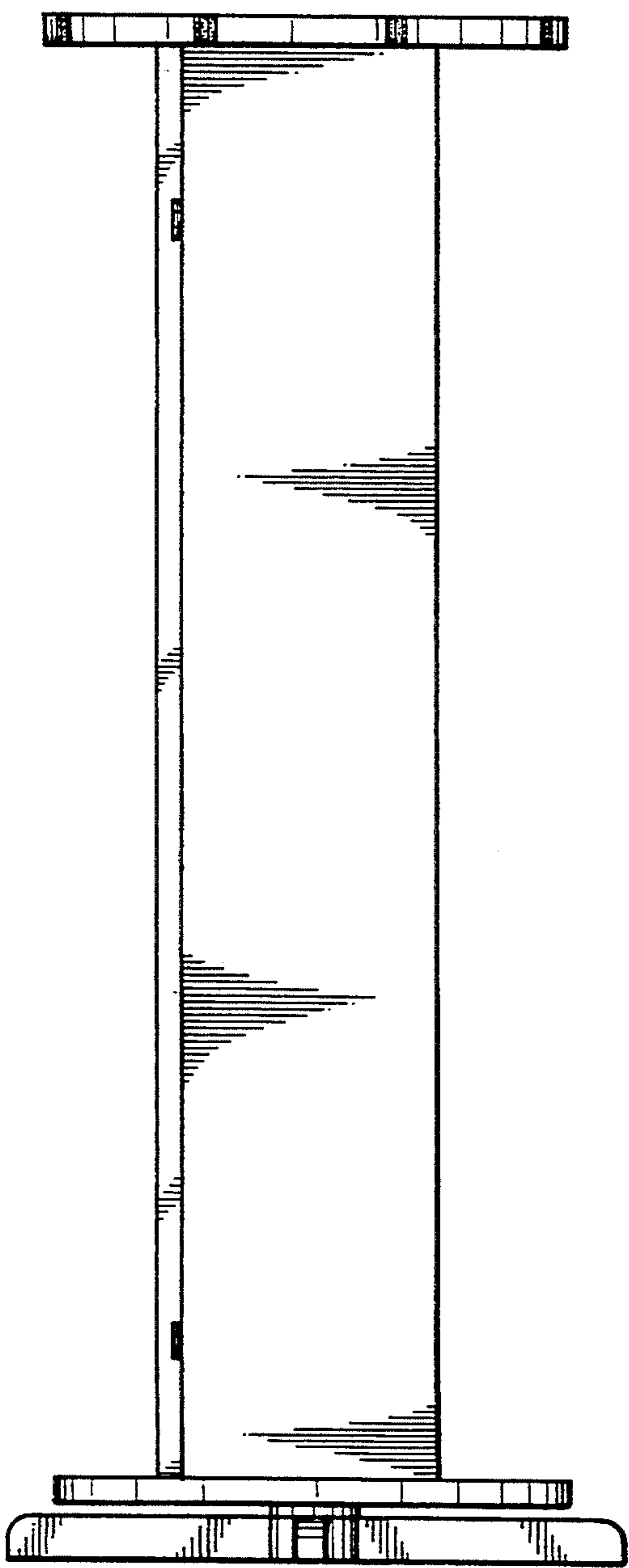

FIG. 6

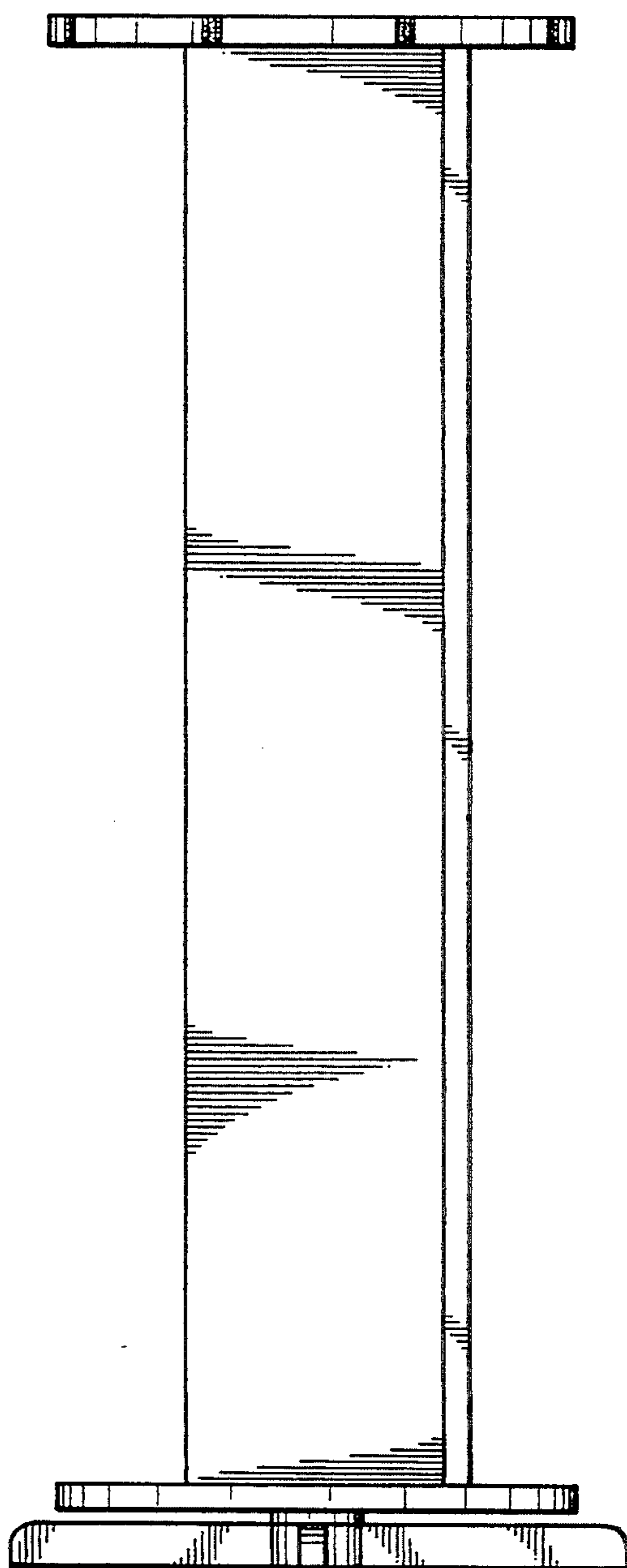

FIG. 7

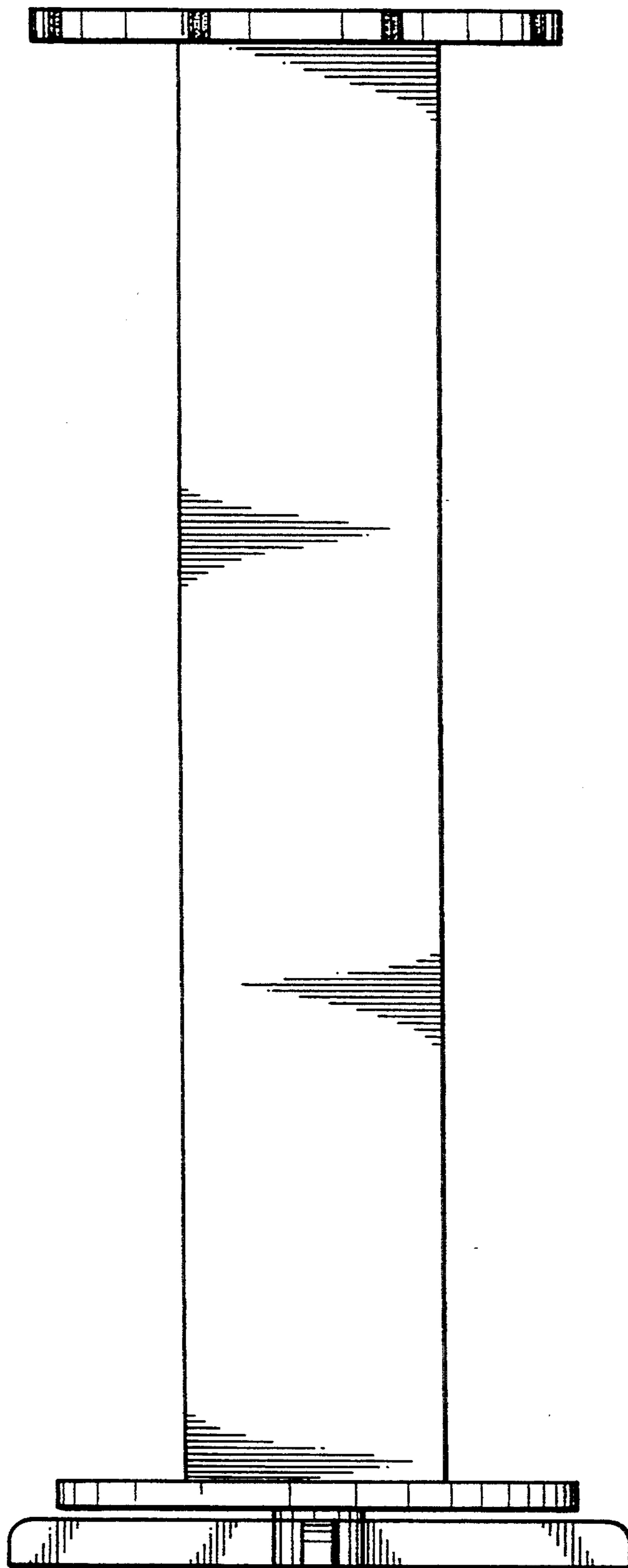

FIG. 8