



US00D361194S

# United States Patent [19]

[11] Patent Number: **Des. 361,194**

Grosswiller et al.

[45] Date of Patent: **\*\* Aug. 8, 1995**

[54] **TERMINAL FOR PNEUMATIC TUBE SYSTEM**

[75] Inventors: **Leo J. Grosswiller**, East Canton;  
**Walter G. Anders**; **Robert J. Beck**,  
both of North Canton, all of Ohio

[73] Assignee: **Diebold, Incorporated**, Canton, Ohio

[\*] Notice: The portion of the term of this patent subsequent to Nov. 2, 2007 has been disclaimed.

[\*\*] Term: **14 Years**

[21] Appl. No.: **9,219**

[22] Filed: **Jun. 9, 1993**

[52] U.S. Cl. .... **D99/35**

[58] Field of Search ..... **D99/35, 28; D18/35; 406/112, 27; D34/28; 232/1 D, 1 R; 243/19**

[56] **References Cited**

**U.S. PATENT DOCUMENTS**

D. 267,127	11/1982	Noel	.....	D99/35
D. 272,076	1/1984	Greene	.	
D. 272,291	1/1984	Hauser et al.	.....	D99/28
D. 291,379	8/1987	Gengler et al.	.....	D99/28
D. 330,105	10/1992	Schnitz, Jr.	.	
D. 341,014	11/1993	Grosswiller et al.	.....	D99/28
3,189,297	6/1965	Ellithorpe	.	
3,572,223	3/1971	Vierregger	.	
3,610,554	10/1971	Schwarz et al.	.	
3,612,438	10/1971	Herndon	.	
3,738,592	6/1973	Smith et al.	.	

3,756,536	9/1973	Weissmuller	.
3,790,102	2/1974	Tearne et al.	.
3,841,584	10/1974	Robinson et al.	.
4,032,082	6/1977	Weissmuller	.
4,352,603	10/1982	Anders	.
4,913,598	4/1990	Dozier	.
4,929,021	5/1990	Kaye	.

*Primary Examiner*—Alan P. Douglas  
*Assistant Examiner*—J. H. Musgrove  
*Attorney, Agent, or Firm*—D. Peter Hochberg; Mark Kusner; Michael Jaffe

[57] **CLAIM**

The ornamental design for a terminal for pneumatic tube system, as shown and described.

**DESCRIPTION**

FIG. 1 is a perspective view of a terminal for pneumatic tube system showing my new design;  
FIG. 2 is a front view;  
FIG. 3 is a left-side view;  
FIG. 4 is a right side view;  
FIG. 5 is a top view;  
FIG. 6 is a bottom view;  
FIG. 7 is a rear view;  
FIG. 8 is a perspective view of my second embodiment;  
FIG. 9 is a front view;  
FIG. 10 is a left side view;  
FIG. 11 is a right side view;  
FIG. 12 is a top view;  
FIG. 13 is a bottom view; and,  
FIG. 14 is a rear view thereof.

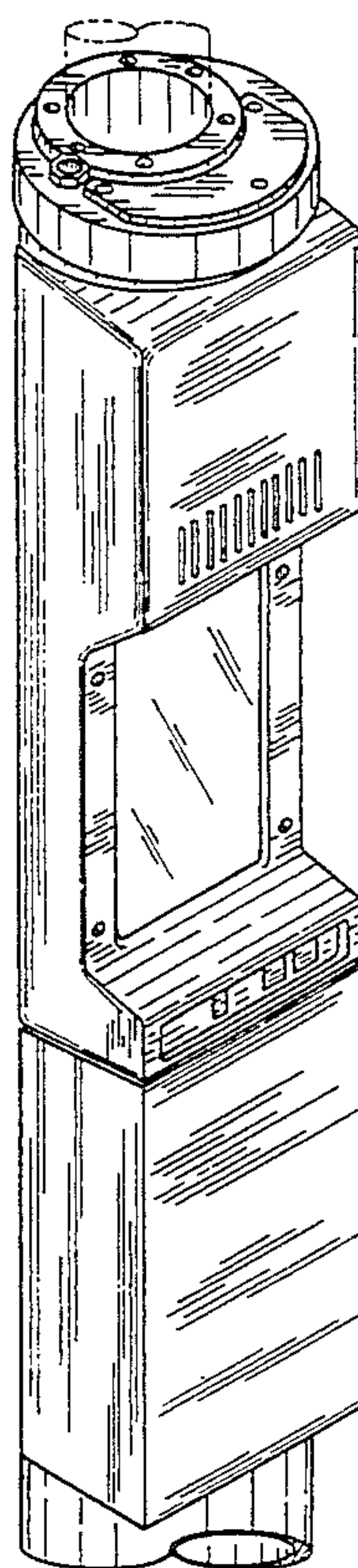

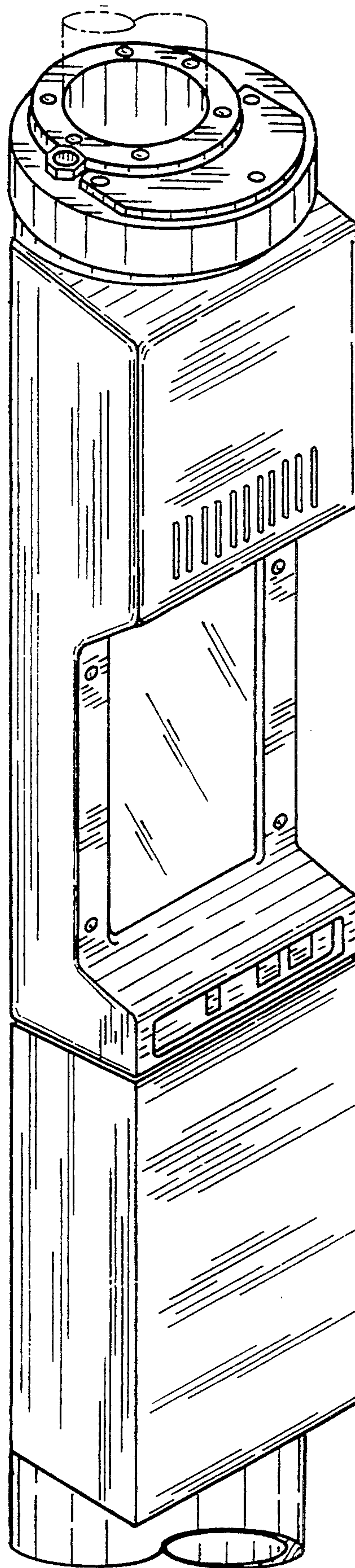

FIG. 1

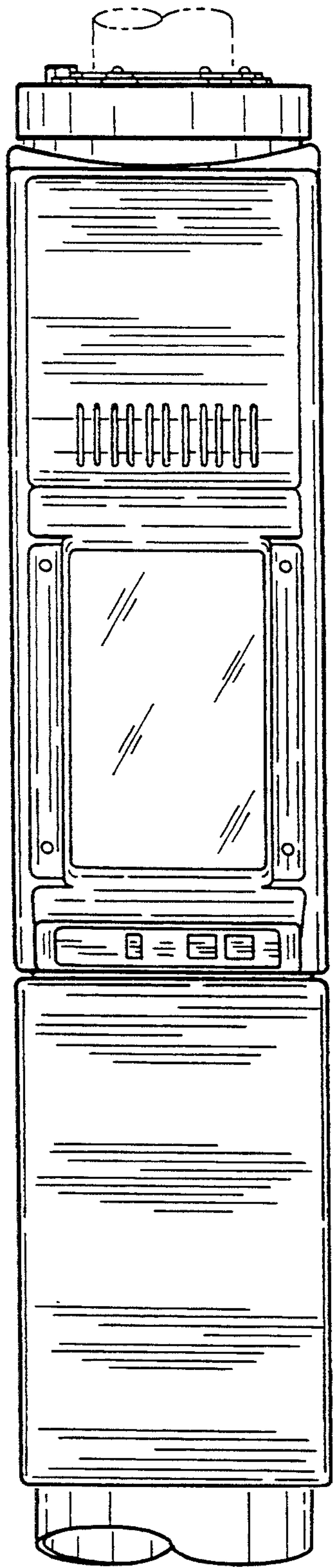

FIG. 2

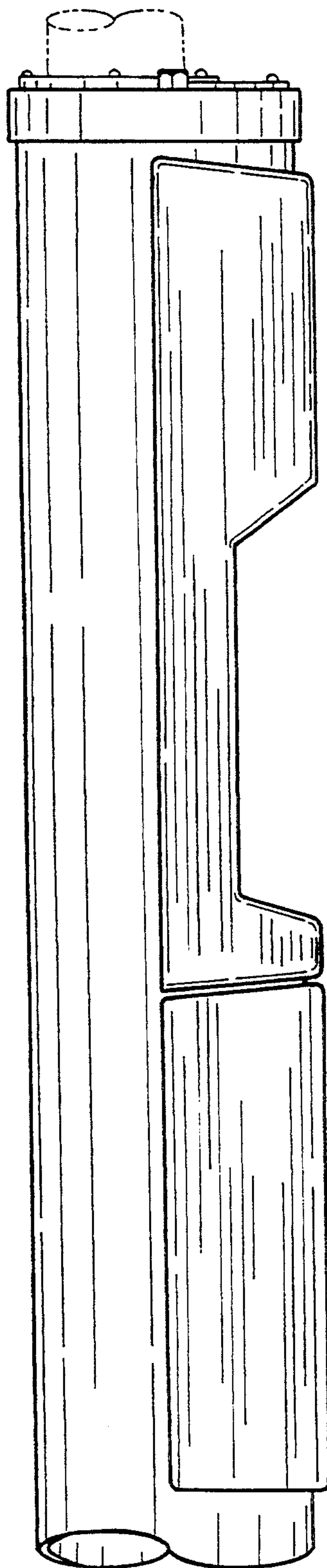

FIG. 3

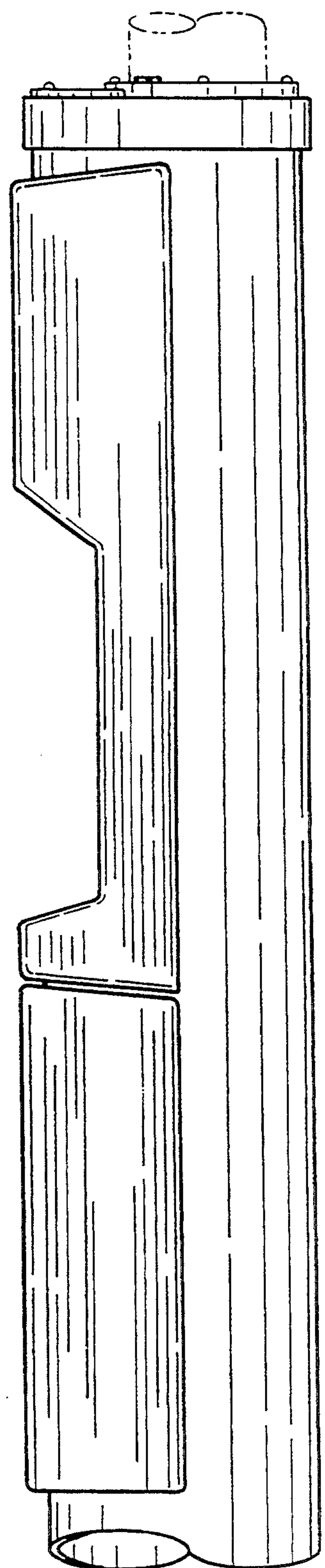

FIG. 4



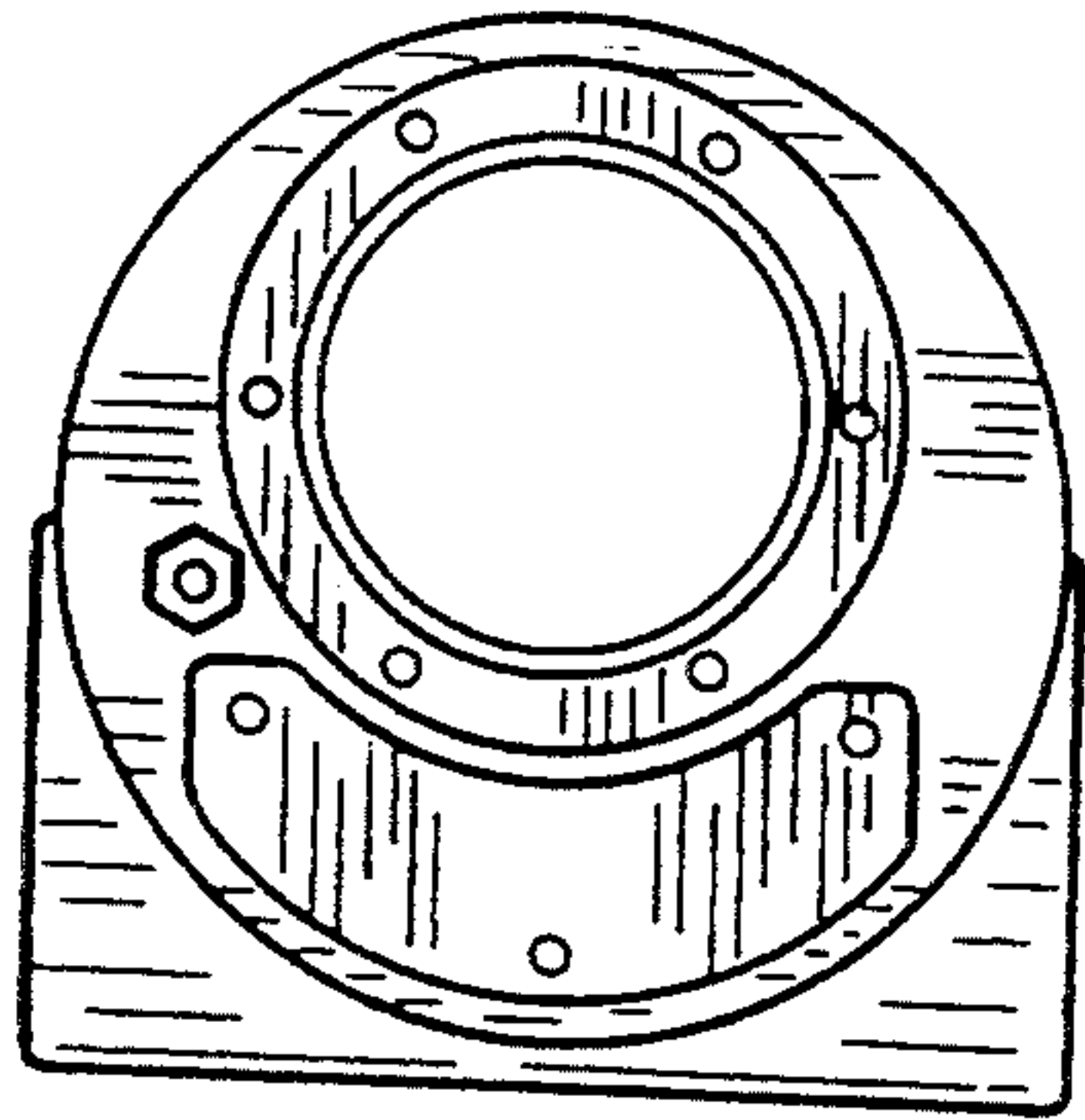

FIG. 5

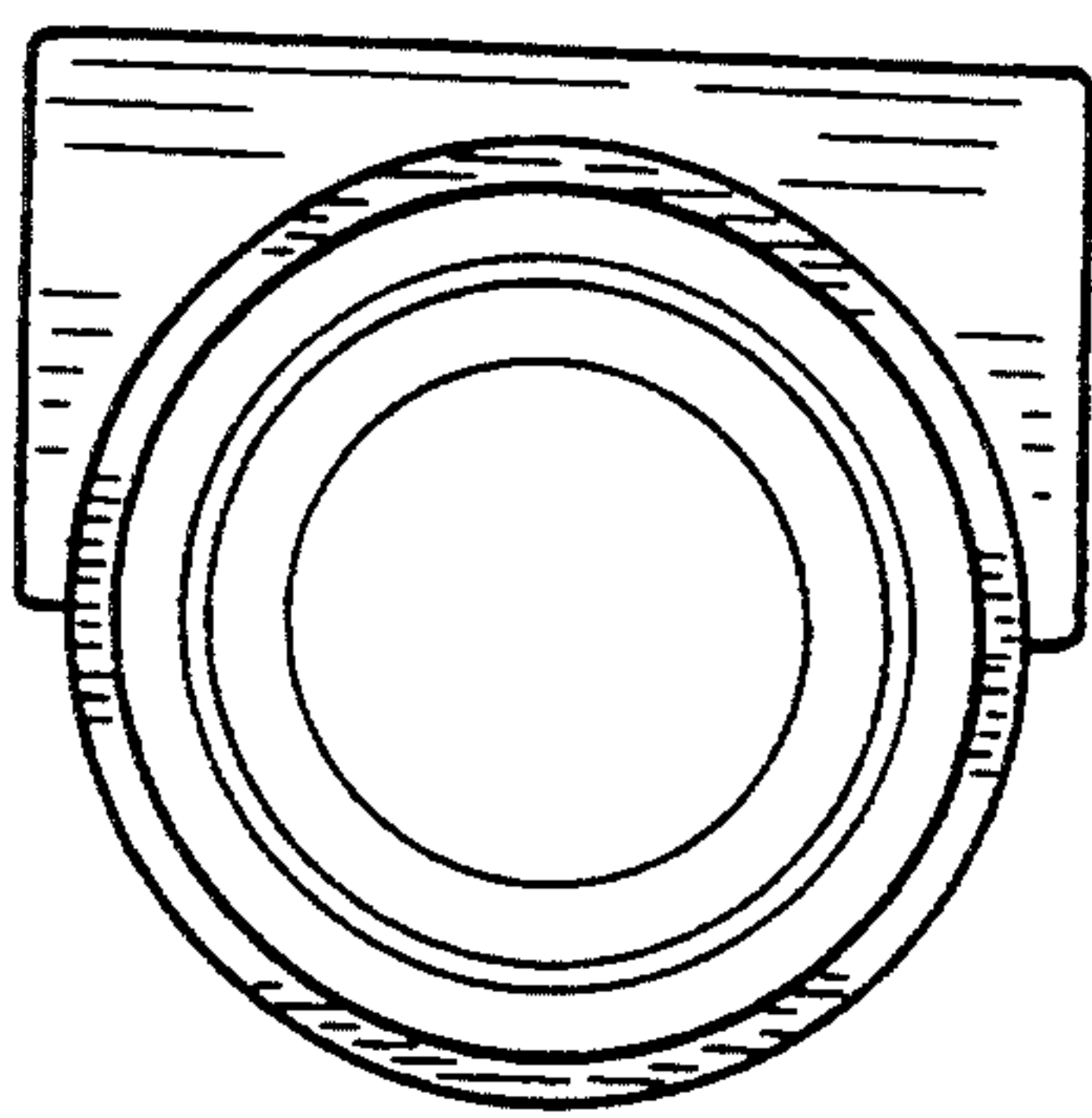

FIG. 6

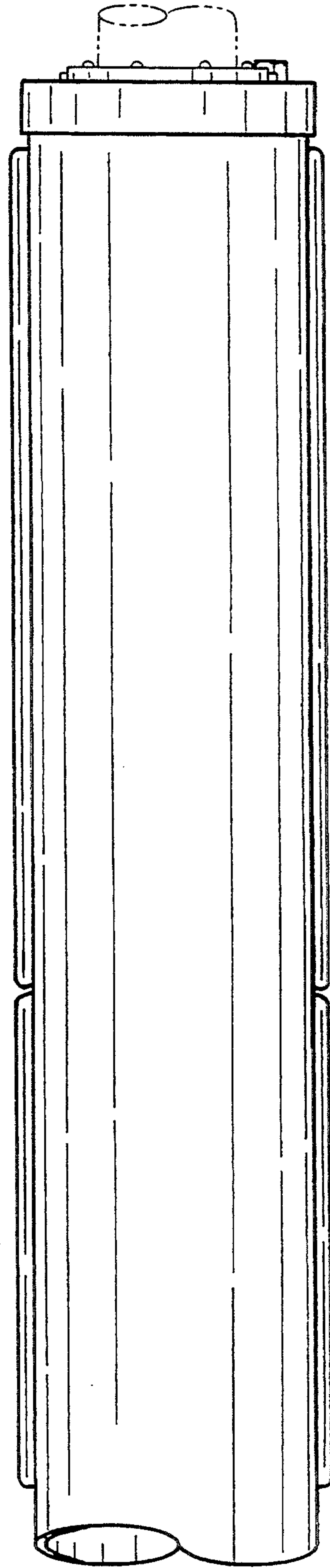

FIG. 7

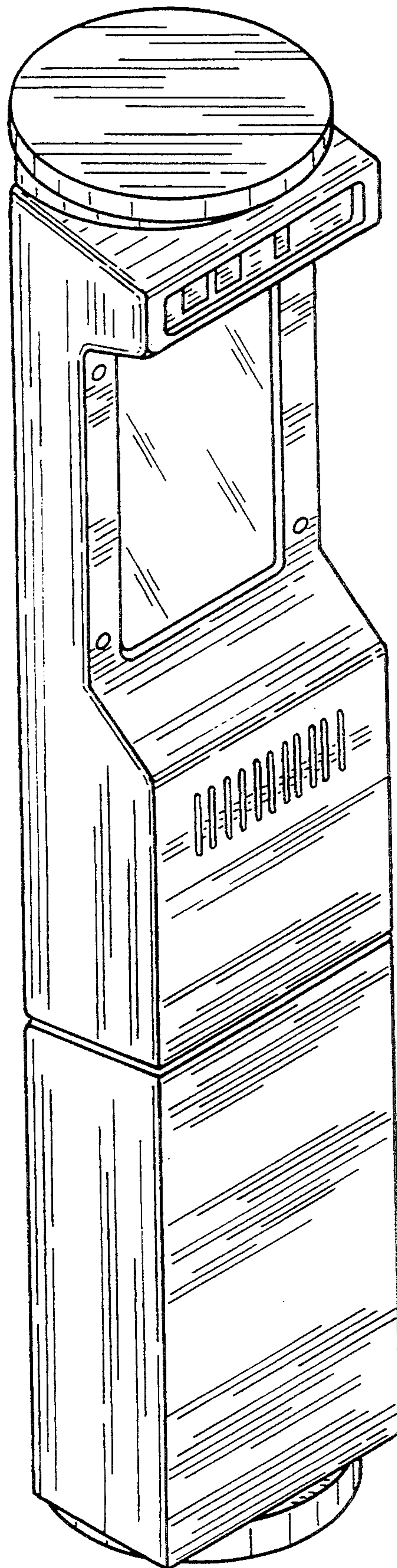

FIG. 8

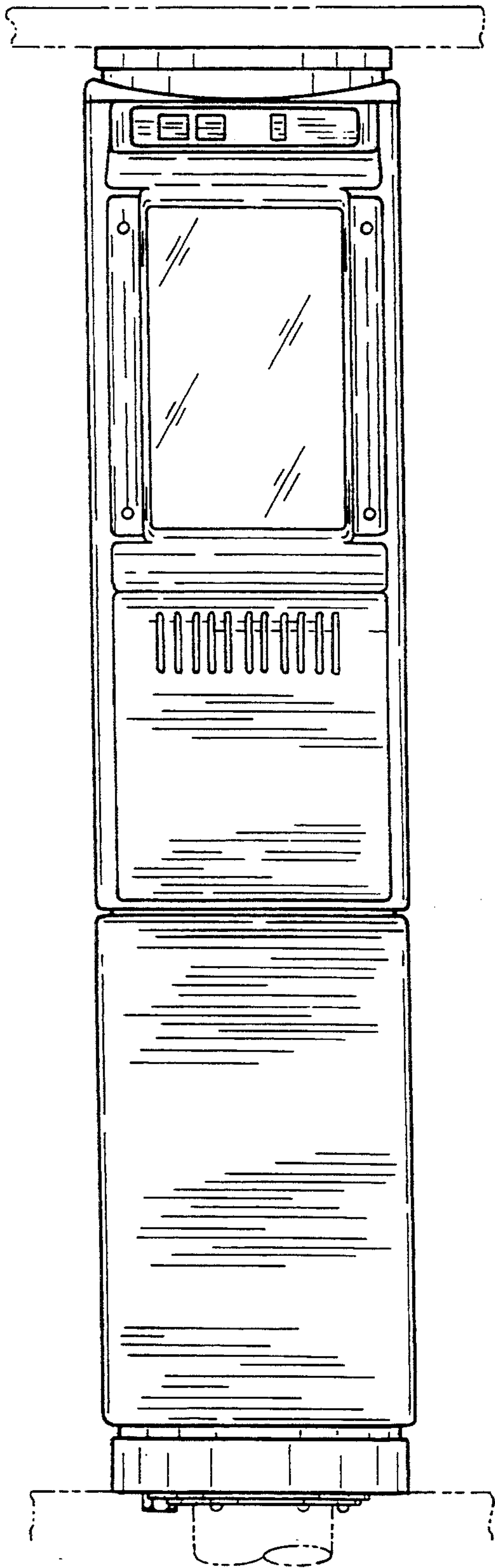

FIG. 9

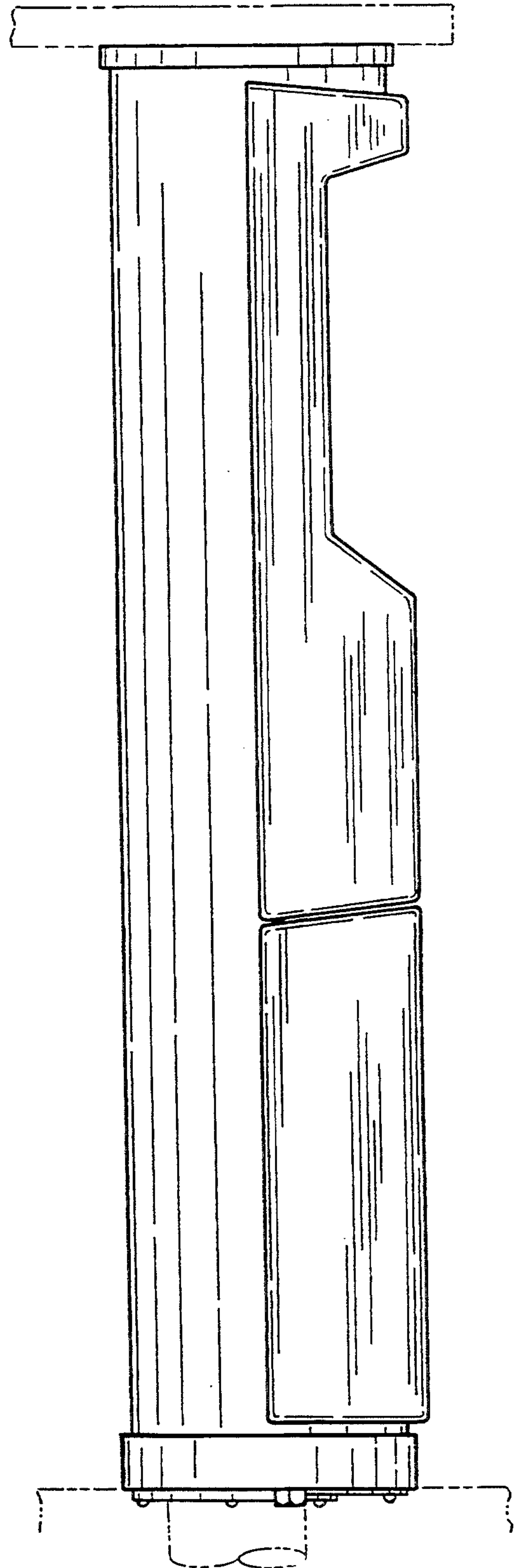

FIG. 10

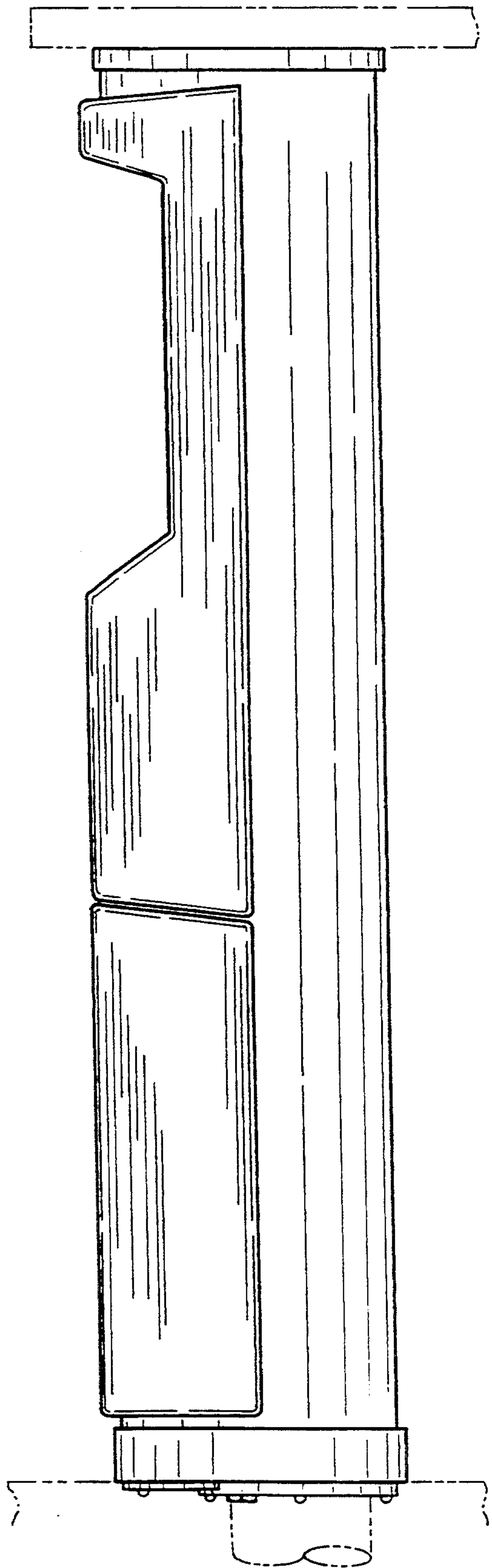

FIG. 13

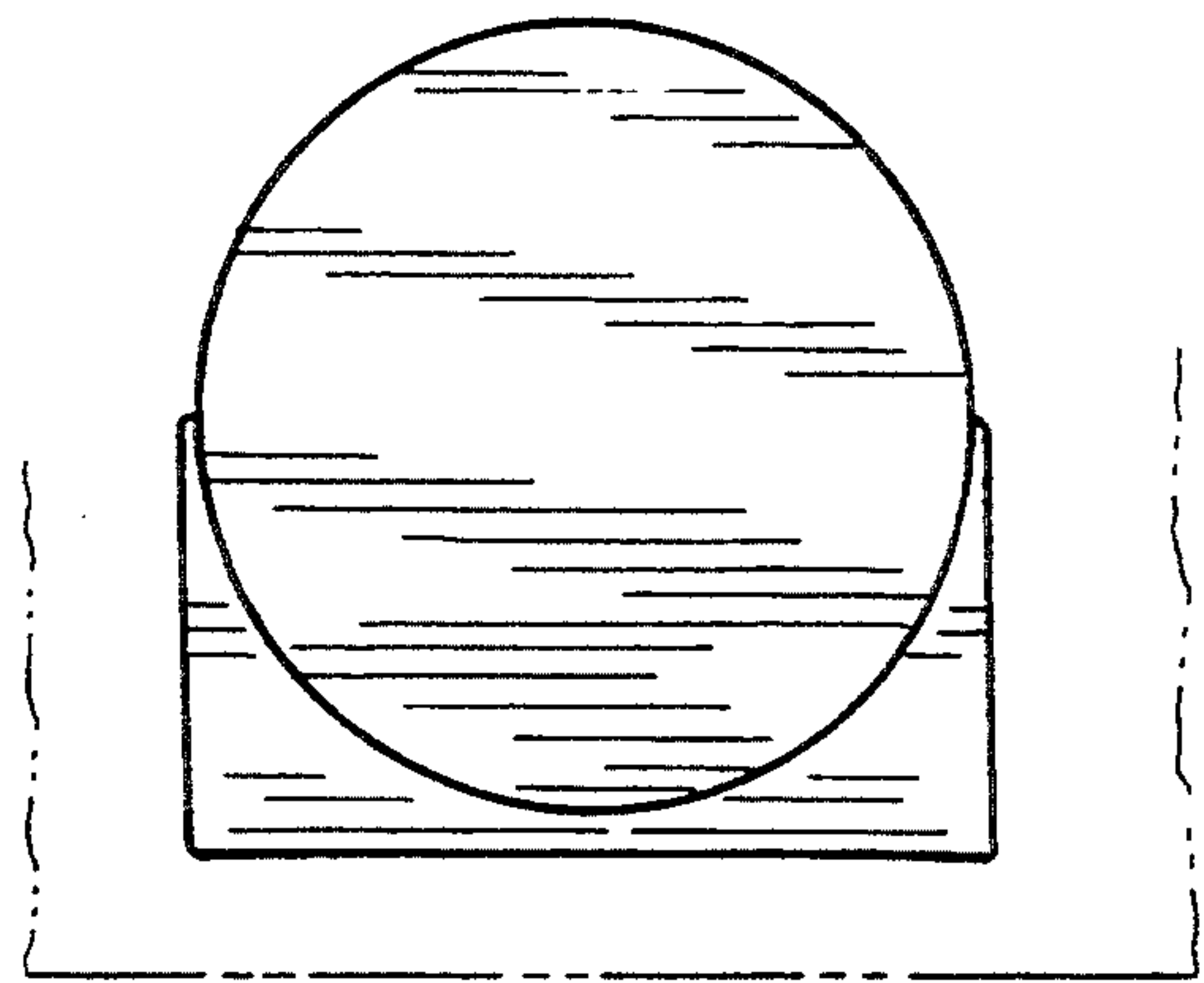

FIG. 11

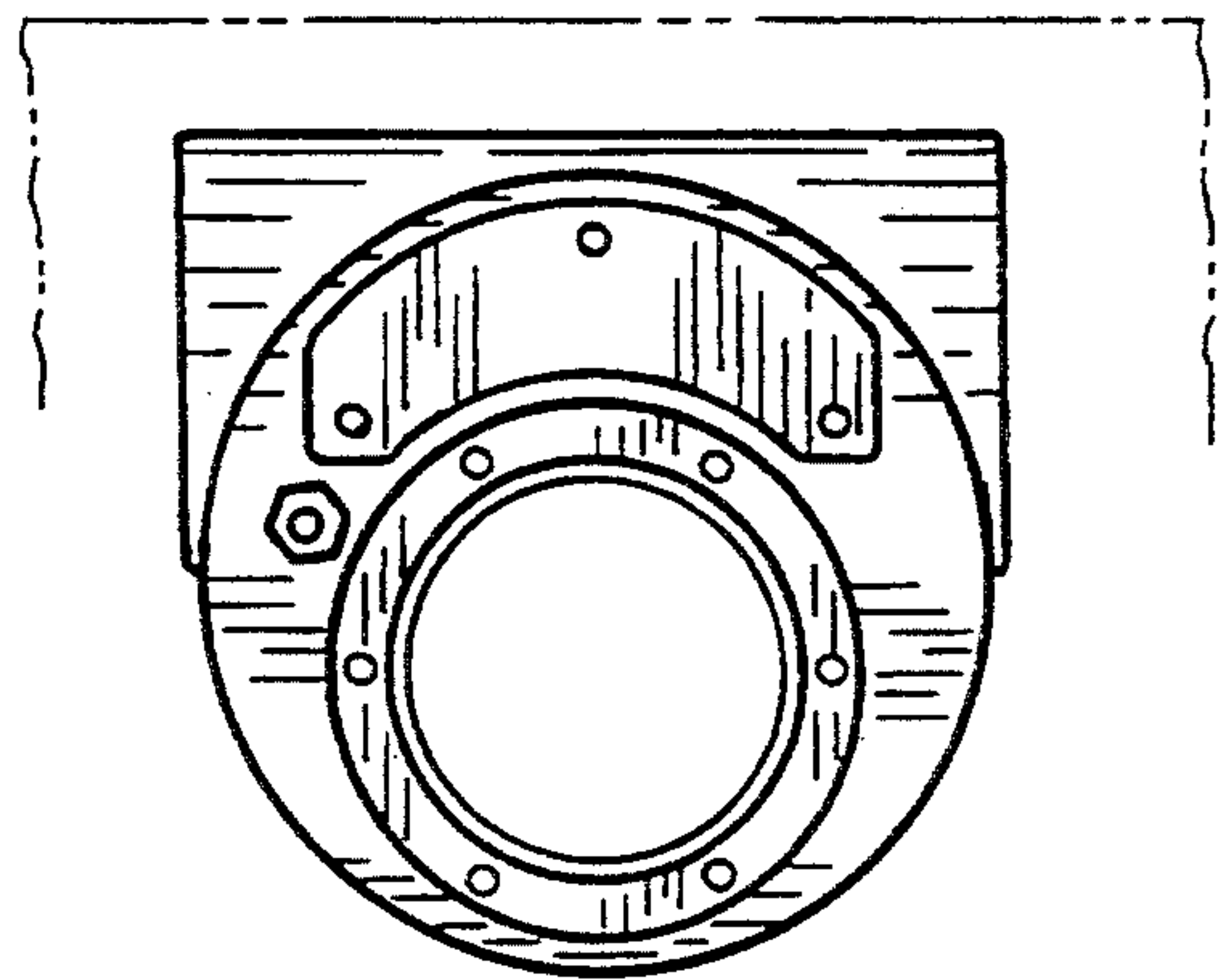

FIG. 12



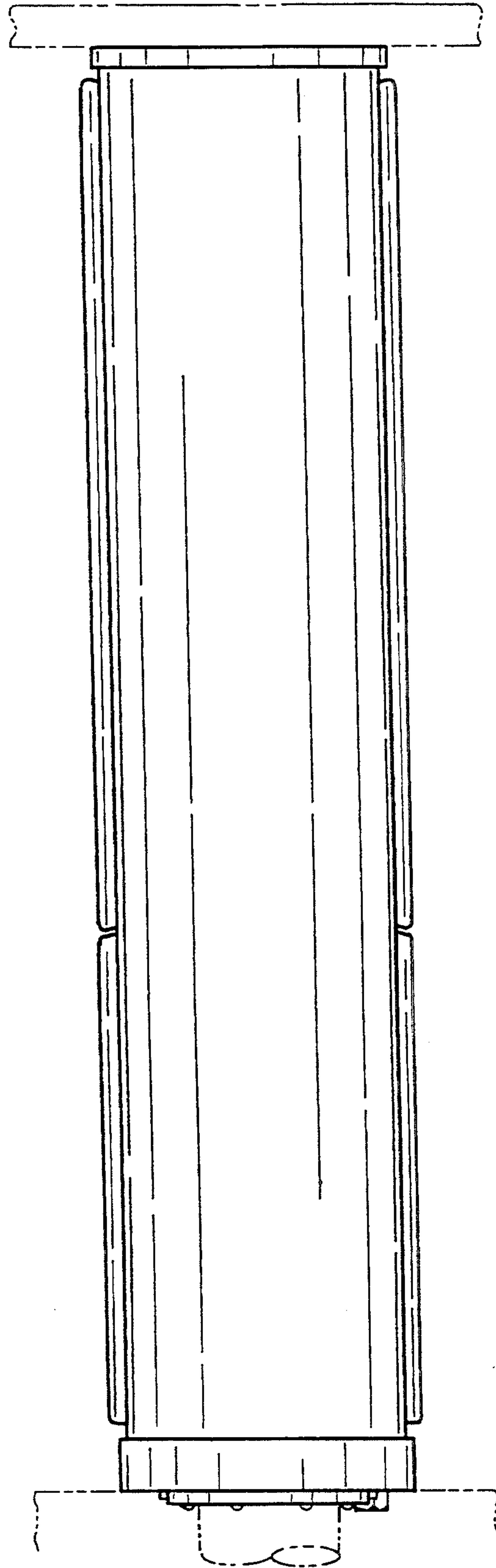

FIG. 14