



US00D361181S

United States Patent [19]

[11] Patent Number: **Des. 361,181**

Wareham et al.

[45] Date of Patent: **** Aug. 8, 1995**

[54] VACUUM CLEANER UPPER PORTION

[75] Inventors: **Richard A. Wareham**, North Canton;
Ronald J. Stephens, Rittman, both of Ohio

[73] Assignee: **The Hoover Company**, North Canton, Ohio

[**] Term: **14 Years**

[21] Appl. No.: **20,236**

[22] Filed: **Mar. 22, 1994**

[52] U.S. Cl. **D32/31**

[58] Field of Search **D32/21-22,**
D32/31-34; 15/320-321, 323, 328, 347,
350-353, 361, 335

[56] References Cited

U.S. PATENT DOCUMENTS

D. 275,428	9/1984	Wareham	D32/22
D. 277,325	1/1985	Hug	D32/22
D. 286,334	10/1986	Strohmeier	D32/22
D. 286,335	10/1986	Stohmeyer	D32/22
D. 293,727	1/1988	Wareham et al.	D32/22
D. 293,728	1/1988	Ohhira et al.	D32/22
D. 301,784	6/1989	Petralia et al.	D32/22
D. 307,658	5/1990	Ikeda et al.	D32/22
D. 309,806	8/1990	Chieda et al.	D32/22
D. 313,681	1/1991	McKnight	D32/22
D. 314,260	1/1991	Lee	D32/22
D. 315,042	2/1991	Ikeda	D32/22
D. 338,295	8/1993	Kieft	D32/31
D. 346,053	4/1994	Hoshino	D32/22
5,247,719	9/1993	Wareham et al.	15/323

OTHER PUBLICATIONS

Regina ® Model H06309—Purchased 25 Aug. 1992 (Photo).

Regina ® Model H06307—Purchased 29 Aug. 1992 (Photo).

Kenmore Model 116.3341090—Purchased 27 Sep. 1993 (Photo).

Primary Examiner—Ruth McInroy

[57] CLAIM

The ornamental design for a vacuum cleaner upper portion, as shown and described.

DESCRIPTION

FIG. 1 is a front elevational view of the vacuum cleaner upper portion showing our new design; FIG. 2 is a right side elevational view thereof; FIG. 3 is a rear elevational view thereof; FIG. 4 is a left side elevational view thereof; FIG. 5 is a top plan view thereof; FIG. 6 is a bottom plan view thereof; FIG. 7 is a front elevational view of a second embodiment of our invention; FIG. 8 is a right side elevational view thereof; FIG. 9 is a left side elevational view thereof; and, FIG. 10 is a top plan view thereof.

The bottom plan and rear elevational views of the second embodiment of the invention are the same as these two views in the first embodiment.

The portion of the vacuum cleaner shown in broken lines in FIGS. 1-4 is shown for illustrative purposes only and forms no part of the claimed design.

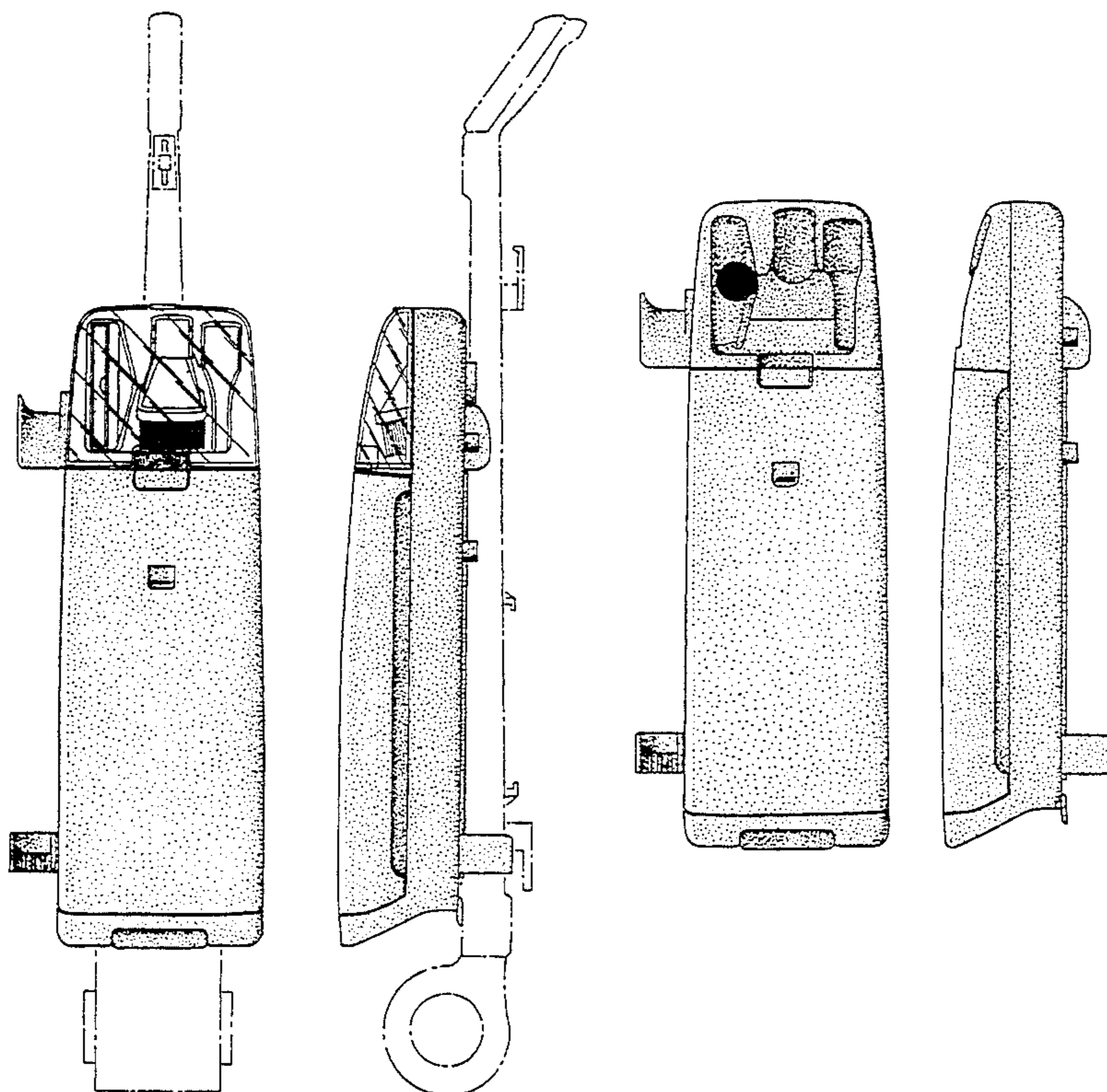

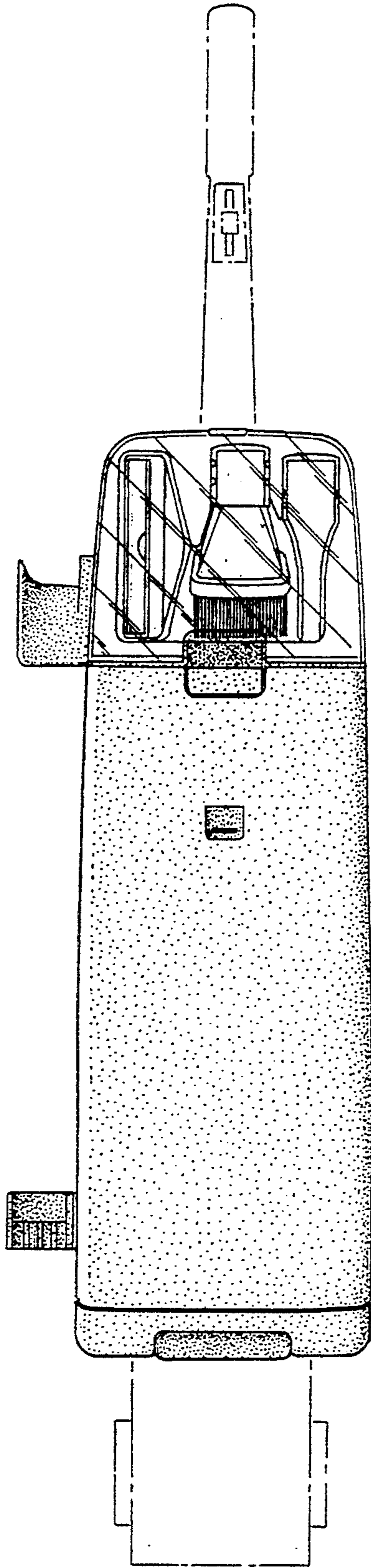

FIG. -1

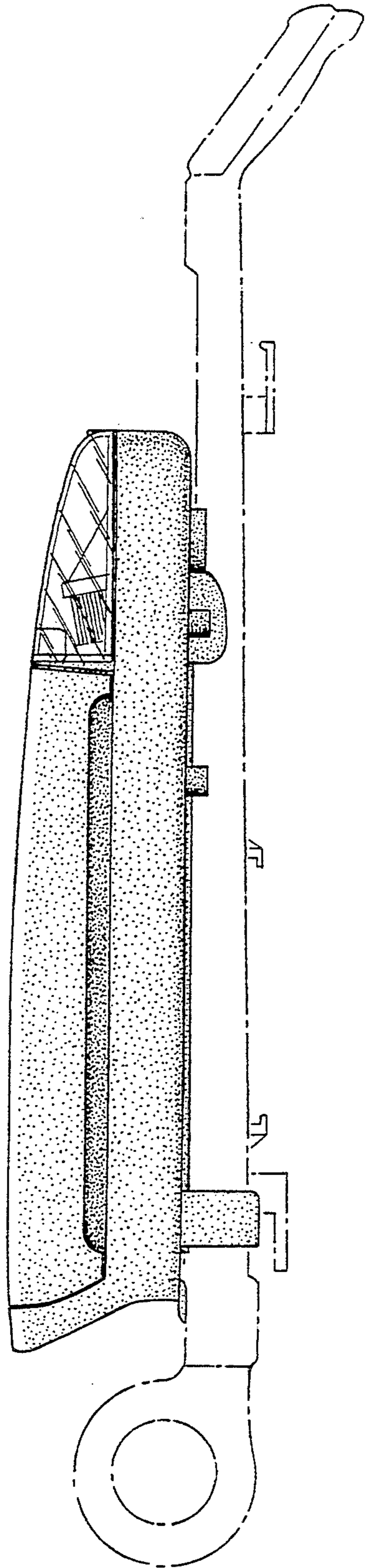

FIG. -2

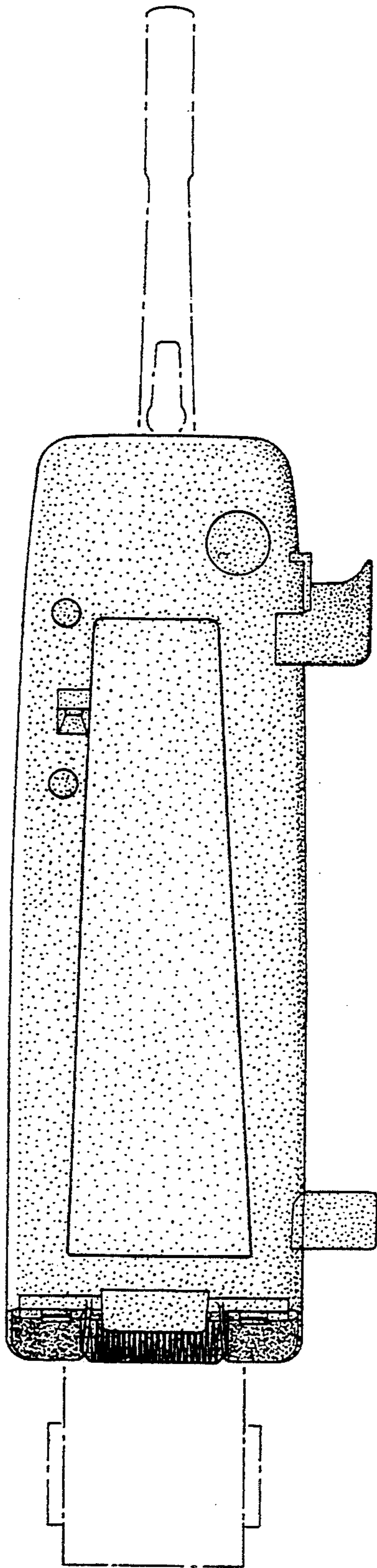

FIG.-3

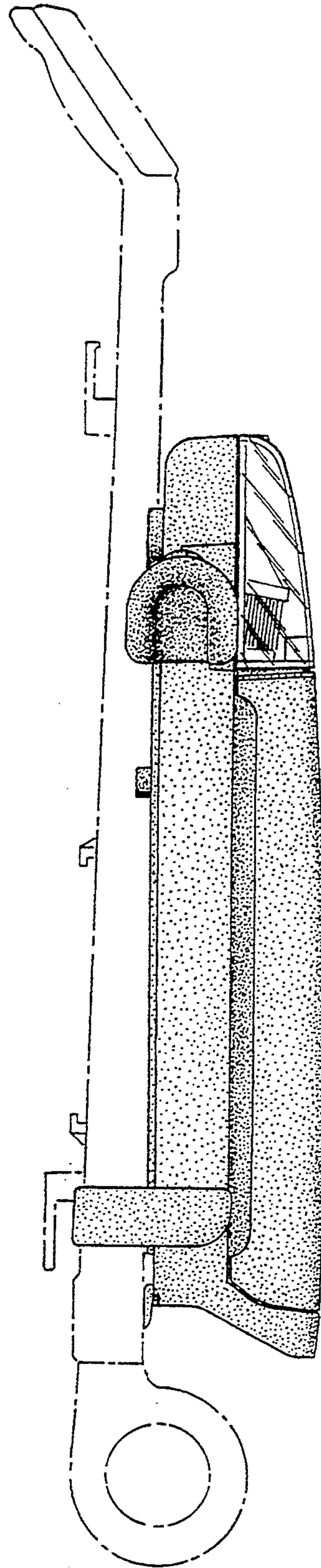

FIG.-4

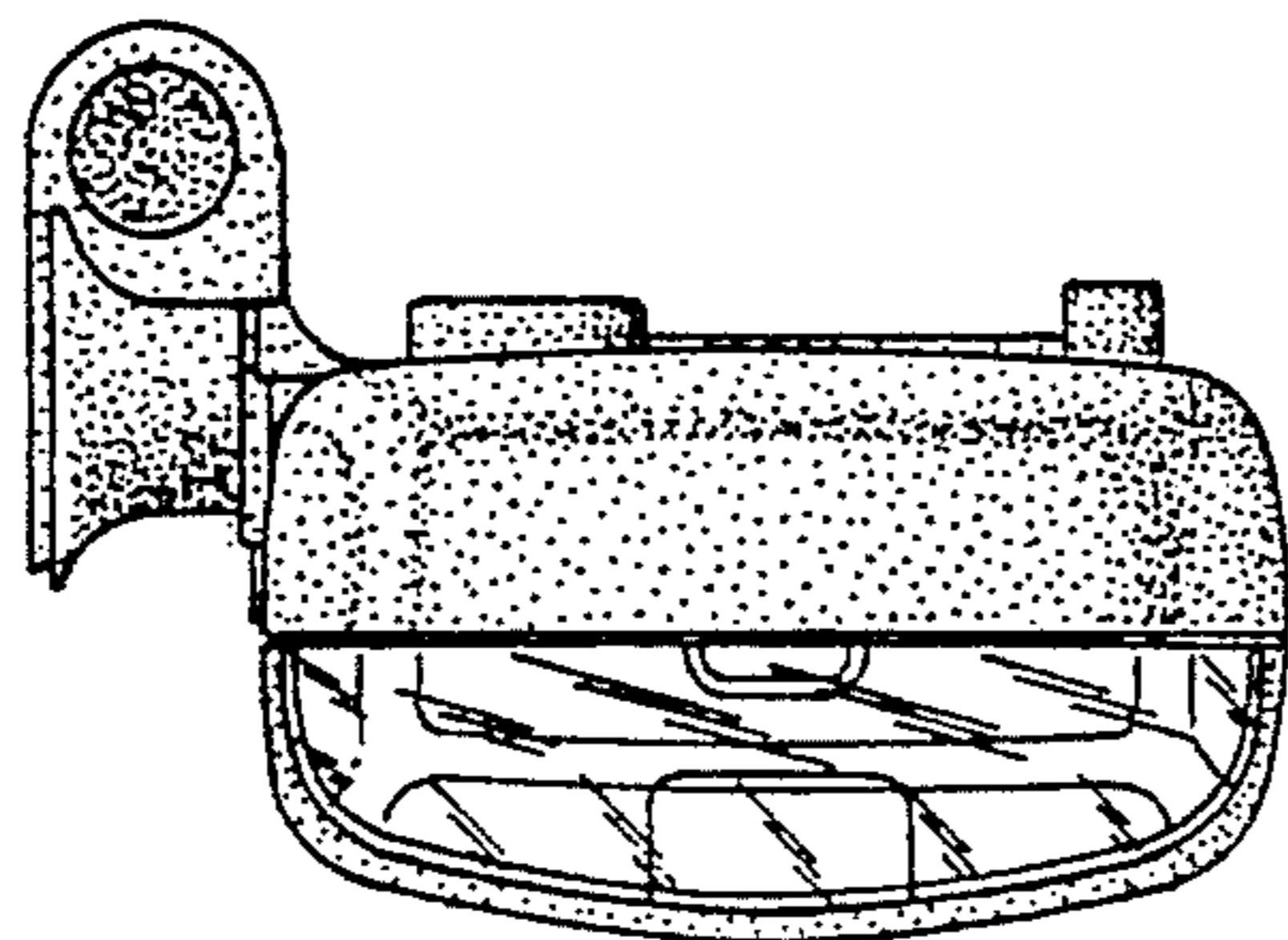

FIG.-5

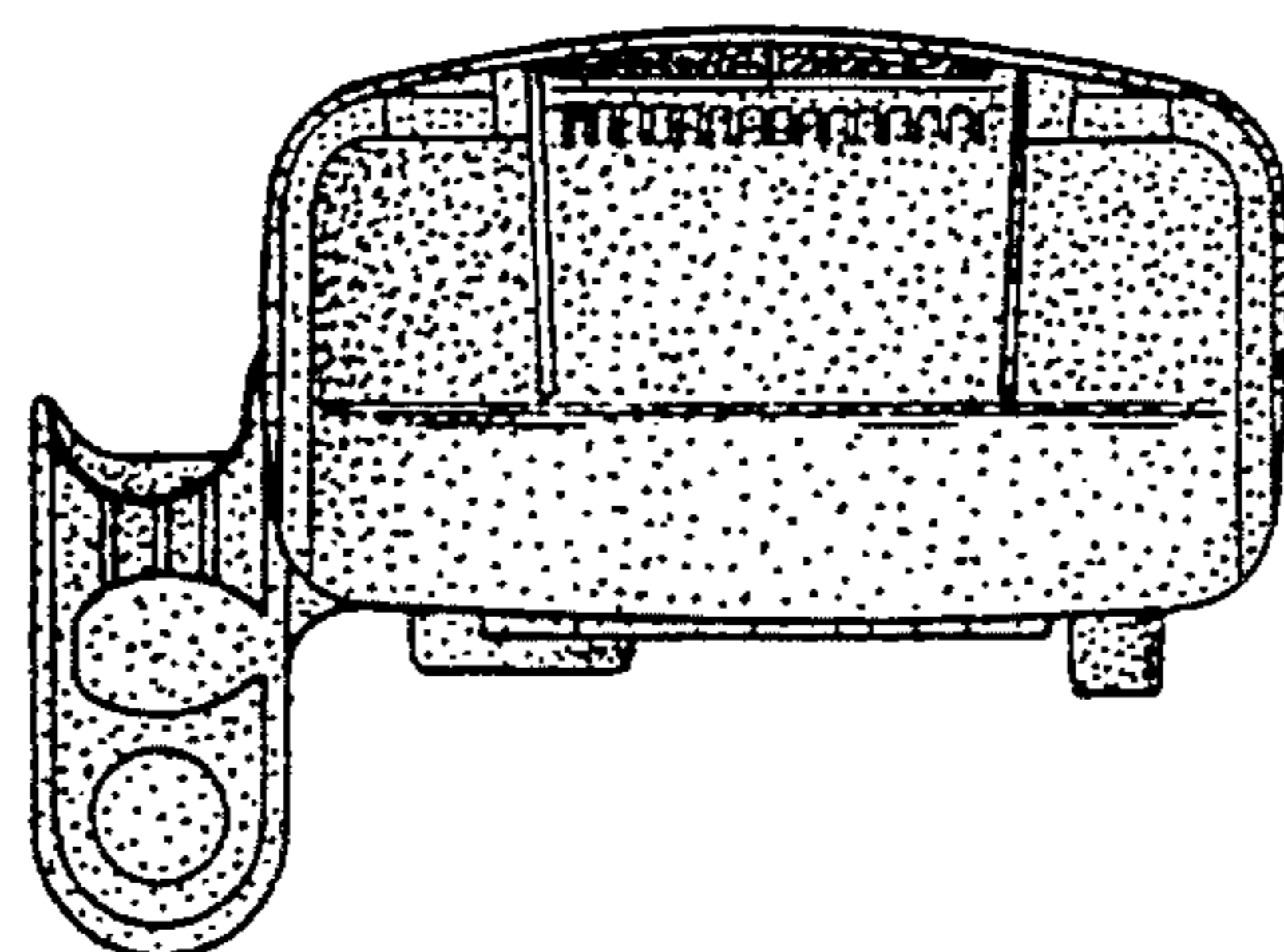

FIG.-6

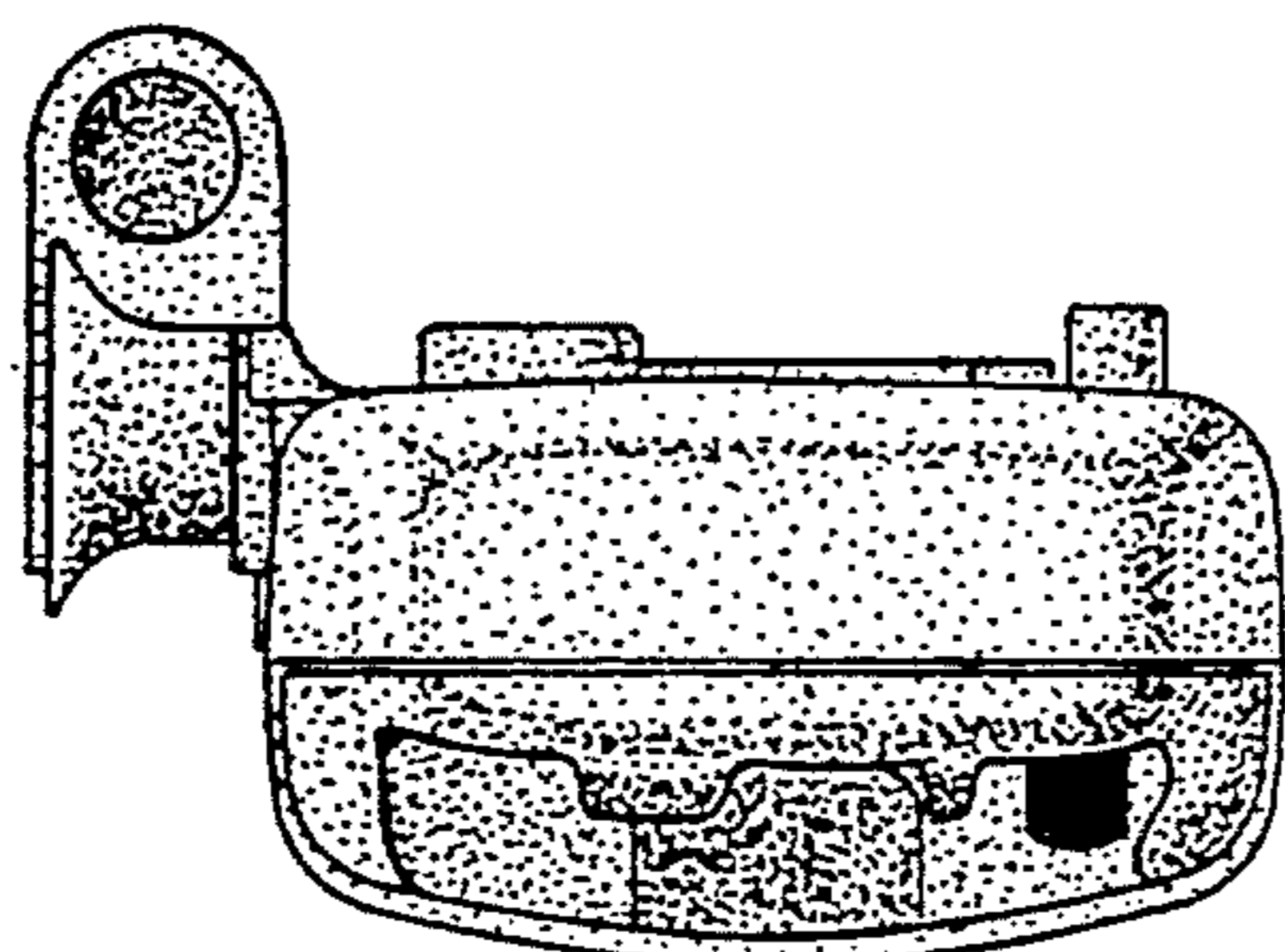

FIG.-10

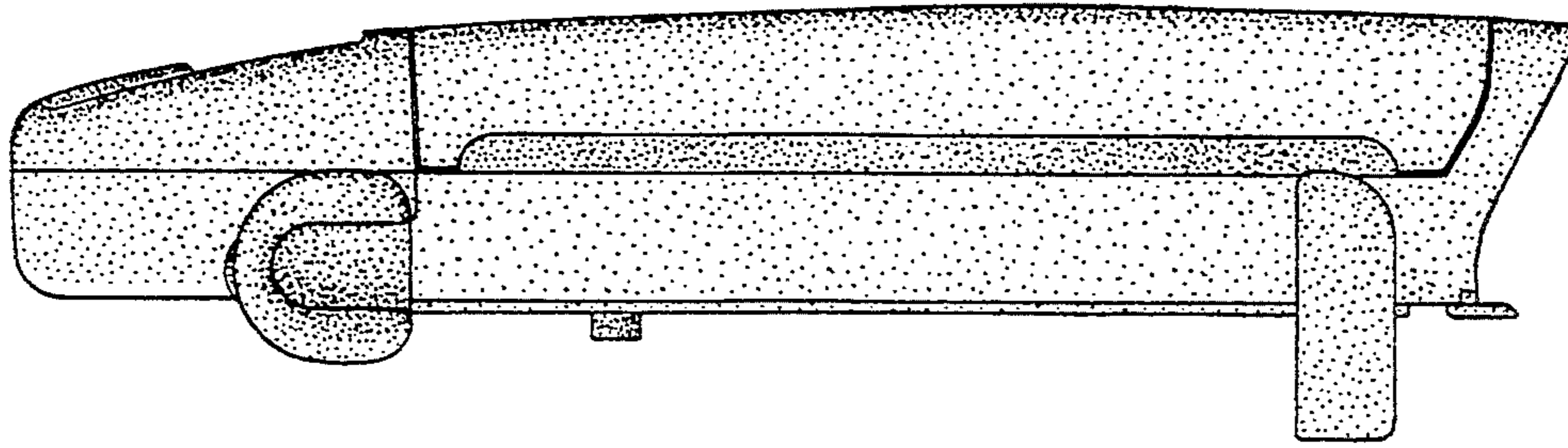

FIG. 9

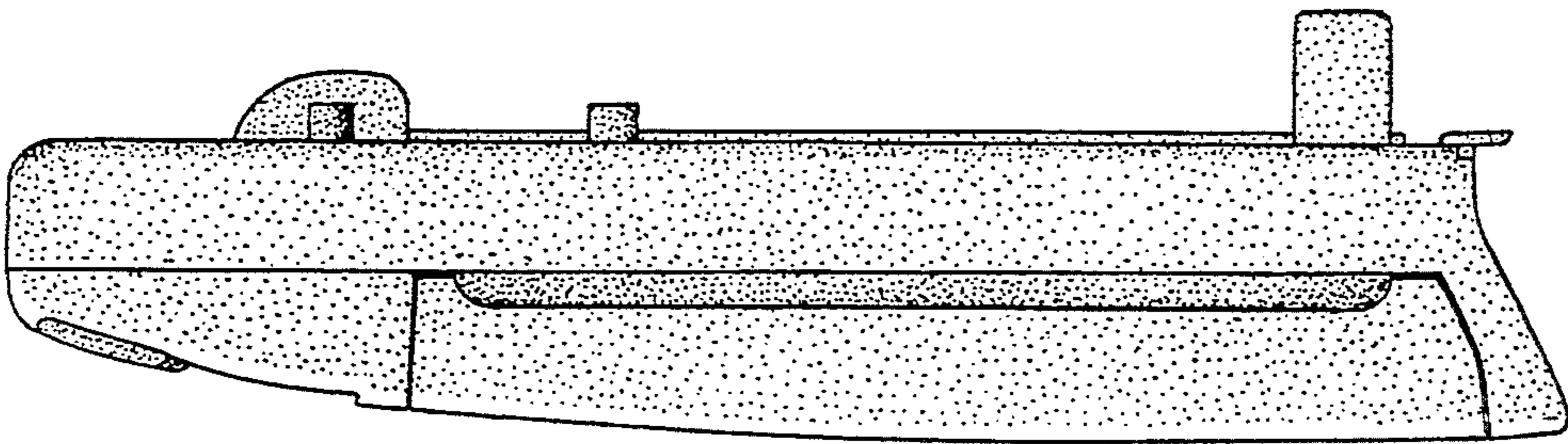

FIG. 8

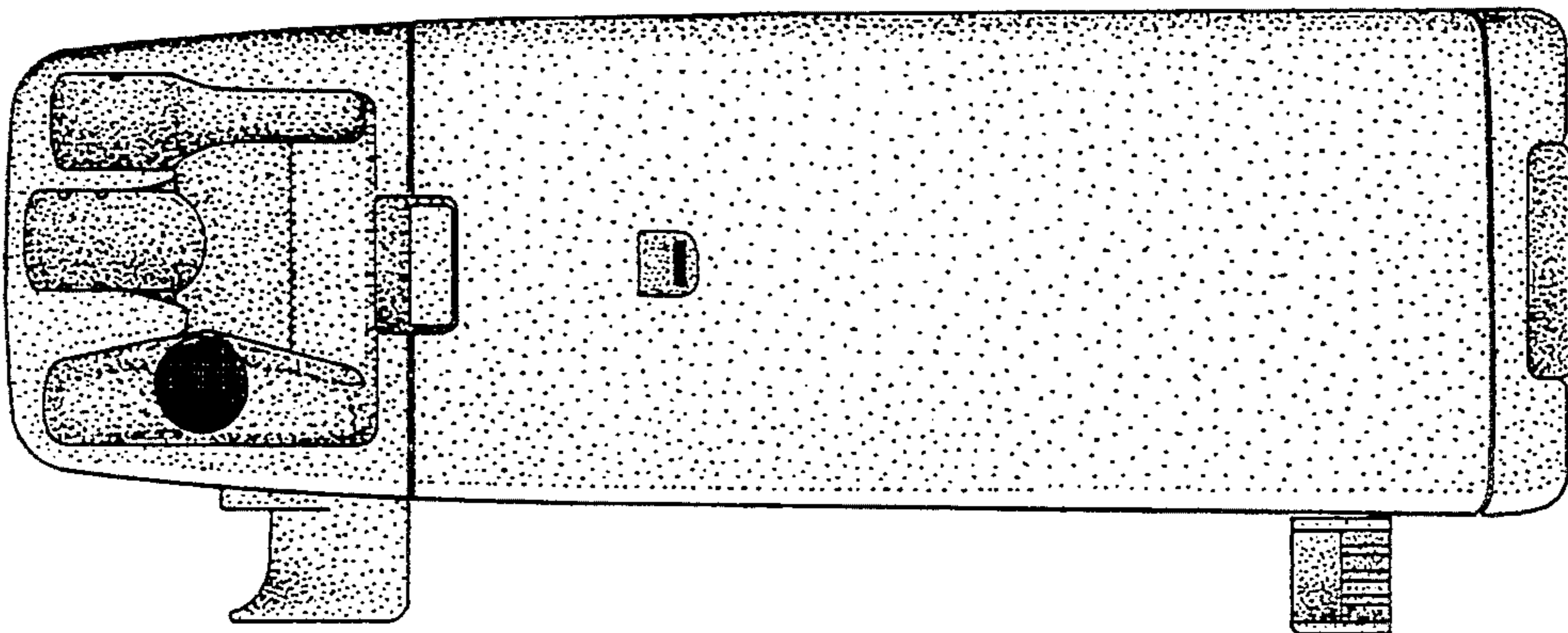

FIG. 7