



US00D361169S

United States Patent [19]

[11] Patent Number: **Des. 361,169**

Ichikawa

[45] Date of Patent: **** Aug. 8, 1995**

[54] AQUARIUM TANK

[75] Inventor: **Minoru Ichikawa, Tokyo, Japan**

[73] Assignee: **Nisso Industry Co., Ltd., Tokyo, Japan**

[**] Term: **14 Years**

[21] Appl. No.: **16,233**

[22] Filed: **Dec. 10, 1993**

[52] U.S. Cl. **D30/101**

[58] Field of Search 119/269, 245, 248, 267, 119/265, 266, 246; D30/101, 104, 106-107; D11/145; 47/69 T

60-34403	8/1985	Japan .	
60-34404	8/1985	Japan .	
60-34405	8/1985	Japan .	
61-8076	3/1986	Japan .	
61-8077	3/1986	Japan .	
63-31001	8/1988	Japan .	
1-33847	9/1989	Japan .	
2-39818	11/1990	Japan .	
2-39819	11/1990	Japan .	
6007865	1/1977	Netherlands	119/245
1419411	12/1975	United Kingdom	119/269

[56] **References Cited**

U.S. PATENT DOCUMENTS

D. 236,632	9/1975	Shalom	D30/101
2,491,853	12/1949	Feldman	D30/101
2,715,794	8/1955	Atkinson	47/69
2,792,811	5/1957	Chiaro	119/269
3,721,366	3/1973	Battershall et al.	119/269
4,191,129	3/1980	Rinny	119/269
4,889,973	12/1989	Farinacci et al.	119/245
5,009,190	4/1991	Gordon	119/265
5,299,424	4/1994	Woodson et al.	119/245

FOREIGN PATENT DOCUMENTS

59-18460	5/1984	Japan .
59-18461	5/1984	Japan .
60-31014	7/1985	Japan .
60-31016	7/1985	Japan .
60-34401	8/1985	Japan .
60-34402	8/1985	Japan .

OTHER PUBLICATIONS

Rain Forest Aquarium brochure.

Primary Examiner—Cathy Anne MacCormac

[57] **CLAIM**

The ornamental design for an aquarium tank, as shown and described.

DESCRIPTION

FIG. 1 is a front elevational view thereof;
 FIG. 2 is a rear elevational view thereof;
 FIG. 3 is a right side elevational view thereof, the left side elevational view being a mirror image of of the side shown;
 FIG. 4 is a top plan view thereof;
 FIG. 5 is a bottom plan view thereof;
 FIG. 6 is a cross-sectional view taken along line 6—6 in FIG. 3;
 FIG. 7 is a cross-sectional view taken along line 7—7 in FIG. 1; and,
 FIG. 8 is a front, top and right side perspective view thereof.

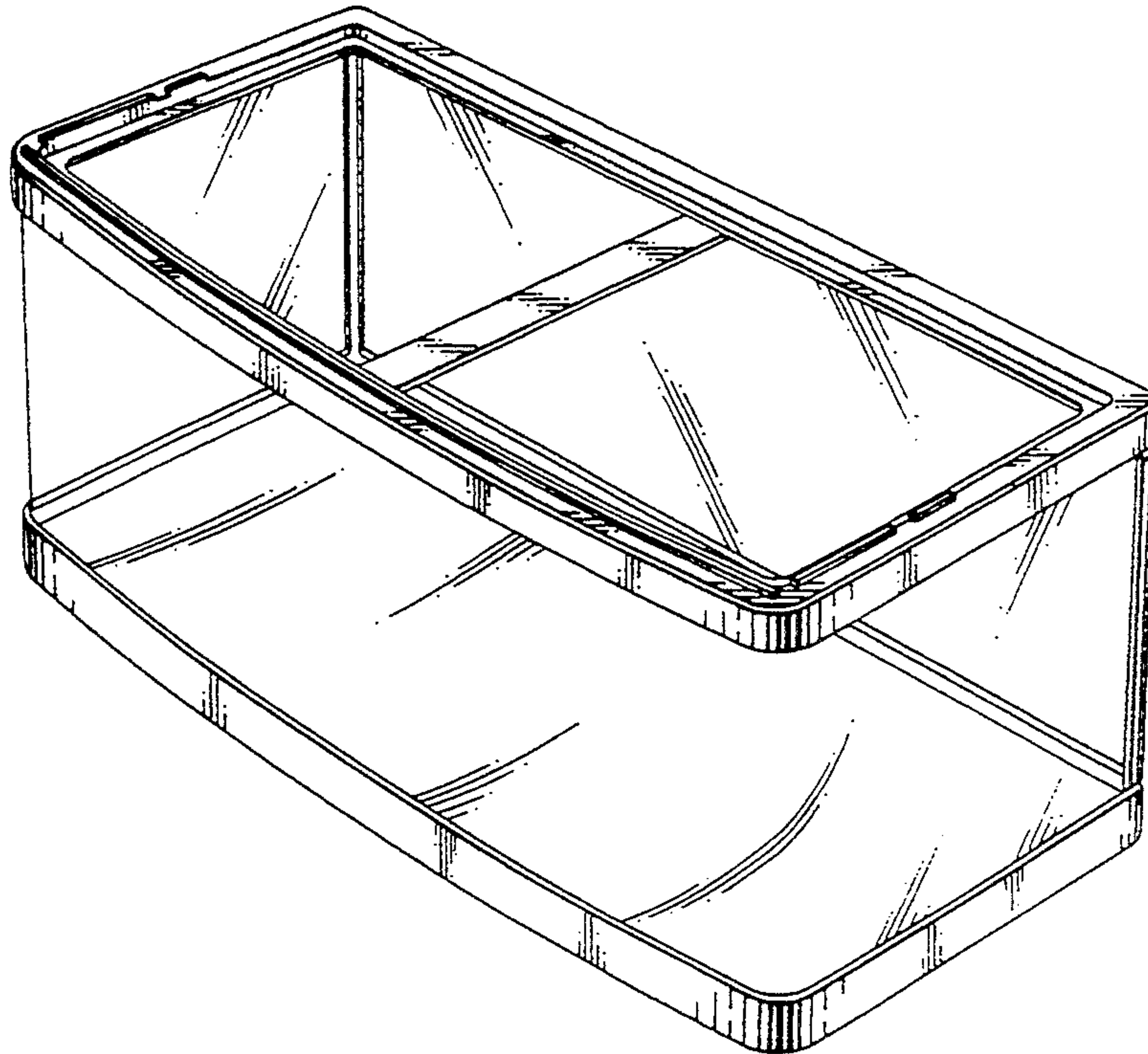

FIG. 1

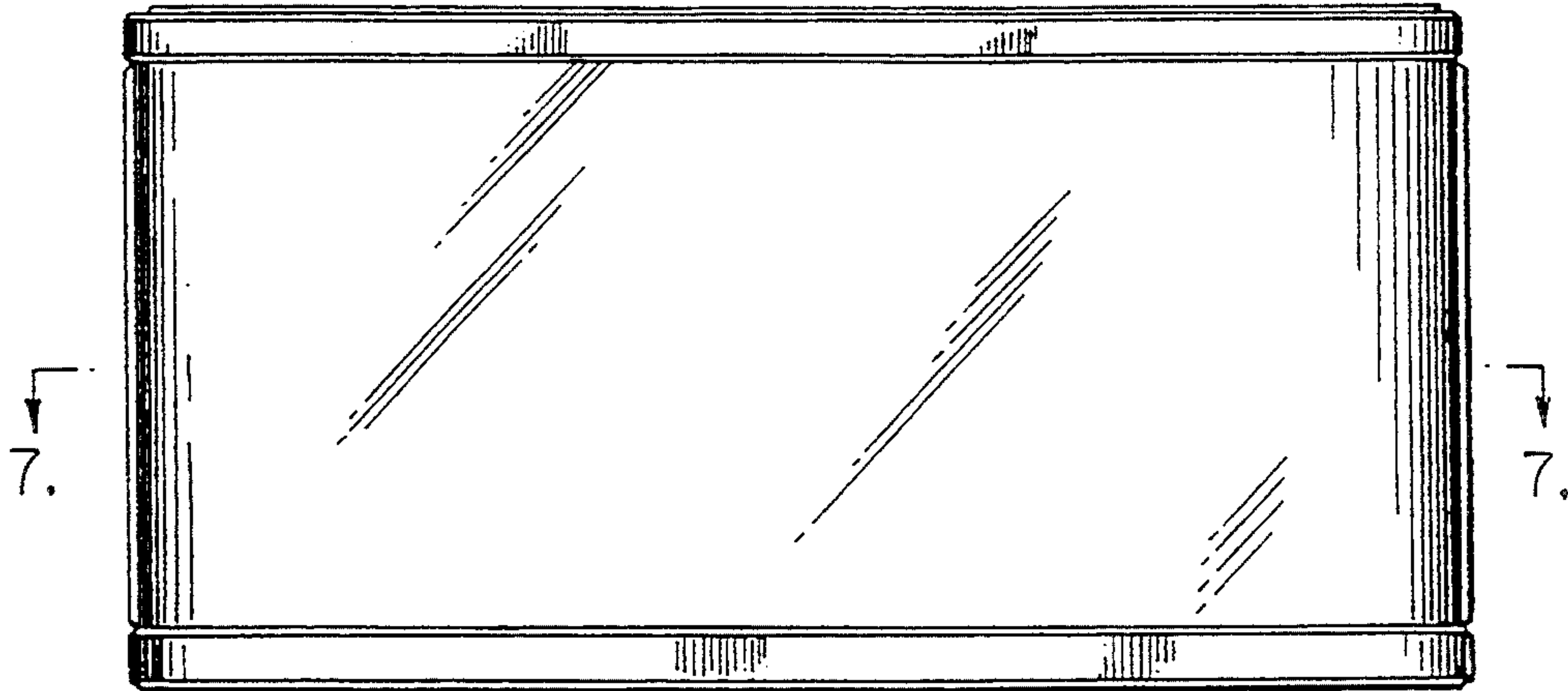

FIG. 2

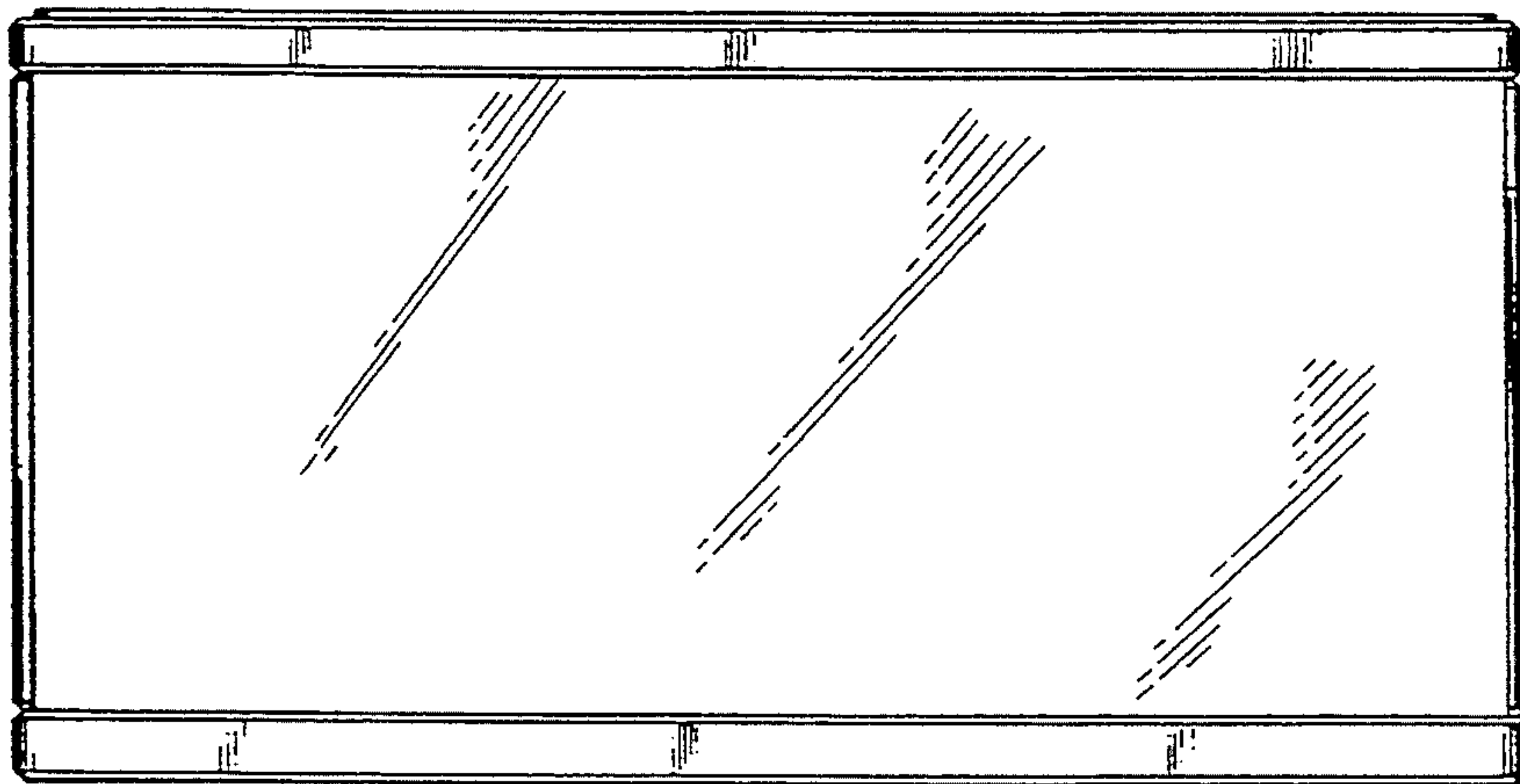

FIG. 3

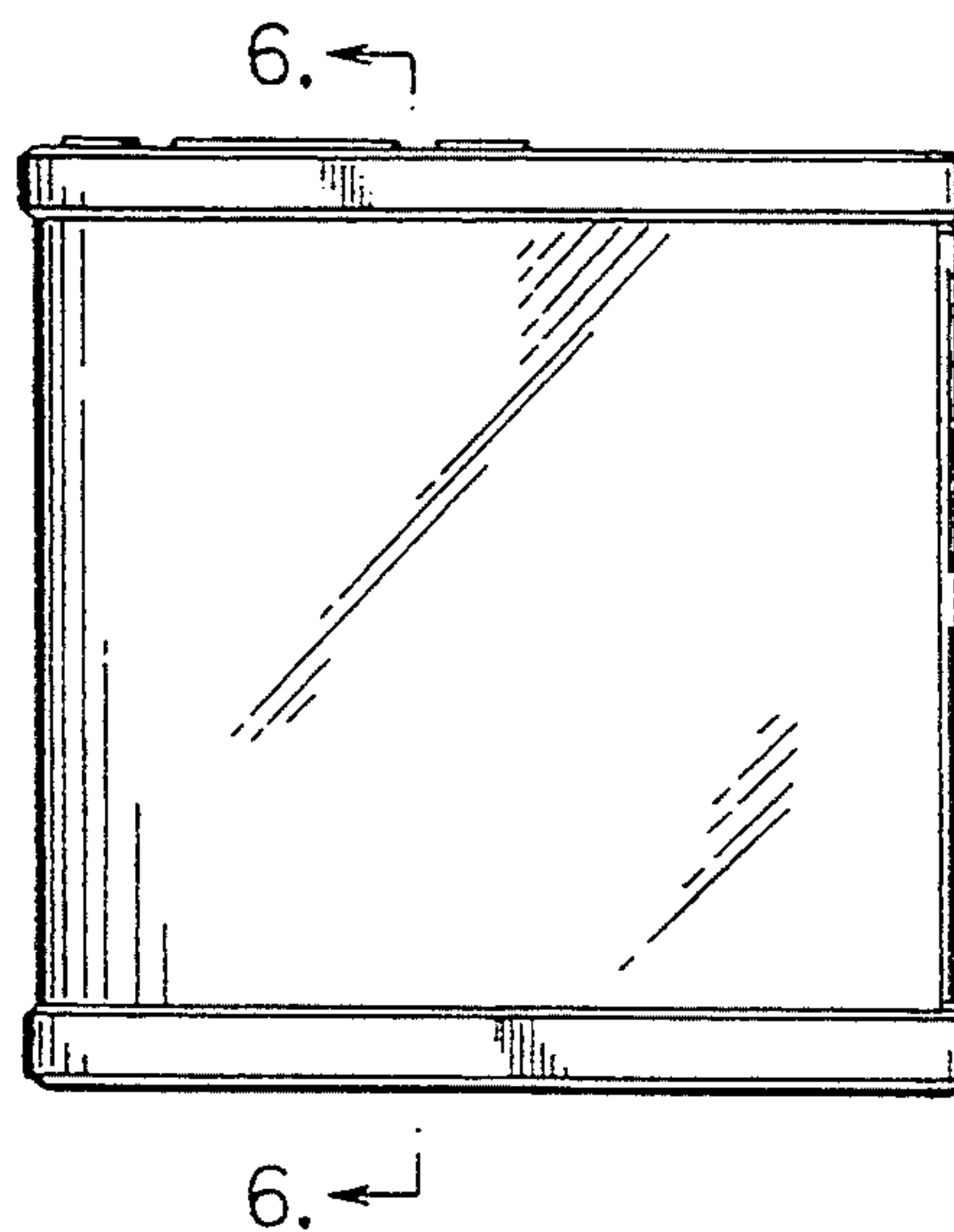

FIG. 4

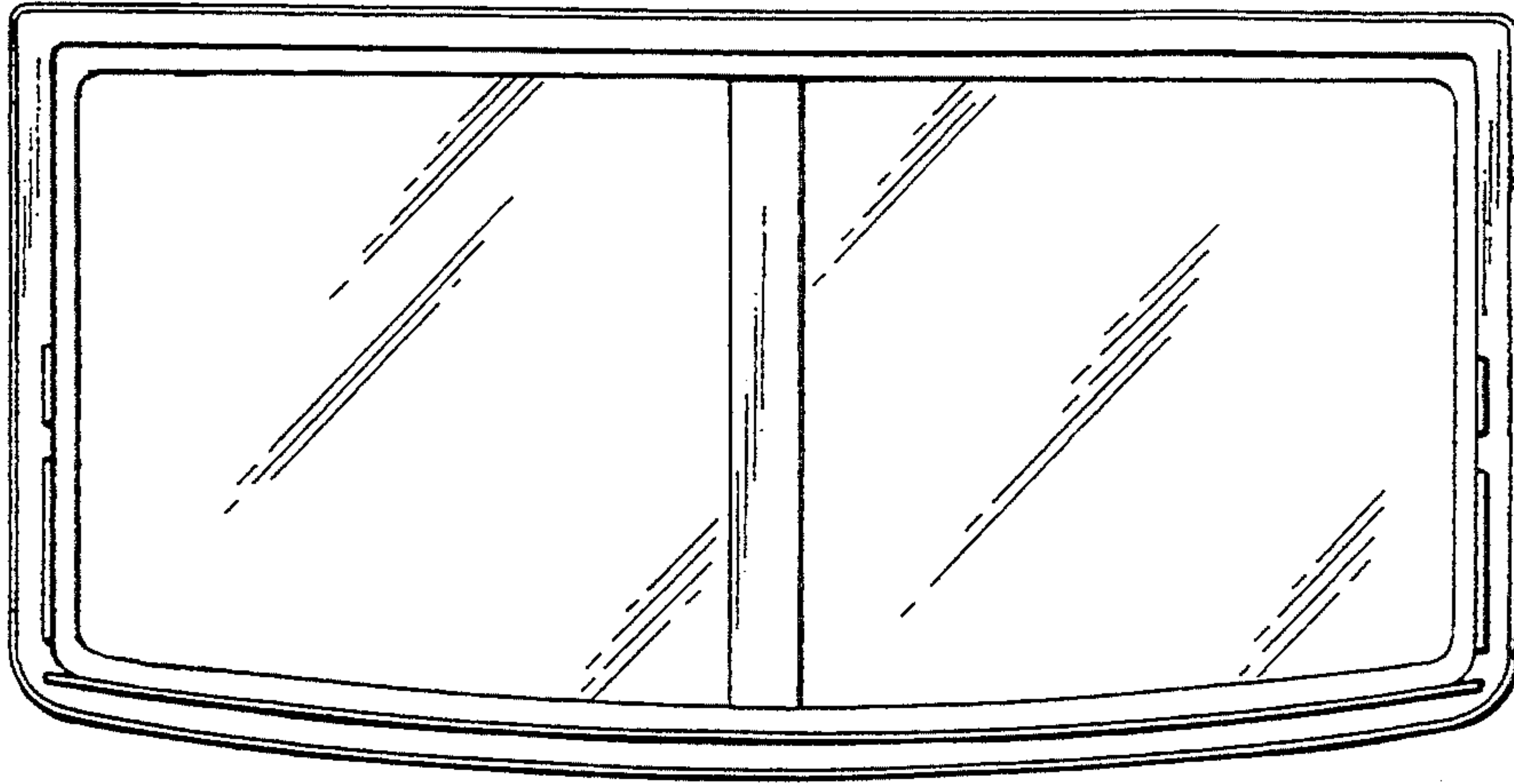

FIG. 5

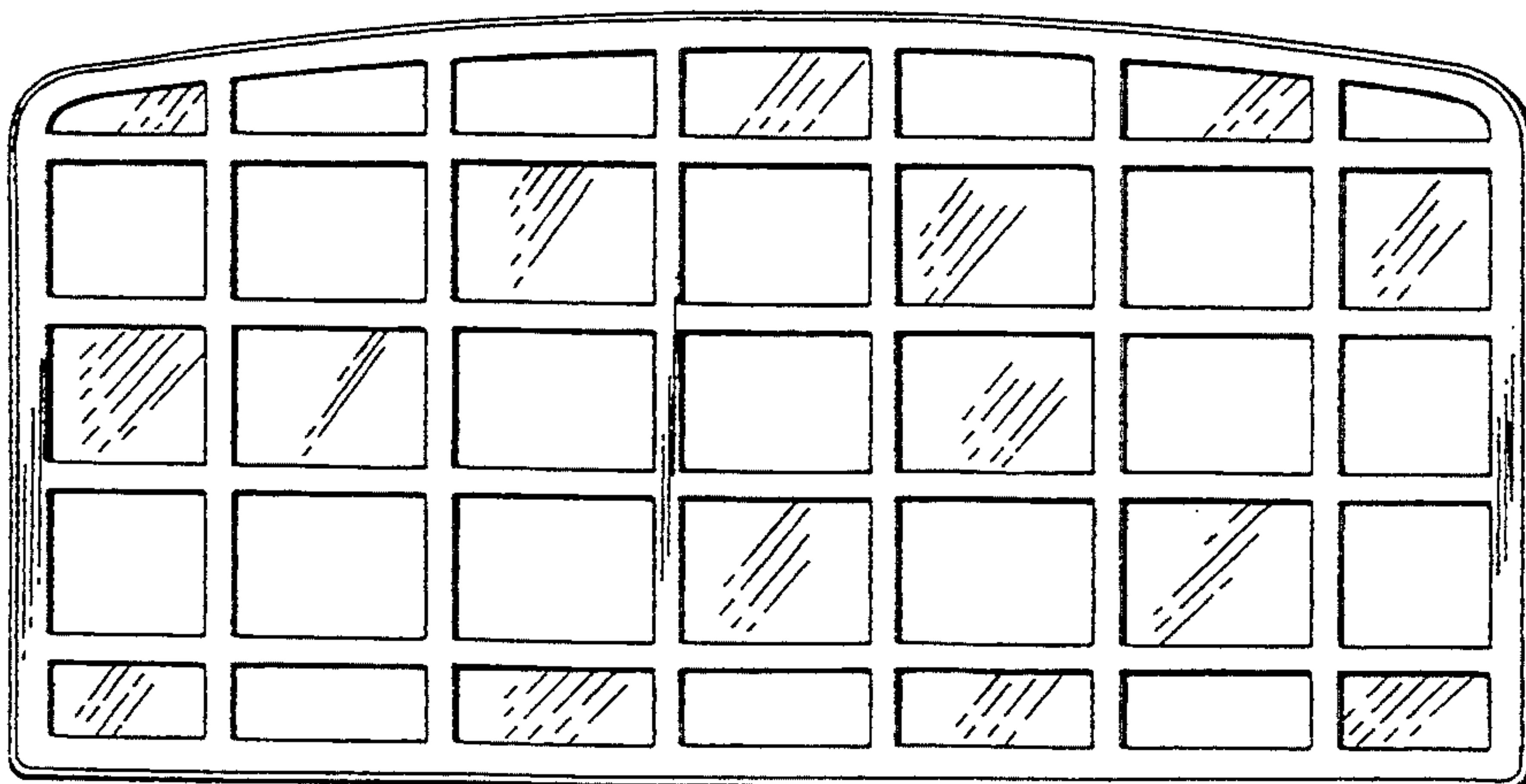

FIG. 6

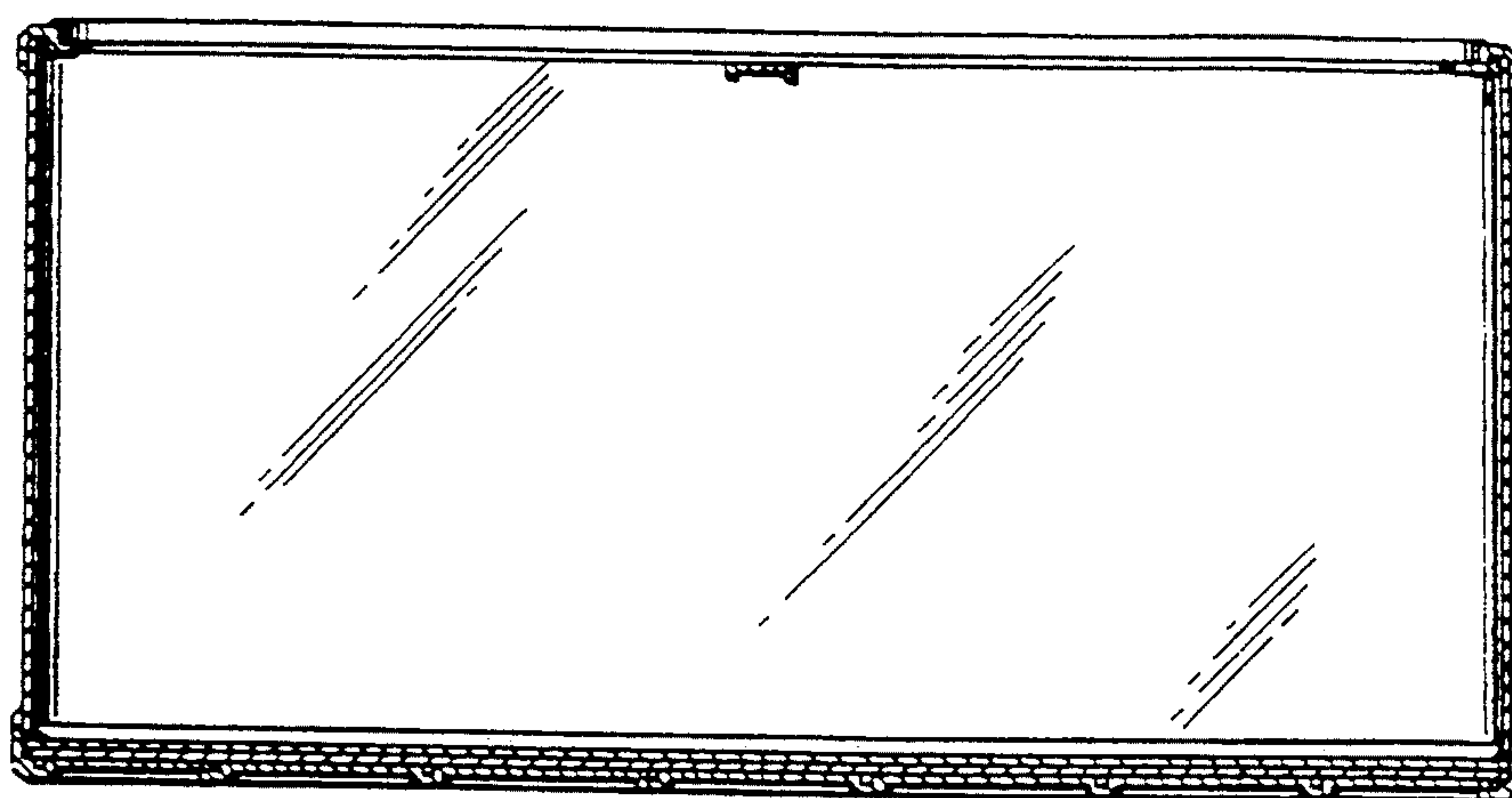

FIG. 7

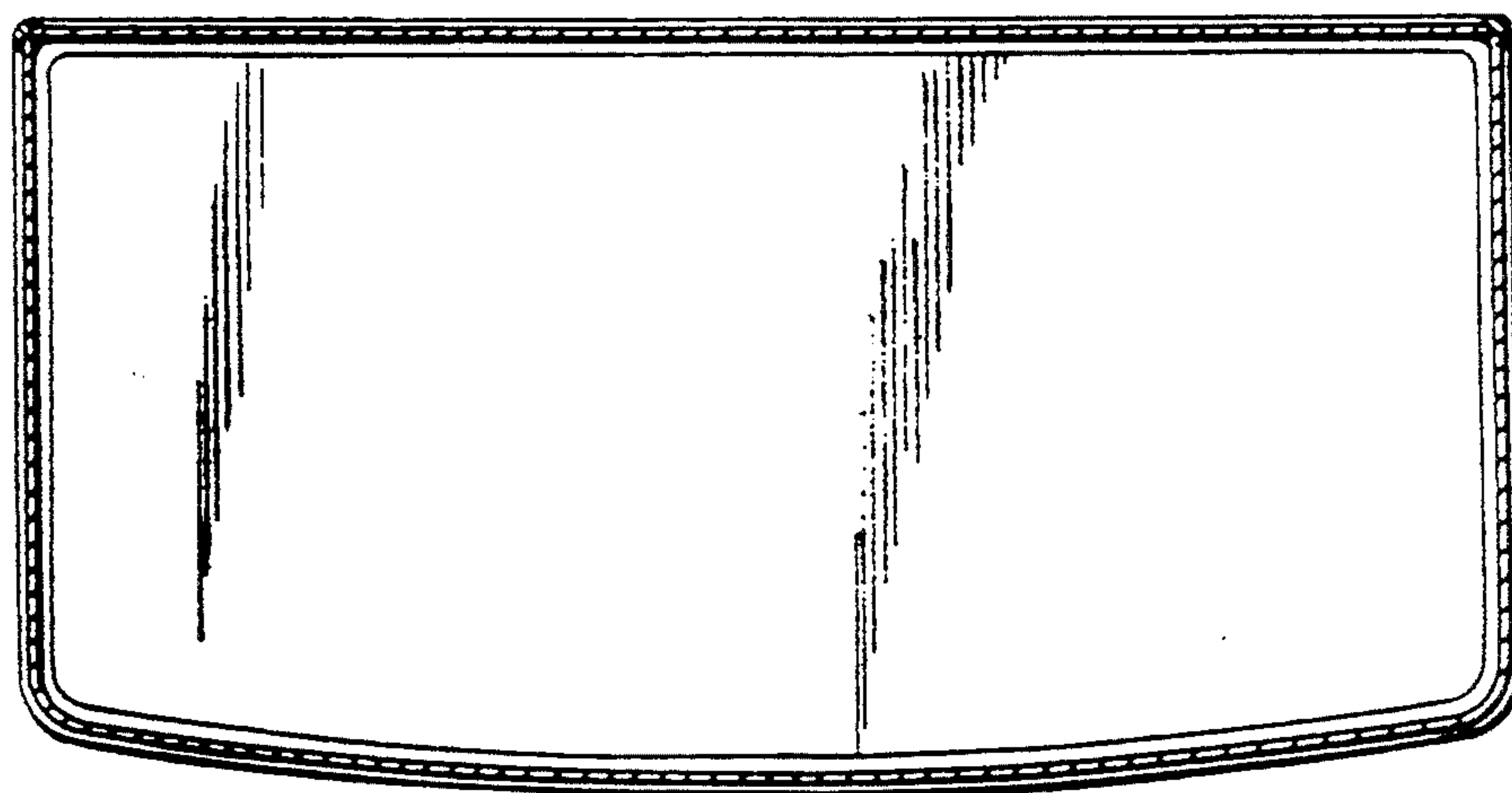

FIG. 8

