



US00D361091S

United States Patent [19]

[11] Patent Number: **Des. 361,091**

Scholfield

[45] Date of Patent: **** Aug. 8, 1995**

[54] **ROLL PAPER NOTE PAD**

[76] Inventor: **Richard P. Scholfield**, 4608 Eastlake Cir., Sarasota, Fla. 34232

[**] Term: **14 Years**

[21] Appl. No.: **12,731**

[22] Filed: **Sep. 9, 1993**

[52] U.S. Cl. **D19/78; D19/77; D19/89**

[58] Field of Search **D6/515-523; D19/77-78, 89; 211/69.1-69.9, 13, 126**

[56] **References Cited**

U.S. PATENT DOCUMENTS

- D. 91,233 12/1933 Connaway .
- D. 118,936 2/1940 Guild .
- D. 138,852 9/1944 King .
- D. 142,612 10/1945 Bletzinger .
- D. 154,294 6/1949 Marlow .
- D. 181,579 12/1956 Dodge D19/89 X
- D. 181,579 12/1957 Dodge .
- D. 287,374 12/1986 Macowski D19/89
- D. 288,762 3/1987 Loughridge D6/518
- D. 337,613 7/1993 Peersmann D19/78
- D. 346,622 5/1994 Miller D19/78

- 1,539,994 6/1925 Cooper .
- 1,713,857 5/1929 Rapp .
- 2,047,255 7/1936 Colburn .
- 3,273,846 9/1966 De Mare .
- 3,691,854 9/1972 Barthruff .
- 4,066,171 1/1978 Fowlie 211/69.1
- 4,877,197 10/1989 Nelson .

Primary Examiner—Brian N. Vinson
Attorney, Agent, or Firm—Cushman, Darby & Cushman

[57] **CLAIM**

The ornamental design for a roll paper note pad, as shown and described.

DESCRIPTION

FIG. 1 is a side perspective view of the roll paper note pad showing my new design, which may be placed on a horizontal surface or attached to a vertical wall, the pencil holder being pivotable to accommodate the orientation selected;

FIG. 2 is a top plan view thereof;

FIG. 3 is a bottom plan view thereof;

FIG. 4 is a left side view thereof;

FIG. 5 is a right side view thereof;

FIG. 6 is a front view thereof; and,

FIG. 7 is a rear view thereof.

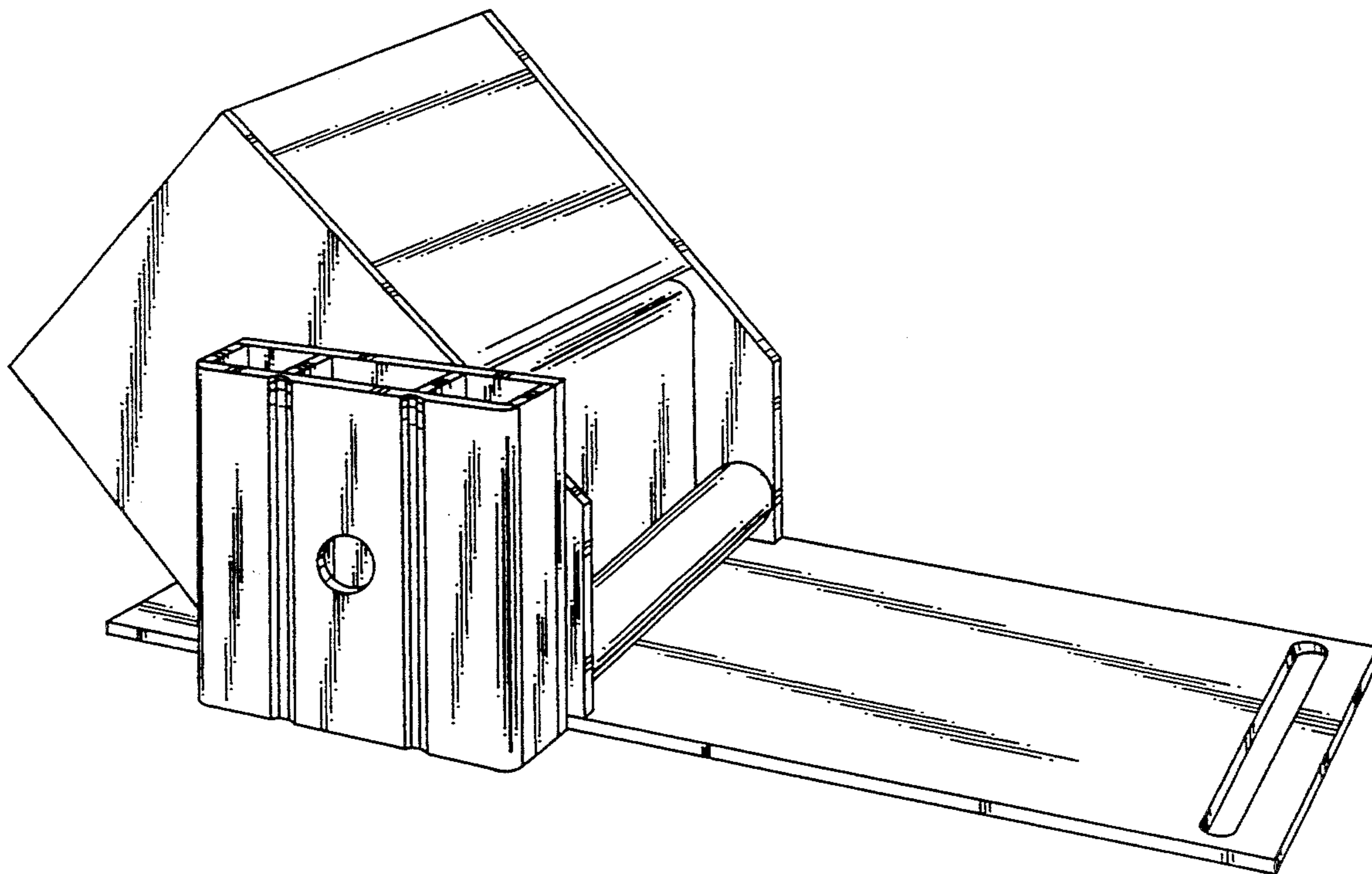

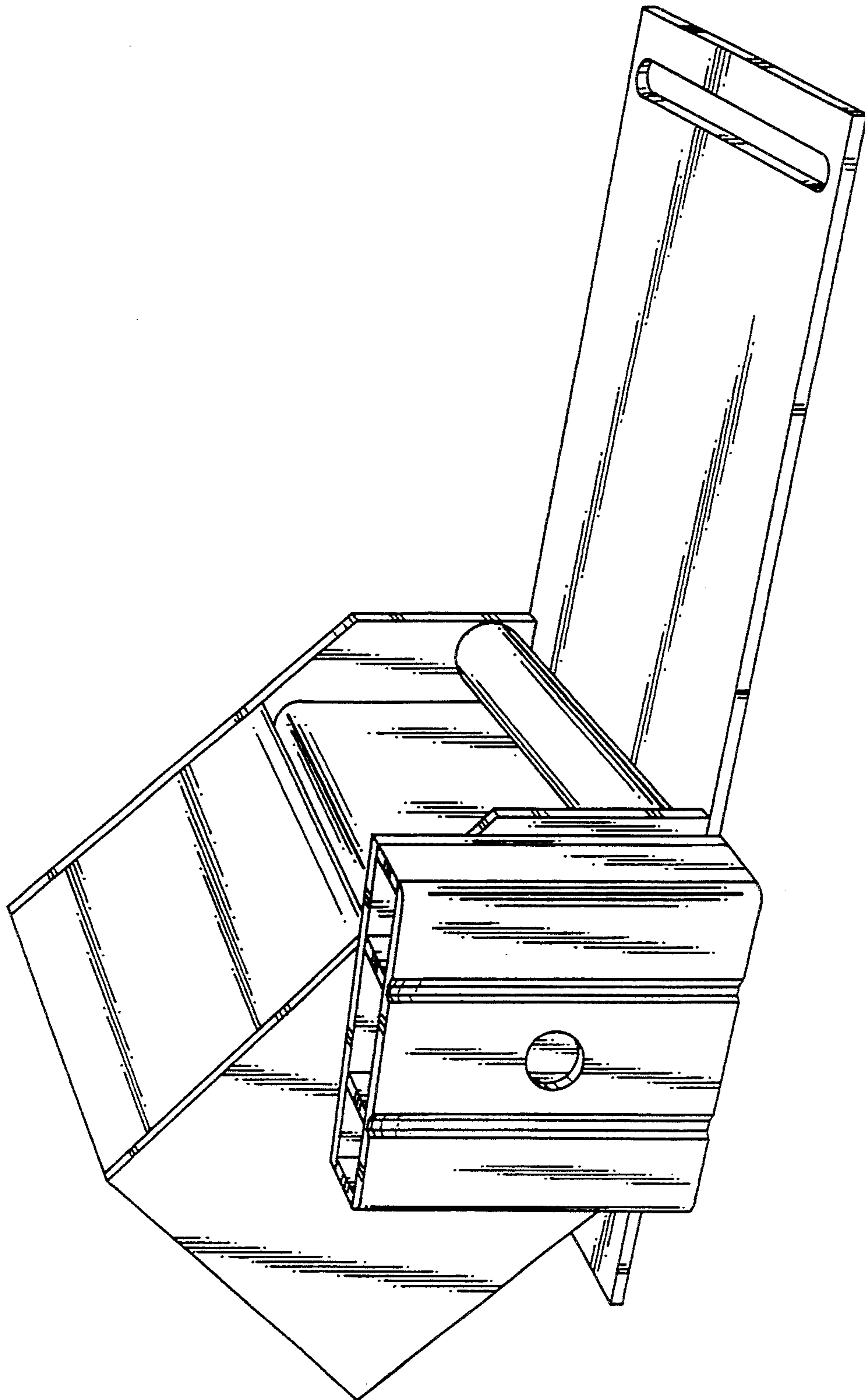

FIG. 1

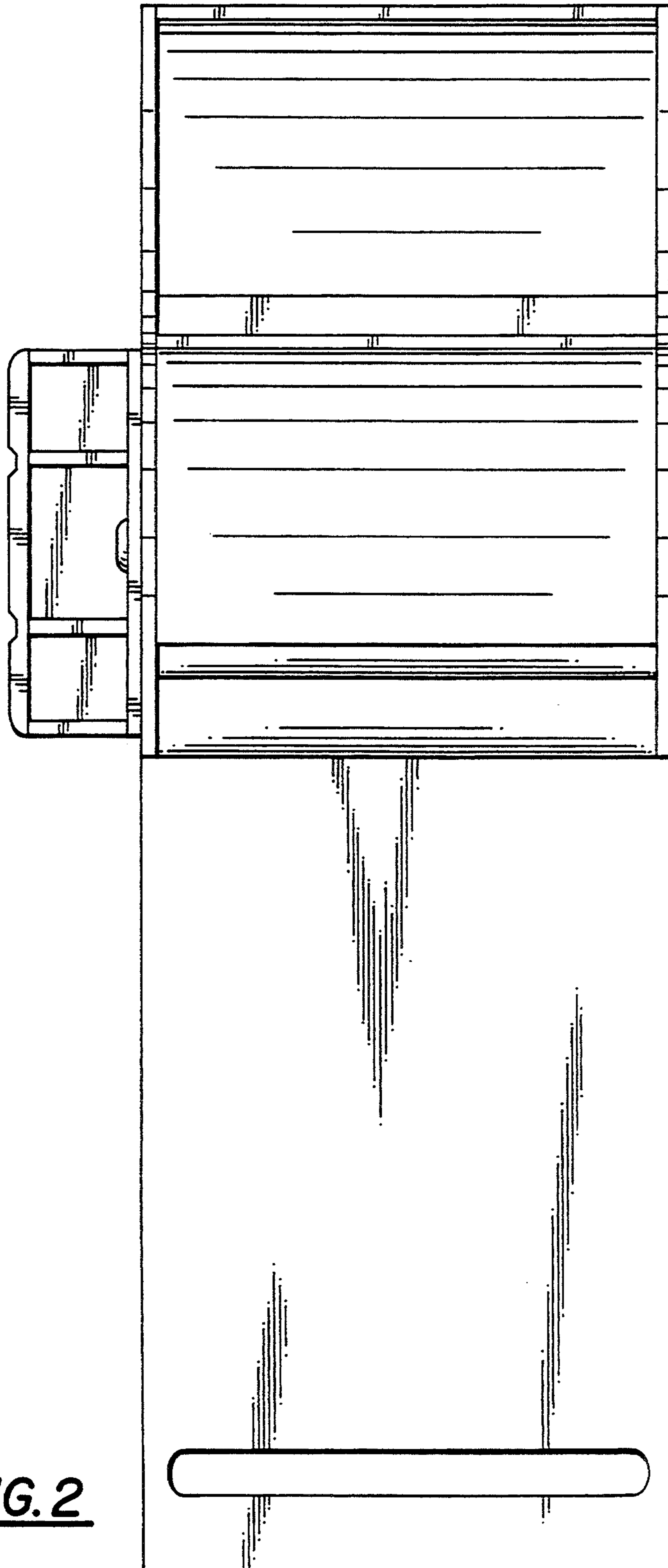

FIG. 2

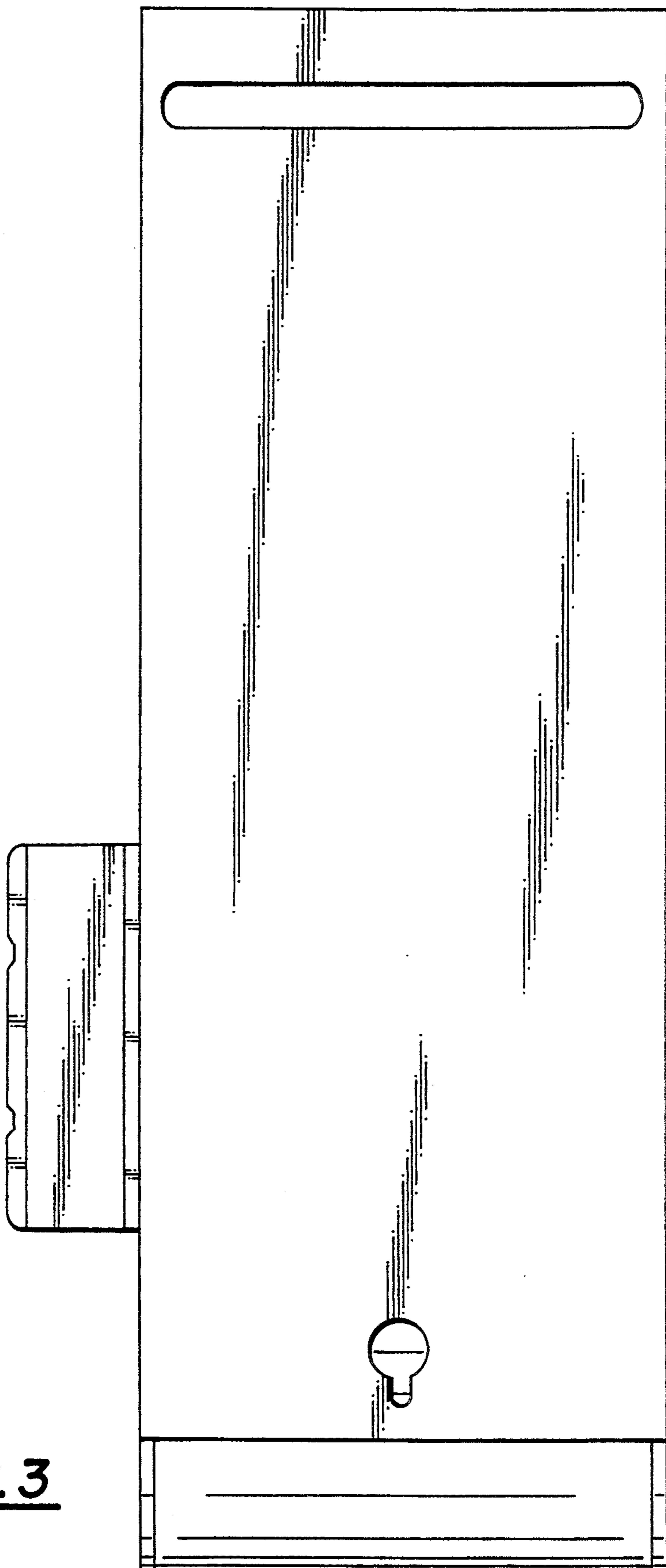

FIG. 3

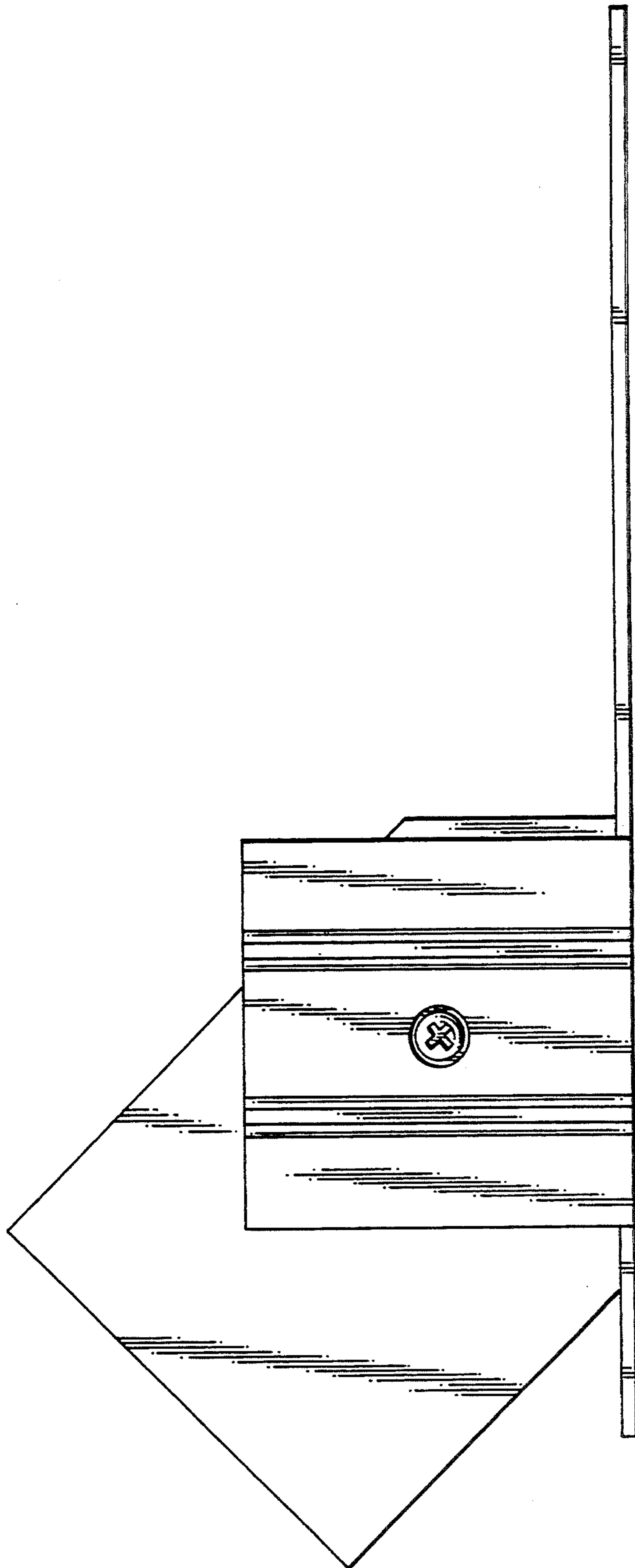

FIG. 4

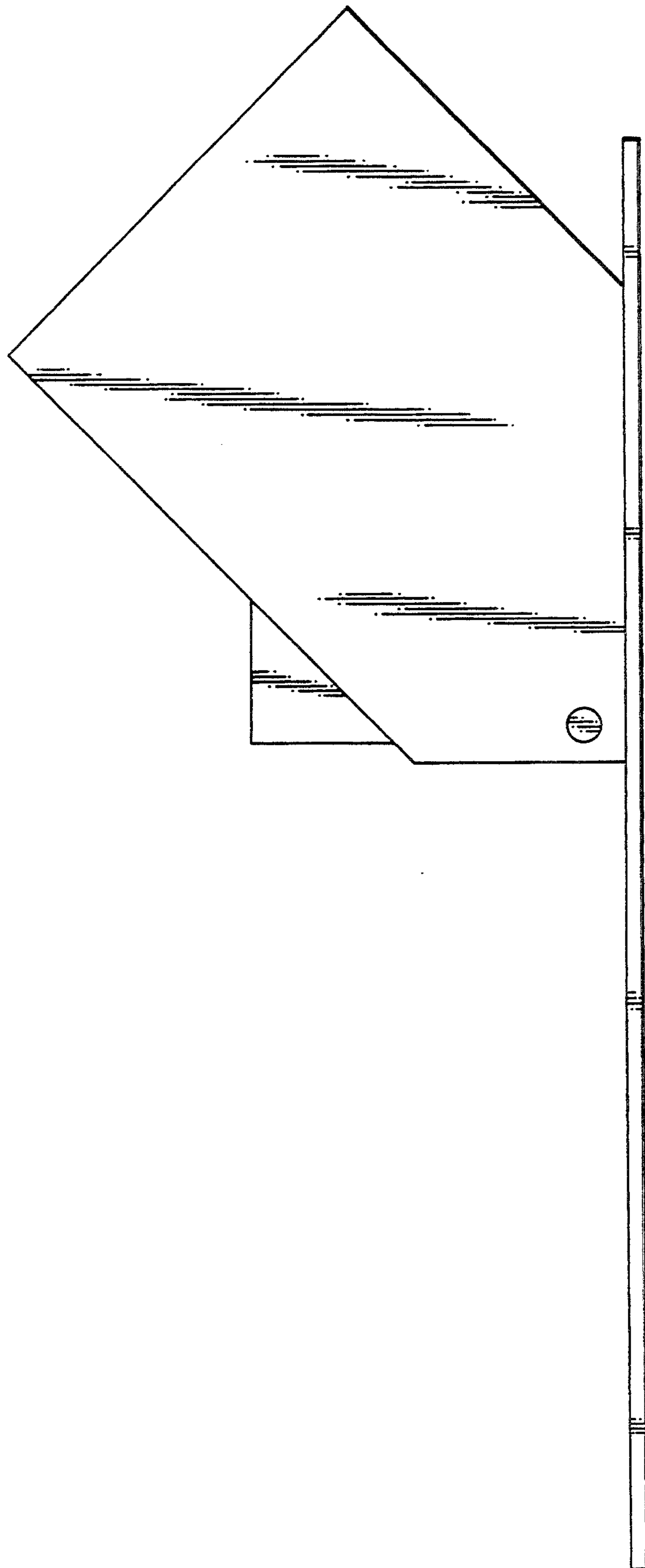

FIG. 5

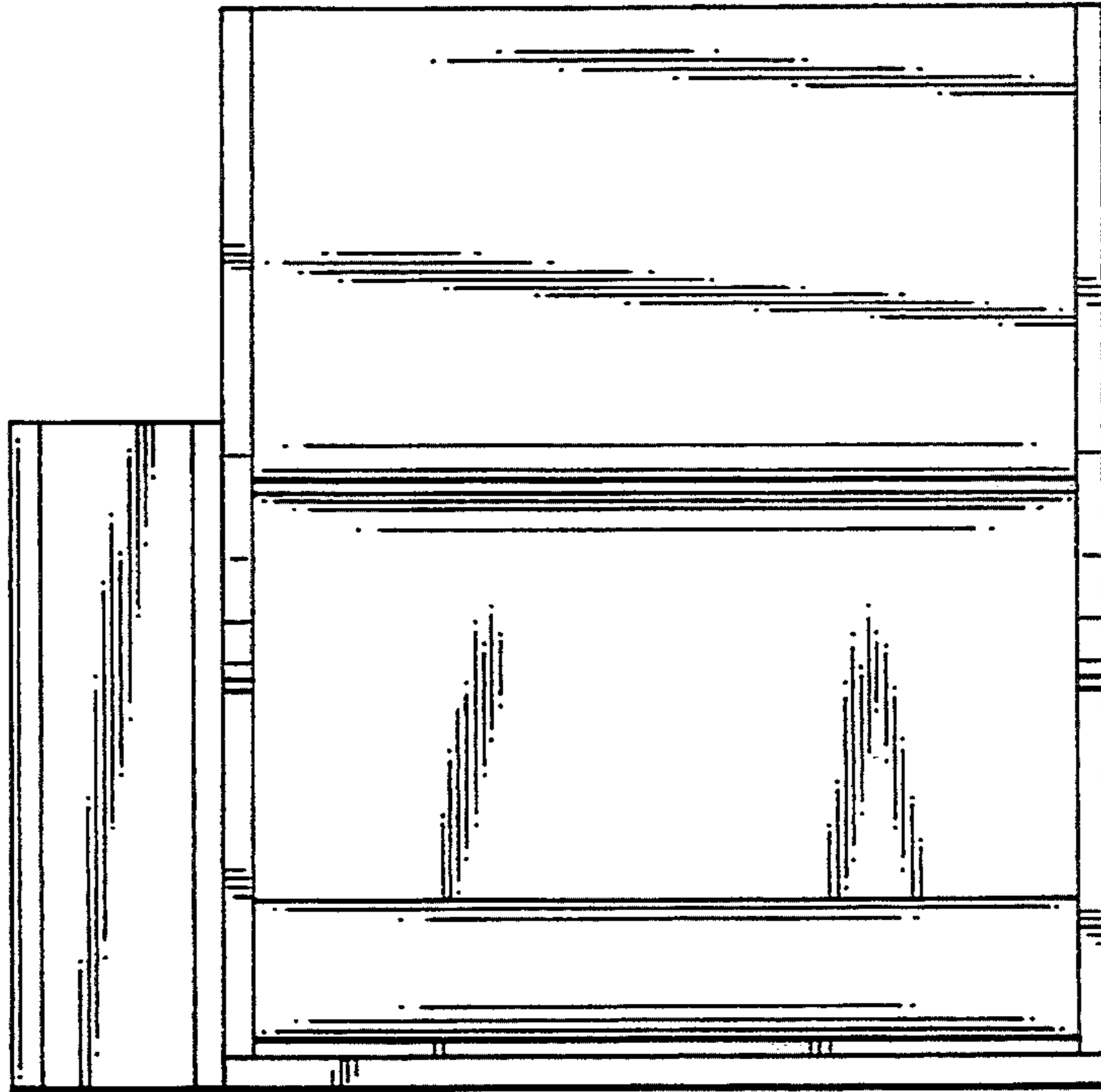

FIG. 6

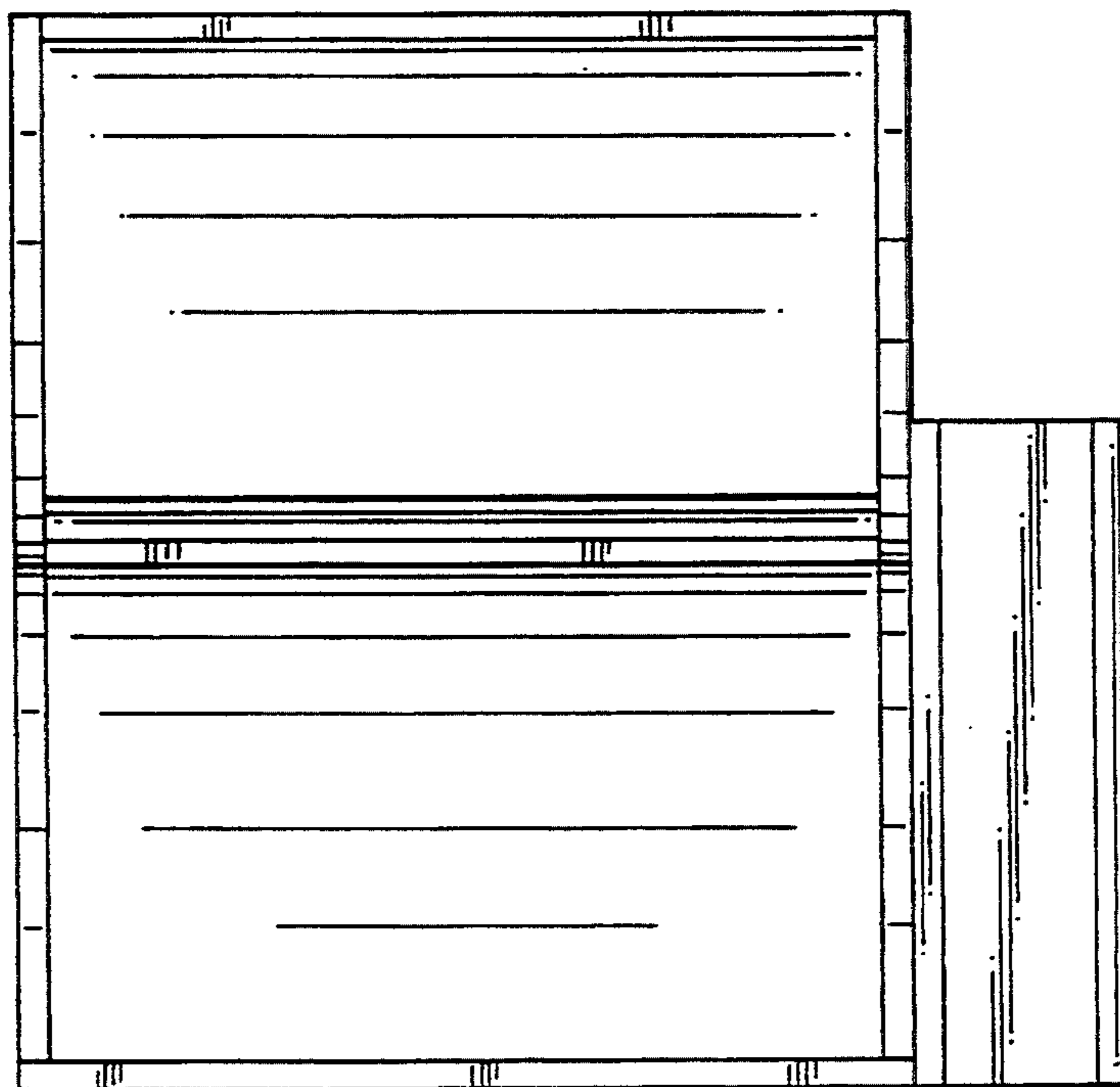

FIG. 7