



US00D361062S

# United States Patent [19]

[11] Patent Number: **Des. 361,062**

Iino et al.

[45] Date of Patent: **\*\* Aug. 8, 1995**

[54] **ELECTRONIC COMPUTER**

[75] Inventors: **Masaaki Iino**, Yokohama; **Ryoichi Ishiura**, Matsudo, both of Japan

[73] Assignee: **Kabushiki Kaisha Toshiba**, Kanagawa, Japan

8803411 12/1989 Germany .  
 8908516 7/1990 Germany .  
 9000539 7/1990 Germany .  
 9103652 2/1992 Germany .  
 9103696 2/1992 Germany .  
 9106802 3/1992 Germany .

(List continued on next page.)

[\*\*] Term: **14 Years**

[21] Appl. No.: **12,978**

[22] Filed: **Sep. 15, 1993**

### OTHER PUBLICATIONS

[30] **Foreign Application Priority Data**

Mar. 17, 1993 [JP] Japan ..... 5-7427

[52] **U.S. Cl.** ..... **D14/106**

[58] **Field of Search** ..... D14/100, 101, 106, 113, D14/115, 124-127; D18/1, 7, 11, 12, 2; 235/145 A, 145 R; 341/22, 23; 345/104, 156, 168, 173, 901  $\alpha$  905, 87; 361/679  $\alpha$  686; 364/708.1, 709.04, 709.12; 400/486, 489

Catalog, Compaq, "LTE Lite/25c" May 20, 1992.  
 Catalog, Everex "Carrier SL/25" Jun. 22, 1992.  
 Hewlett Packard Advertisement, May 18, 1984.  
 Data General One Advertisement, Sep. 28, 1984.  
 Tandy 200, Mar. 16, 1985.  
 Data General One, May 23, 1985.  
 Apple IIC, Dec. 1985.  
 Zenith, Z-181 Portable PC, Jun.-Jul. 1986.  
 Ricoh, MyRIPORT JP70D, Sep. 29, 1986.  
 Data General One, Oct. 3, 1986.  
 Data General One Model 2J, May 20, 1987.  
 B16LX, Aug. 31, 1987.

(List continued on next page.)

### [56] References Cited

#### U.S. PATENT DOCUMENTS

- D. 280,622 9/1985 Moggridge et al. .
- D. 283,511 4/1986 Dunn .
- D. 289,763 5/1987 Fujii et al. .
- D. 290,256 6/1987 Sapper .
- D. 293,678 1/1988 Sawatani et al. .
- D. 294,029 2/1988 Nishiyama et al. .
- D. 295,176 4/1988 Nishimoto et al. .
- D. 299,031 12/1988 Sugano .
- D. 303,250 9/1989 Ver Nooy et al. .
- D. 305,883 2/1990 Burton .
- D. 306,285 2/1990 Yu .
- D. 306,433 3/1990 Mitchell .
- D. 308,050 5/1990 Sugano et al. .
- D. 308,194 5/1990 Messerschmidt et al. .
- D. 308,860 6/1990 Tsukada et al. .
- D. 308,861 6/1990 Tsukada et al. .

(List continued on next page.)

#### FOREIGN PATENT DOCUMENTS

- 101093 7/1988 China .
- 8800660 10/1988 Germany .
- 8802901 5/1989 Germany .
- 8803410 12/1989 Germany .

*Primary Examiner*—Freda S. Nunn  
*Attorney, Agent, or Firm*—Banner, Birch, McKie & Beckett

### [57] CLAIM

The ornamental design for an electronic computer, as shown and described.

### DESCRIPTION

FIG. 1 is a top, front and right side perspective view of an electronic computer showing our new design;  
 FIG. 2 is a front elevational view thereof;  
 FIG. 3 is a left side elevational view thereof;  
 FIG. 4 is a right side elevational view thereof;  
 FIG. 5 is a rear elevational view thereof;  
 FIG. 6 is a top plan view thereof;  
 FIG. 7 is a bottom plan view thereof;  
 FIG. 8 is a front elevational view thereof in closed position;  
 FIG. 9 is a right side elevational view thereof in closed positioned; and,  
 FIG. 10 is a top plan view thereof in closed position.

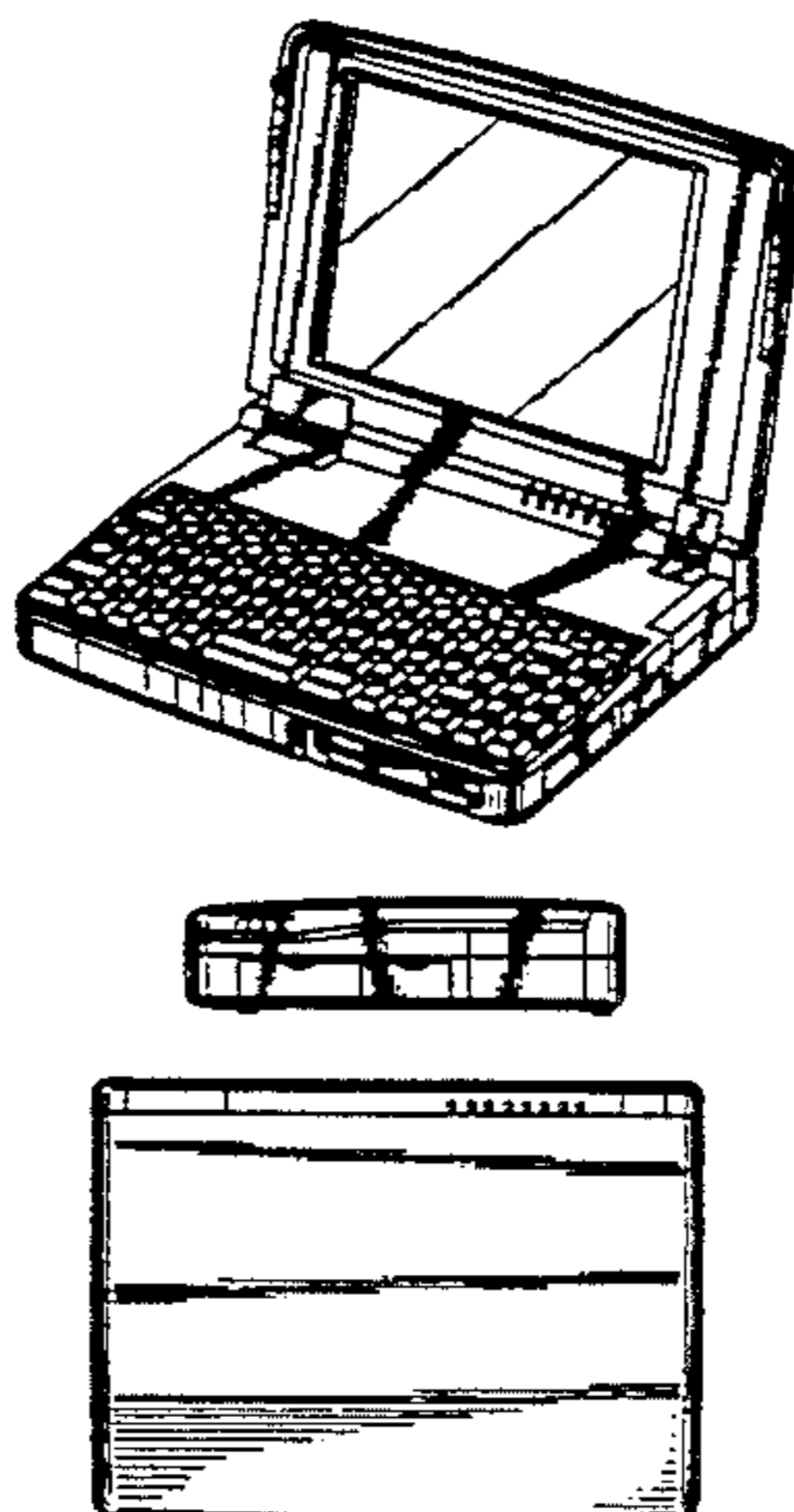

## U.S. PATENT DOCUMENTS

D. 310,353 9/1990 Sugano et al. .  
 D. 310,517 9/1990 Hara et al. .  
 D. 310,828 9/1990 Grundstrom et al. .  
 D. 311,527 10/1990 Fujii et al. .  
 D. 311,906 11/1990 Iino .  
 D. 312,249 11/1990 Sugano et al. .  
 D. 312,450 11/1990 Walters, II .  
 D. 312,822 12/1990 Watabe et al. .  
 D. 313,978 1/1991 Miyakuni .  
 D. 316,085 4/1991 Masaaki .  
 D. 317,442 6/1991 Gintz et al. .  
 D. 317,444 6/1991 Mizusugi et al. .  
 D. 319,819 9/1991 Kawaguchi .  
 D. 321,176 10/1991 Ma .  
 D. 322,780 1/1993 Iino et al. .  
 D. 324,038 2/1992 Izaki .  
 D. 324,674 3/1992 Iino .  
 D. 326,650 6/1992 Iino .  
 D. 327,473 6/1992 Iino .  
 D. 328,287 7/1992 Iino .  
 D. 328,455 8/1992 Izaki .  
 D. 331,393 12/1992 Iino .  
 D. 333,128 2/1993 Peng et al. .  
 D. 335,287 5/1993 Iino .  
 D. 336,076 6/1993 Masaaki .  
 D. 336,286 6/1993 Iino .  
 D. 336,465 6/1993 Kim .  
 D. 337,096 7/1993 Iino .  
 D. 337,100 7/1993 Iino .  
 D. 337,319 7/1993 Iino .  
 D. 338,660 8/1993 Youens et al. .  
 D. 338,879 8/1993 Iino .  
 D. 346,369 4/1994 Iino ..... D14/106  
 D. 349,106 7/1994 Iino et al. .... D14/106  
 D. 350,121 8/1994 Kaneko ..... D14/106

## FOREIGN PATENT DOCUMENTS

9207240 2/1993 Germany .  
 639216 11/1984 Japan .  
 650470 5/1985 Japan .  
 685063 8/1986 Japan .  
 685121 8/1986 Japan .  
 686658 9/1986 Japan .  
 68512(1) 10/1988 Japan .  
 746985(2) 4/1989 Japan .  
 746985(1) 4/1989 Japan .  
 763838 6/1989 Japan .  
 763840 6/1989 Japan .  
 763855 6/1989 Japan .  
 761927(2) 5/1990 Japan .  
 761927(4) 6/1990 Japan .  
 67297 2/1987 Rep. of Korea .

92859 7/1988 Rep. of Korea .  
 85032 10/1988 Rep. of Korea .  
 94470 9/1989 Rep. of Korea .  
 100917 4/1990 Rep. of Korea .  
 113906 5/1991 Rep. of Korea .  
 115245 6/1991 Rep. of Korea .  
 115673 7/1991 Rep. of Korea .  
 115780 7/1991 Rep. of Korea .  
 115781 7/1991 Rep. of Korea .  
 115787 7/1991 Rep. of Korea .  
 119238 10/1991 Rep. of Korea .  
 122562 1/1992 Rep. of Korea .  
 115673 5/1992 Rep. of Korea .  
 130595 9/1992 Rep. of Korea .  
 149344 1/1991 Taiwan .

## OTHER PUBLICATIONS

Ricoh brochure, Sep. 17, 1987.  
 Panasonic U1EX, Oct. 2, 1987.  
 Nihon IBM 55 Model 5535, Oct. 19, 1987.  
 NEC Minitel 5 Advertisement, Oct. 29, 1987.  
 Rein, Laptop 300 SLC, Oct. 29, 1987.  
 NEC PC-9800 Advertisement, Nov. 27, 1987.  
 Schneider Multivision 300SLC Catalog, 1988.  
 Laptop computer HALIKAN LA-22, LA-30, Apr. 21, 1988.  
 WS Japanese Advertisement, NEC MultiSpeed EL, Apr. 27, 1988.  
 NEC MultiSpeed EL model, May 10, 1988.  
 NEC PC-9801LV21, May 13, 1988.  
 Sharp WV-500, May 19, 1988.  
 NEC PC-98LT Jul. 14, 1988.  
 NEC PC-9801LX5C, Aug. 23, 1988.  
 Sharp AX286L, Sep. 29, 1988.  
 Ricoh, Magus, Feb. 1, 1990.  
 Mitsubishi Maxy, May 15, 1990.  
 Samsung NoteMaster 386S/16, Nov. 12, 1990.  
 Super-NB386S, Nov. 12, 1990.  
 52NOTE, May 15, 1991.  
 Premium Exec 386SX120, Jun. 1, 1991.  
 Goldstar GS620 386SX Jun. 1, 1991.  
 Mobile Office, MastersPort 386SL, Jun. 1, 1991.  
 Mitsubishi mp386L Jun. 1, 1991.  
 NERO/DXS, Jul./Aug. 1987.  
 Sharp AX286N-H2 May 18, 1990.  
 The Book, Oct. 24, 1989.  
 BriteLite IPX, Daisin Electric, Feb. 19, 1992.  
 Everex Temp LX, Jun. 22, 1989.  
 Altima 400 Series, Jun. 22, 1992.  
 Nikon Kogyo Shinbun, BriteLite IPX, Mar. 5, 1992.



FIG. 1

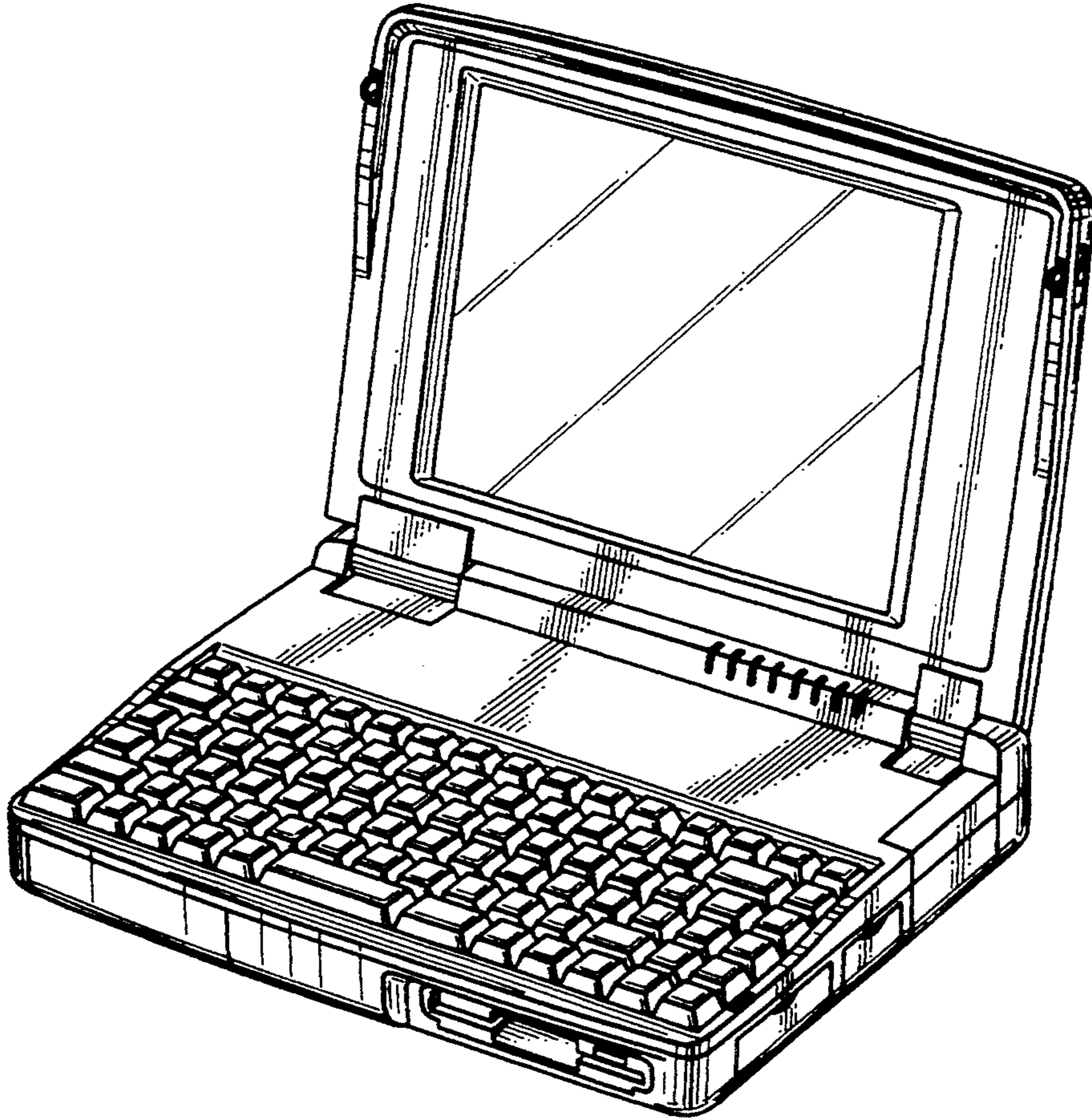

FIG. 2

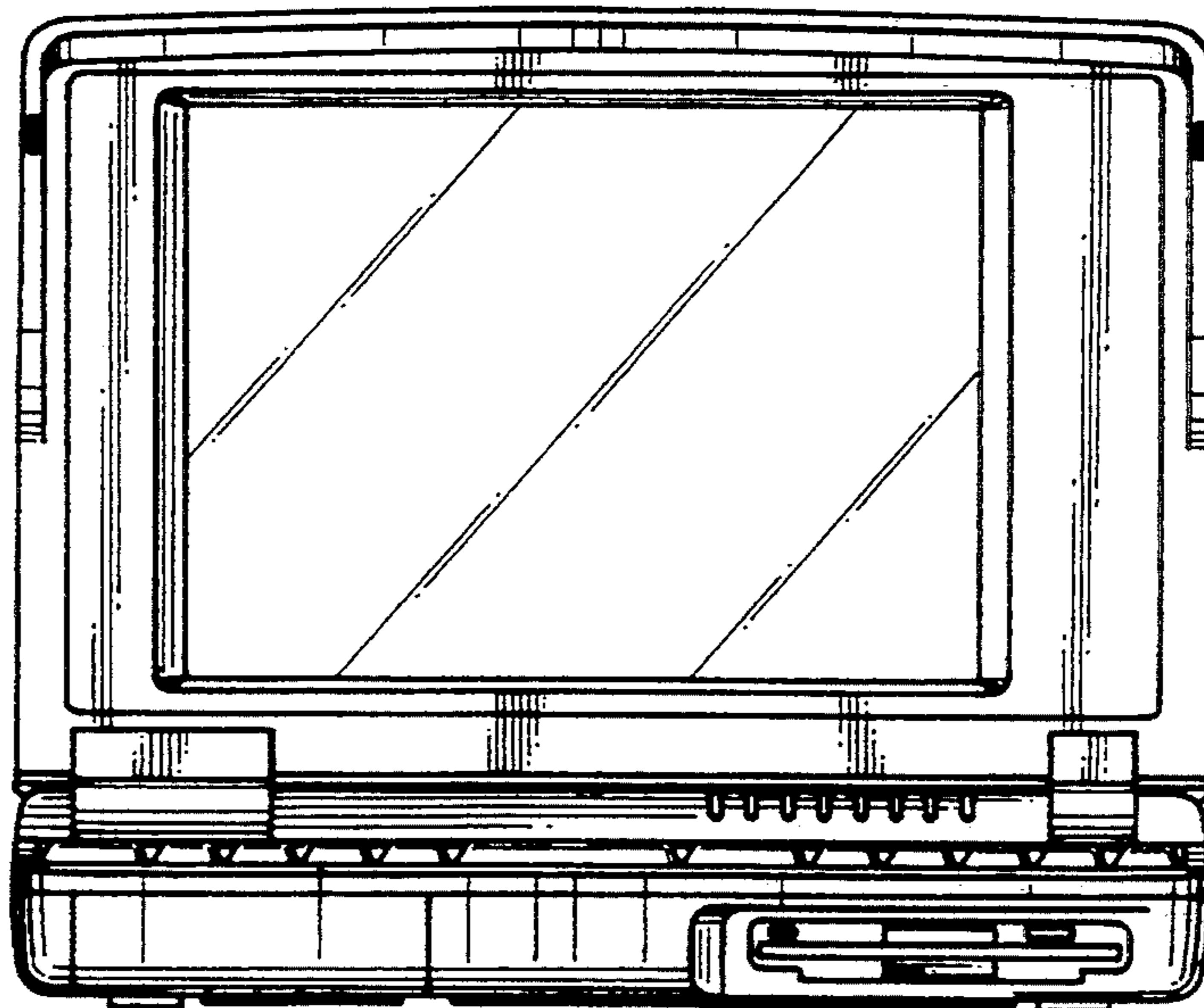

FIG.3

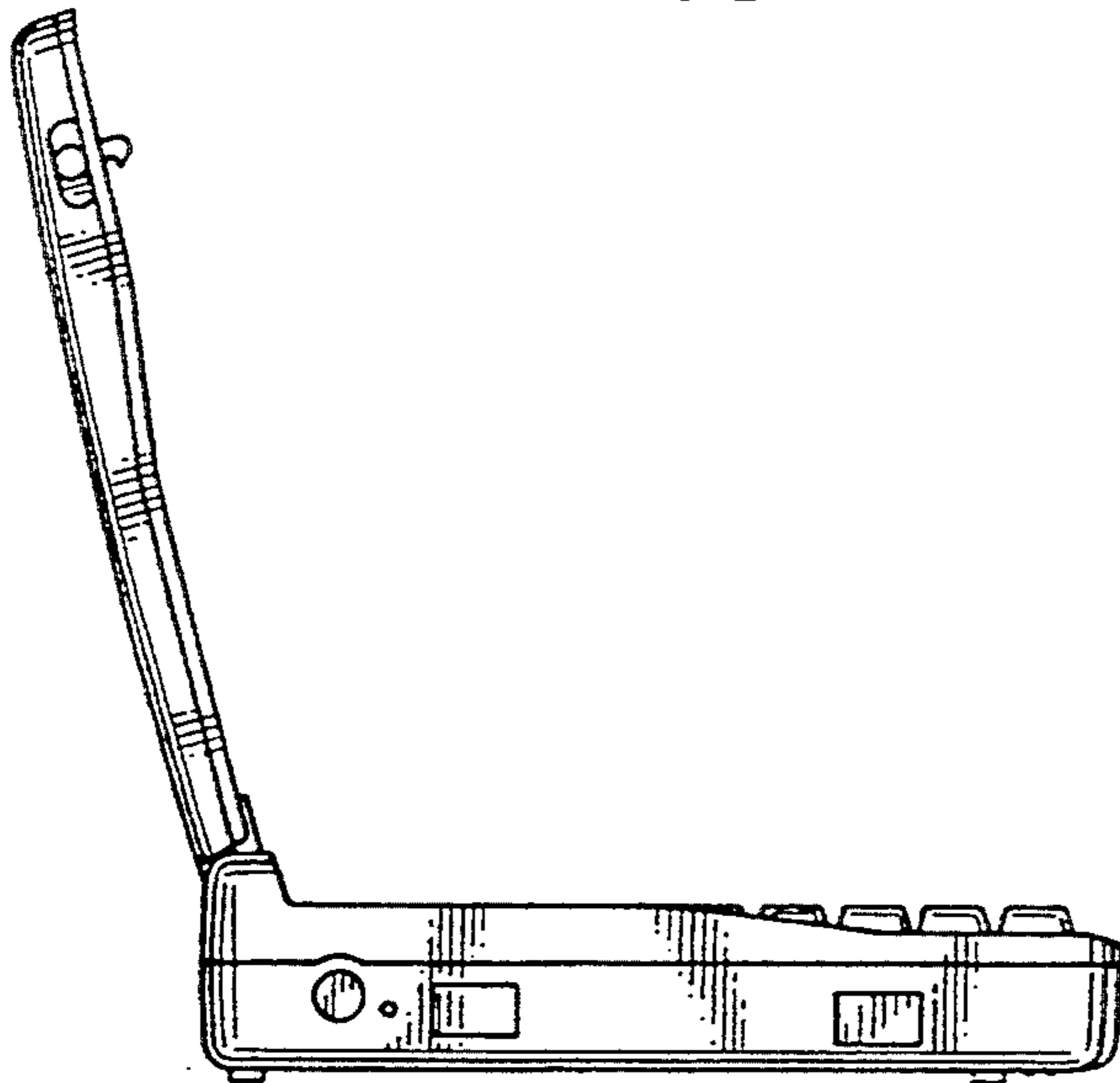

FIG.4

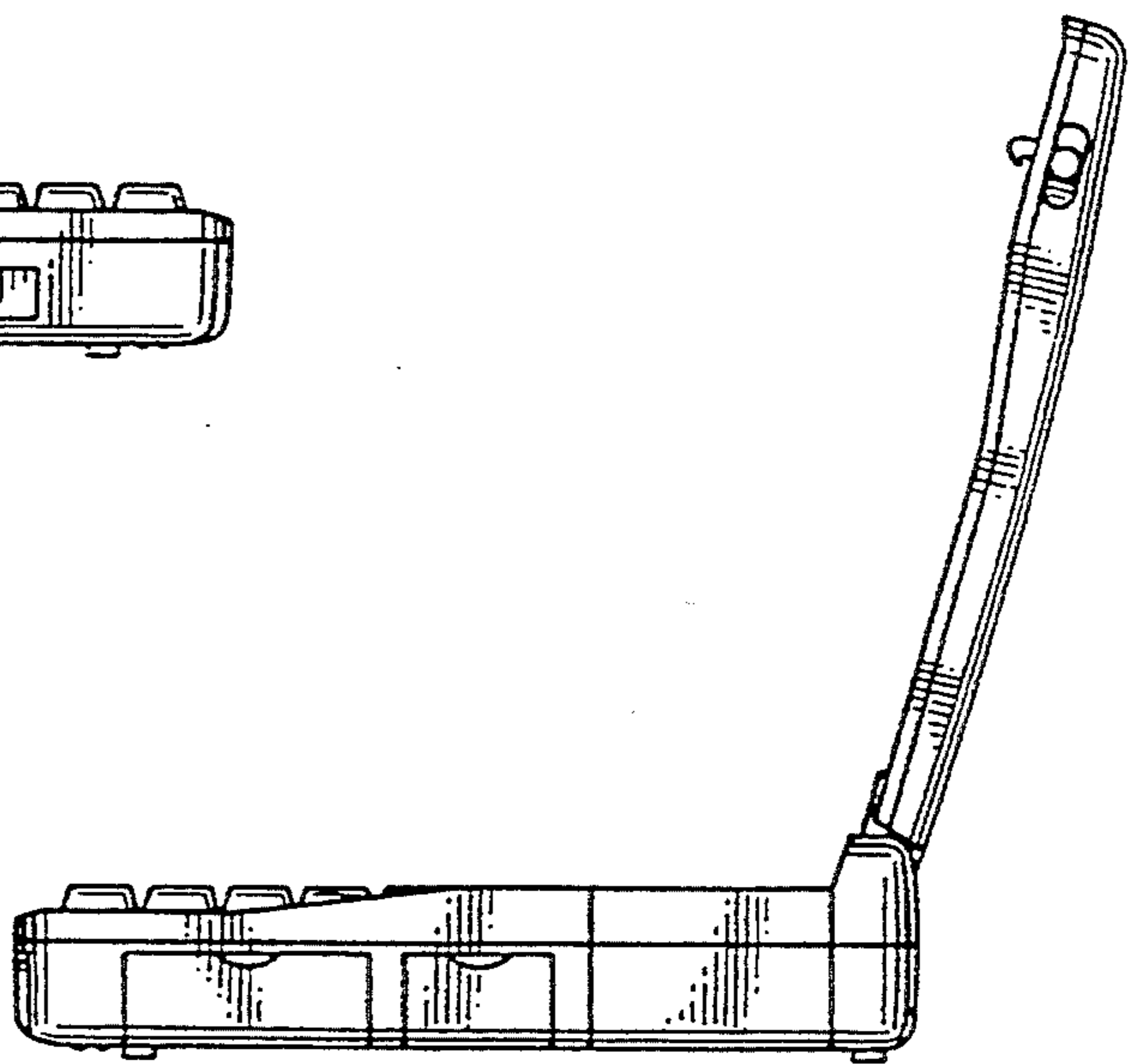

FIG.5

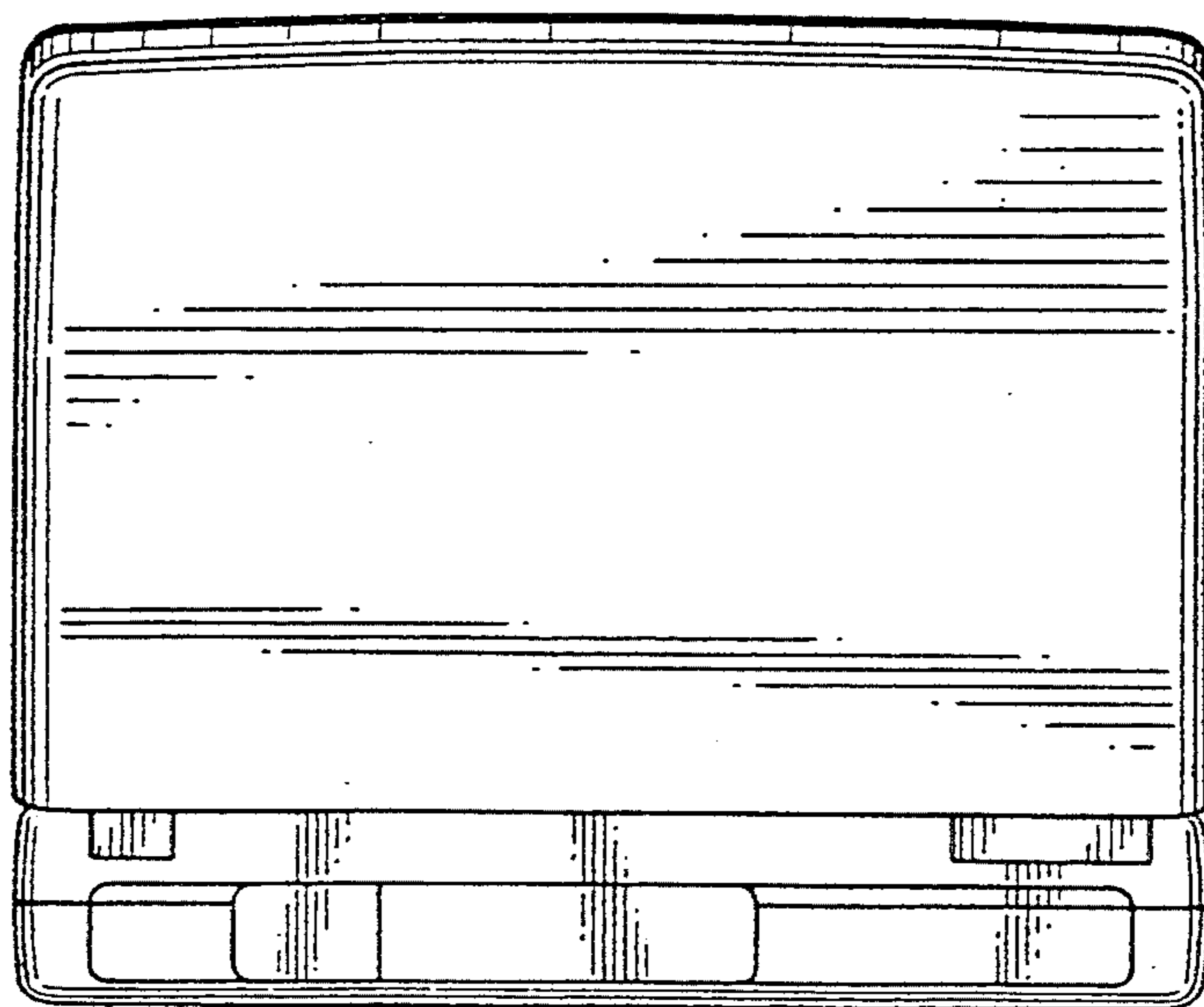

FIG. 6

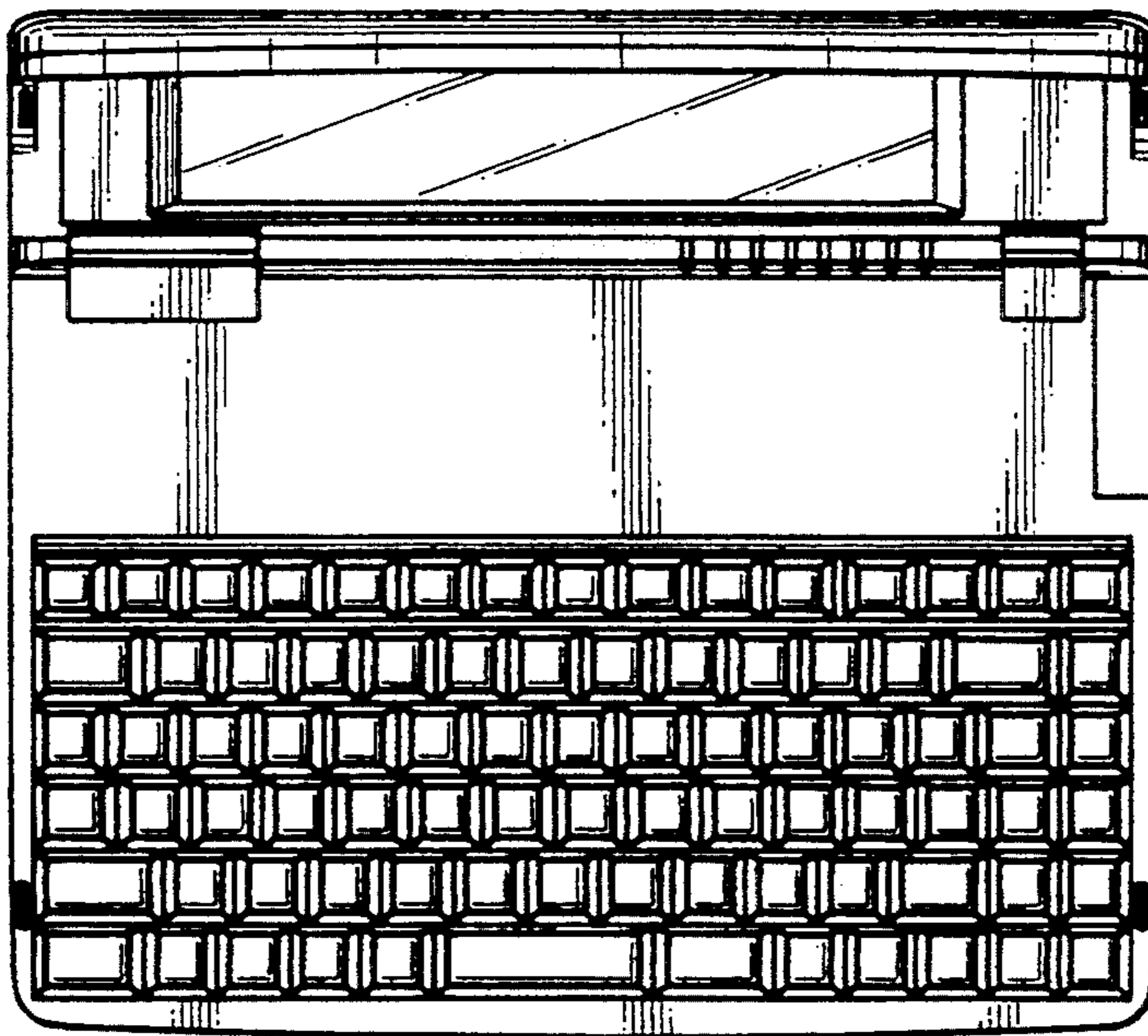

FIG. 7

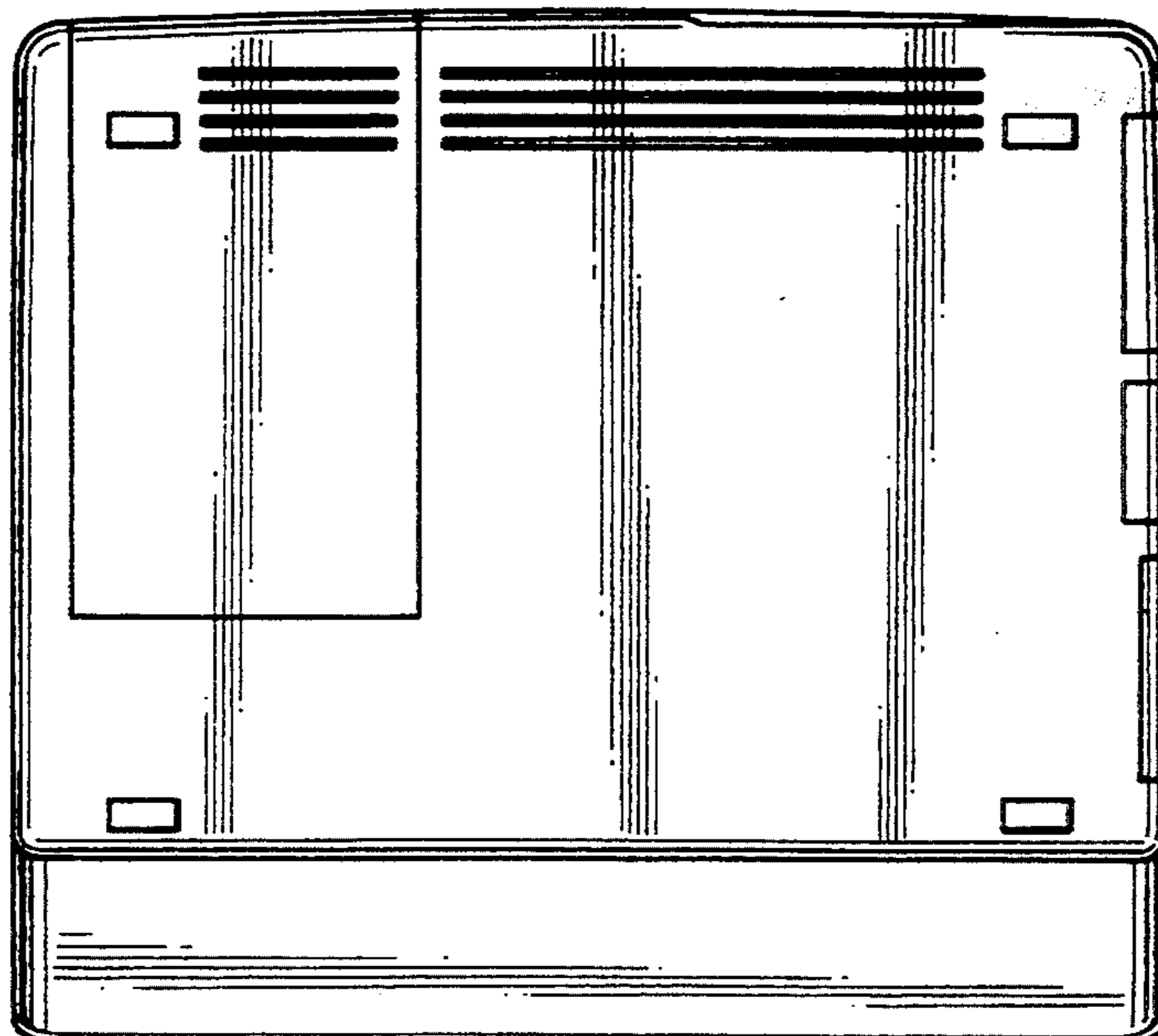

FIG.8

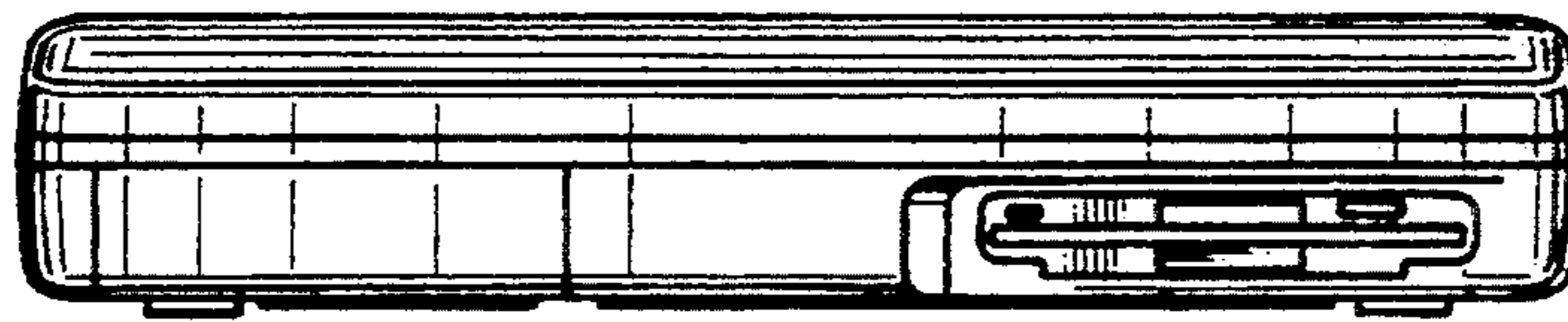

FIG.9

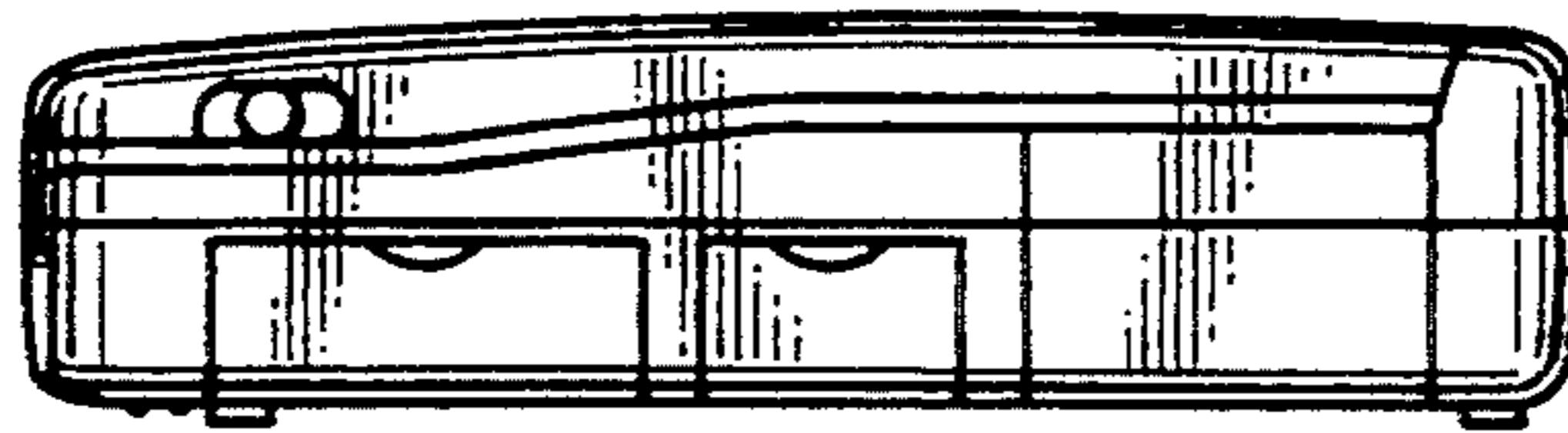

FIG.10

