



US00D361014S

United States Patent [19]

[11] Patent Number: **Des. 361,014**

Baribeau

[45] Date of Patent: **** Aug. 8, 1995**

[54] **CANOPY FOR USE ON AN OUTDOOR GRILL**

[76] Inventor: **Joseph L. Baribeau**, 96 Hope St., Niantic, Conn. 06357

[**] Term: **14 Years**

[21] Appl. No.: **14,307**

[22] Filed: **Oct. 20, 1993**

[52] U.S. Cl. **D7/402**

[58] Field of Search **D7/402; D25/56; D12/133; D6/491, 333; 297/184.1, 184.11, 184.13, 184.15, 184.16; 248/345; 135/101, 117, 87, 90, 105**

[56] **References Cited**

U.S. PATENT DOCUMENTS

D. 124,429	12/1940	Kroll et al.	D12/133
D. 160,043	9/1950	Watson	D25/56
D. 168,062	10/1952	Moore	D25/56
D. 312,931	12/1990	Westfall et al.	D12/133

D. 335,046	4/1993	Diaz	D6/491
4,639,036	1/1987	Nichols .	
4,768,317	9/1988	Markham	135/117
5,033,528	7/1991	Volcani .	
5,067,770	11/1991	Hassell, Jr.	297/184.13

Primary Examiner—Ruth McInroy
Attorney, Agent, or Firm—Terry M. Gernstein

[57] **CLAIM**

The ornamental design for a canopy for use on an outdoor grill, as shown and described.

DESCRIPTION

FIG. 1 is a front, top and side perspective view of a canopy for use on an outdoor grill showing my new design;
FIG. 2 is a front elevational view thereof;
FIG. 3 is a rear elevational view thereof;
FIG. 4 is a side elevational view thereof, the side opposite being a mirror image of the side shown in FIG. 4;
FIG. 5 is a top plan view thereof; and,
FIG. 6 is a bottom plan view thereof.

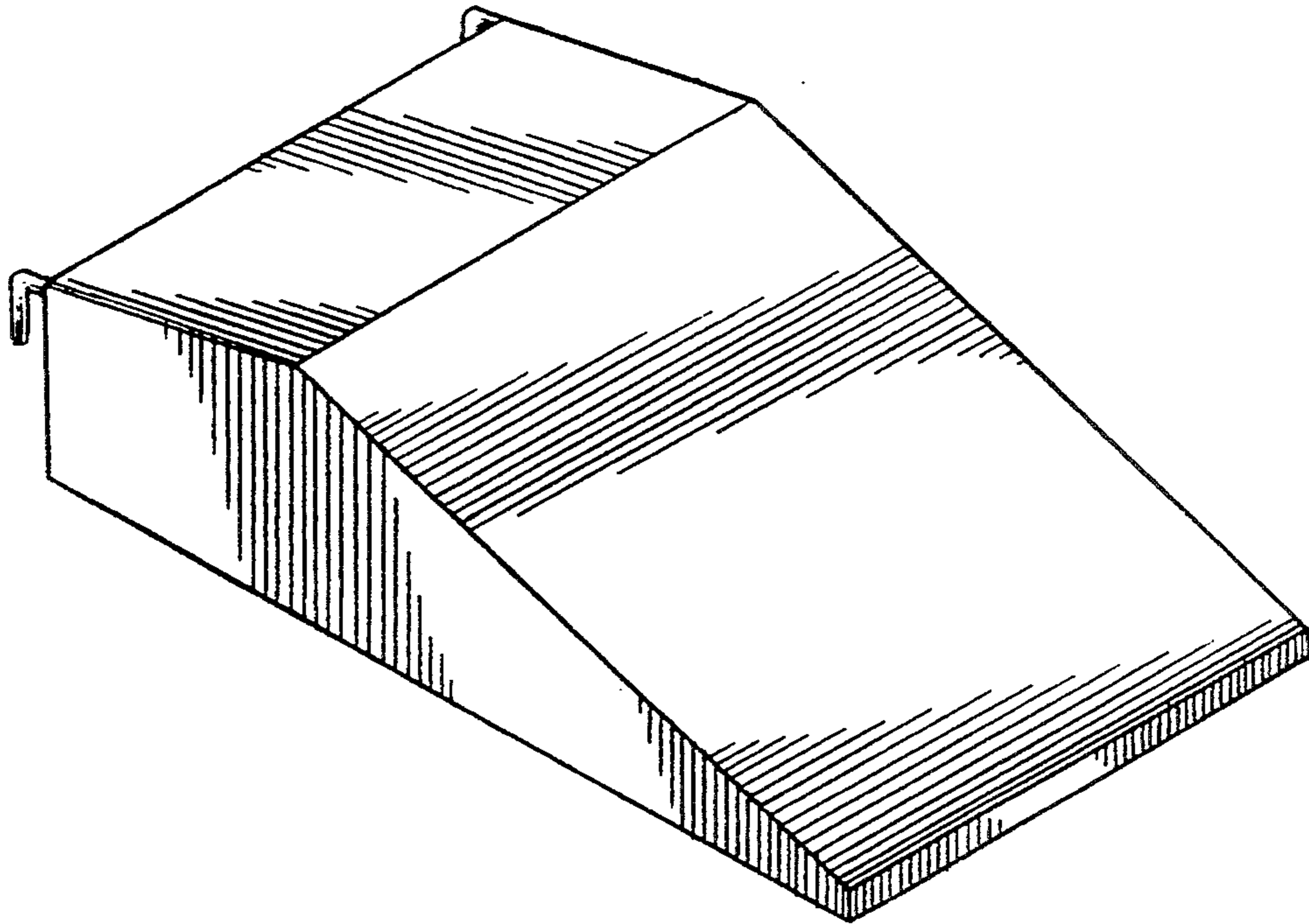

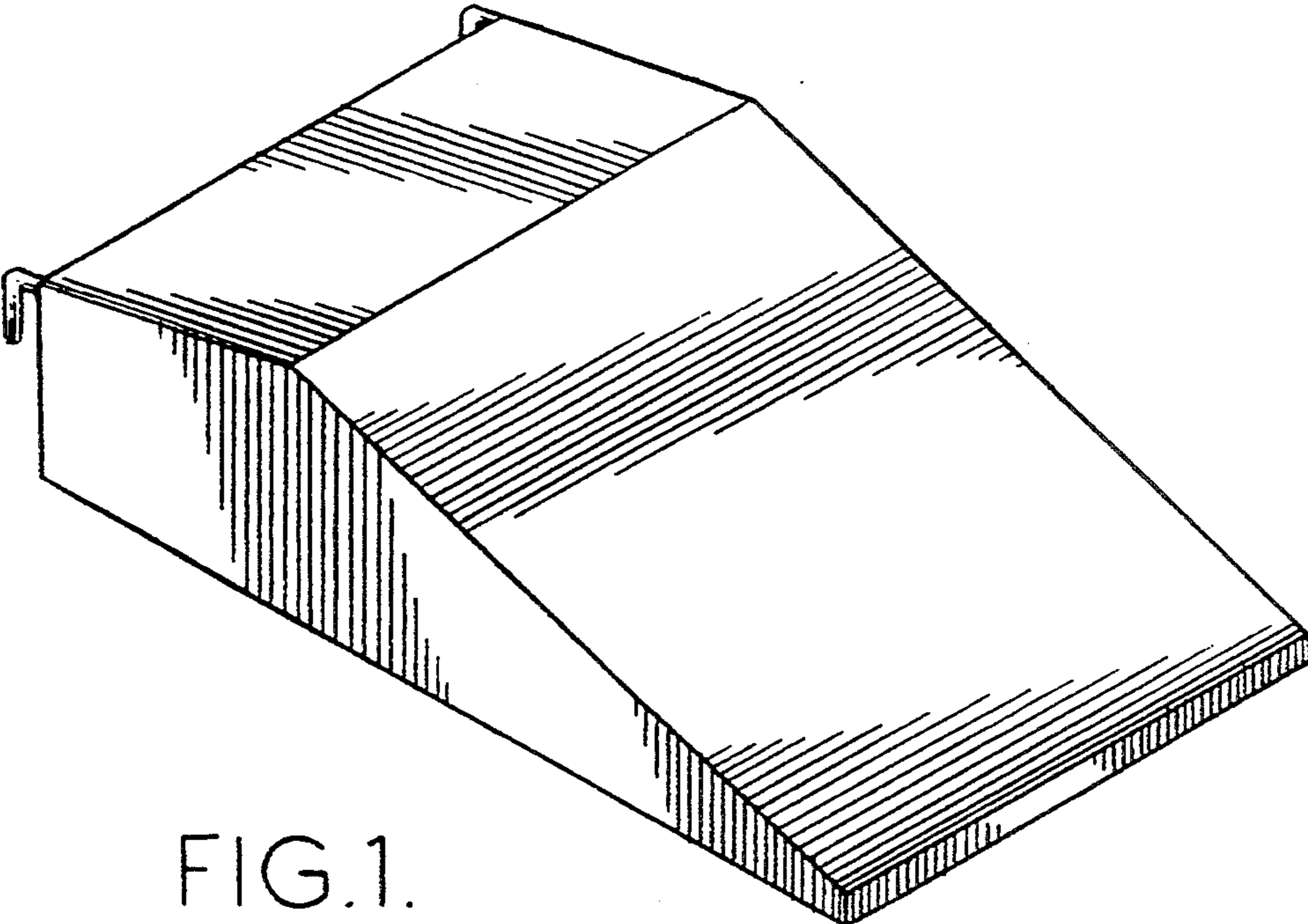

FIG. 1.

FIG. 6.

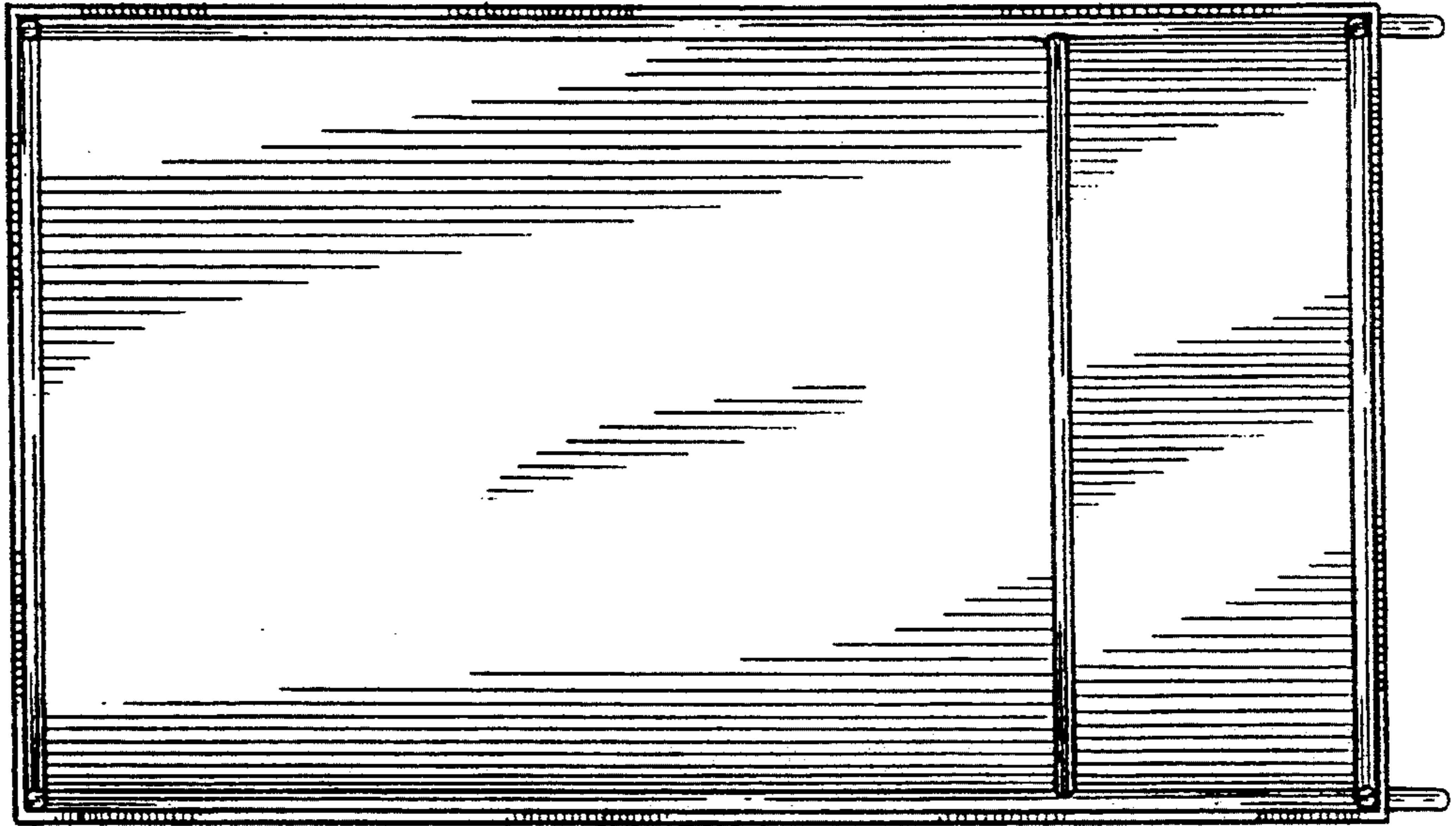

FIG. 2.

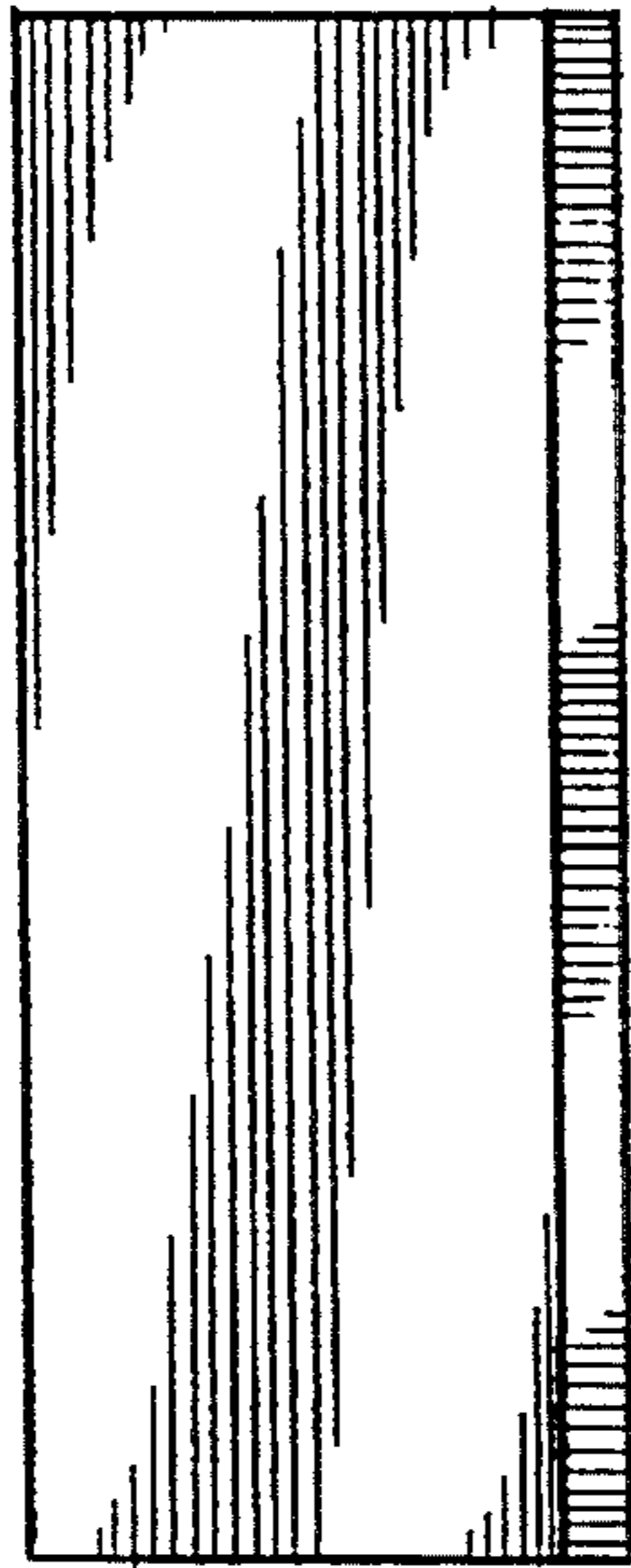
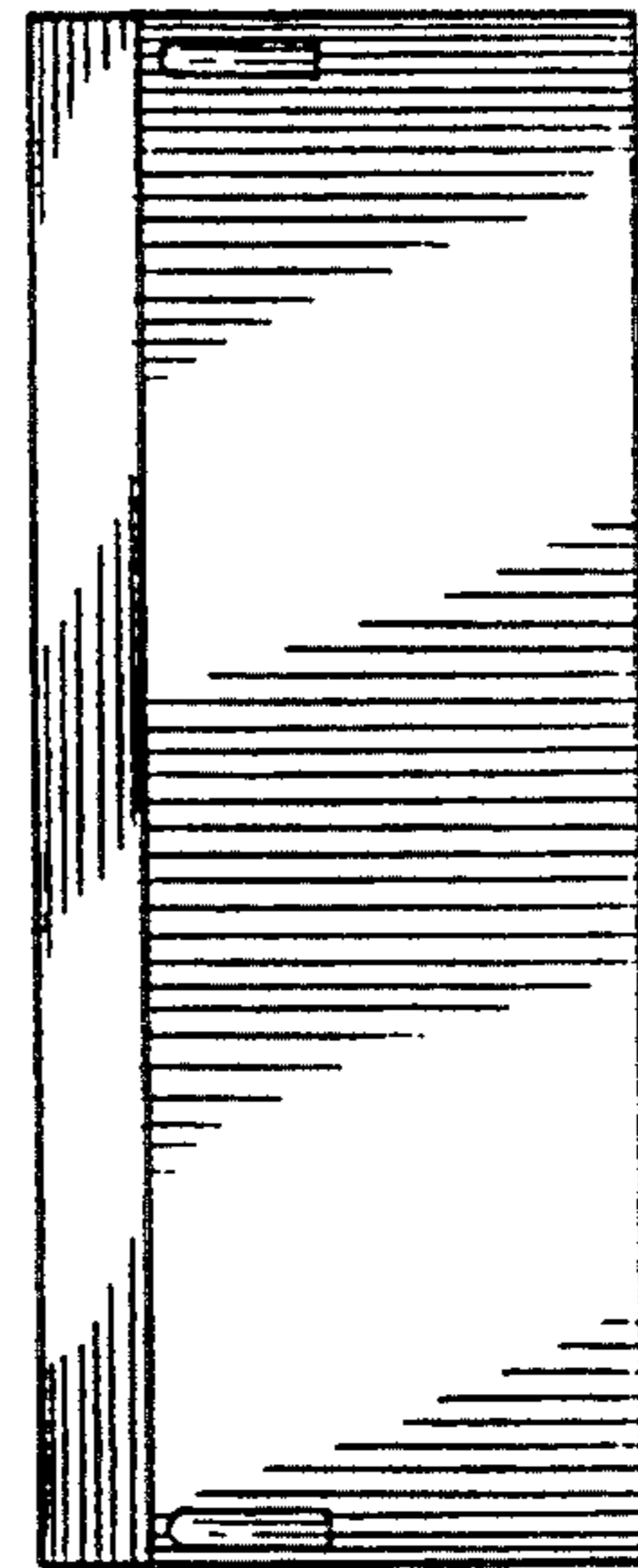

FIG. 3.



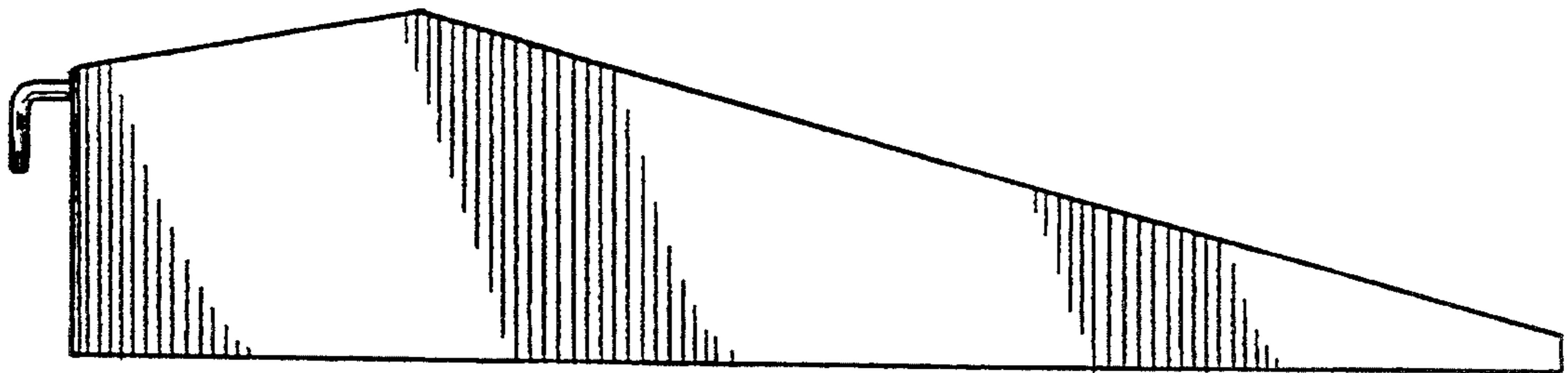

FIG. 4.

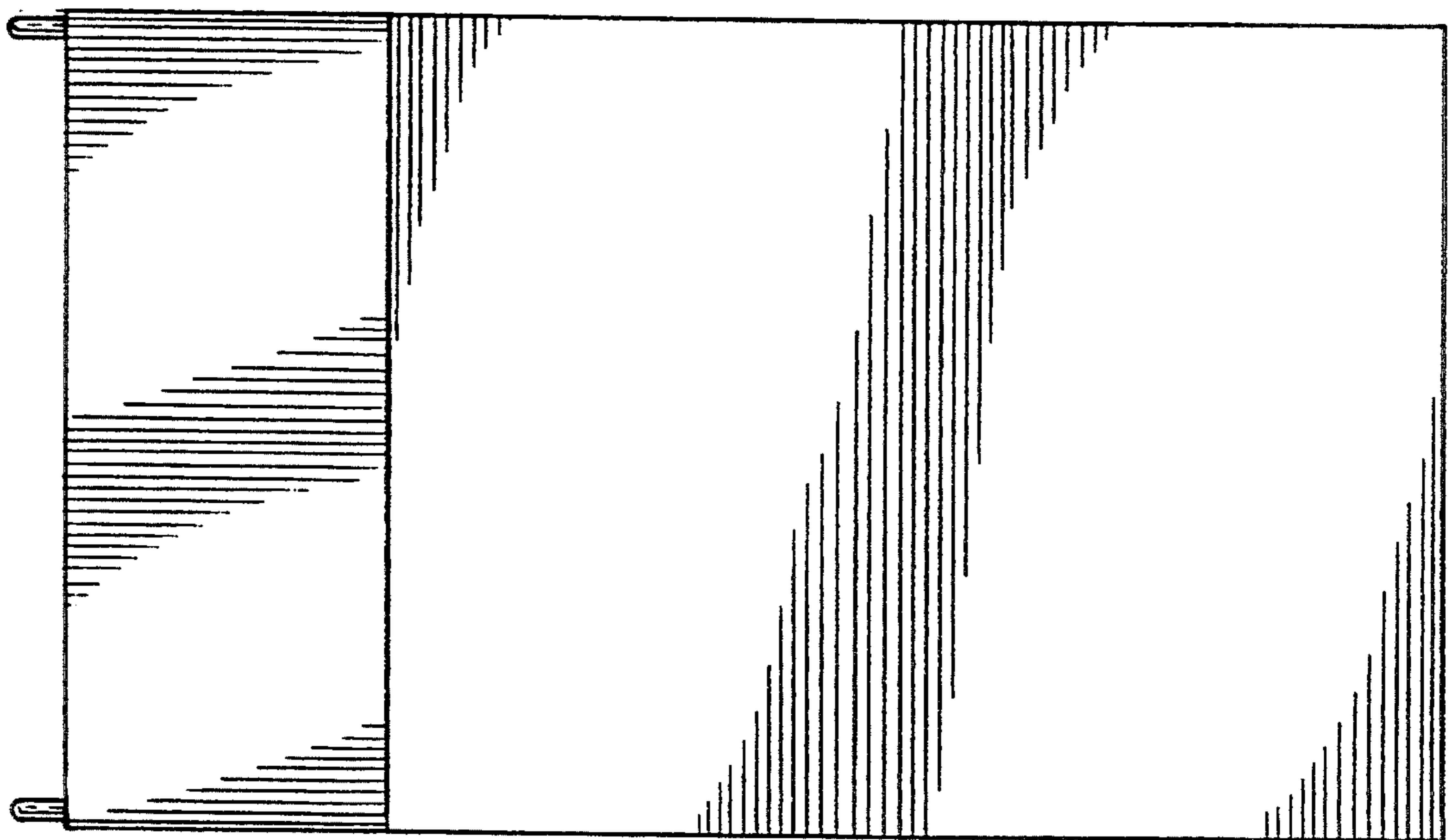

FIG. 5.