



US00D360982S

United States Patent [19]

[11] Patent Number: **Des. 360,982**

Coffman

[45] Date of Patent: **** Aug. 8, 1995**

[54] **BATH BRUSH**

[76] Inventor: **Paul D. Coffman**, 106 Polk St., Box 9, Sheldahl, Iowa 50243

[**] Term: **14 Years**

[21] Appl. No.: **7,677**

[22] Filed: **Apr. 30, 1993**

[52] U.S. Cl. **D4/102; D4/134; D28/63**

[58] Field of Search **D4/100-102, D4/109, 121, 132, 134, 138; D28/63; D24/211, 214-215; 15/21.1, 22.1, 22.2, 23, 25-28, 143.1, 145, 159.1, 160; 601/84, 103, 109, 112, 114, 136-137**

[56] **References Cited**

U.S. PATENT DOCUMENTS

2,778,043	1/1957	Arf	15/28
3,775,800	12/1973	Veneziani	15/28
4,508,108	4/1985	Miyaoko	15/145 X
5,187,827	2/1993	Wei	15/22.1

Primary Examiner—A. Hugo Word
Assistant Examiner—Lavone D. Tabor
Attorney, Agent, or Firm—David L. Baker; Rhodes & Ascolillo

[57] **CLAIM**

The ornamental design for a bath brush, as shown and described.

DESCRIPTION

FIG. 1 is a front elevational view of the first embodiment of a bath brush showing my new design;
FIG. 2 is a left side elevational view of FIG. 1;

FIG. 3 is a front elevational view of the second embodiment of the bath brush;
FIG. 4 is a left side elevational view of FIG. 3;
FIG. 5 is an enlarged perspective view of the housing of the bath brush which is common to both embodiments and shown separately for clarity illustration only;
FIG. 6 is a rear elevational view of FIG. 5;
FIG. 7 is a bottom plan view of FIG. 5;
FIG. 8 is a top plan view of FIG. 5;
FIG. 9 is a right side elevational view of FIG. 5;
FIG. 10 is a front elevational view of FIG. 5;
FIG. 11 is a left side elevational view of FIG. 5;
FIG. 12 is an enlarged perspective view of the brush head of the second embodiment, shown separately for clarity of illustration only;
FIG. 13 is a top plan view of FIG. 12;
FIG. 14 is a bottom plan view of FIG. 12;
FIG. 15 is a front elevational view of FIG. 12;
FIG. 16 is a left side elevational view of FIG. 12, the right side being a mirror image thereof;
FIG. 17 is a rear elevational of FIG. 12;
FIG. 18 is an enlarged perspective view of the brush head of the first embodiment, shown separately for clarity of illustration only;
FIG. 19 is a top plan view of FIG. 18;
FIG. 20 is a bottom plan view of FIG. 18;
FIG. 21 is a front elevational view of FIG. 18;
FIG. 22 is a left side elevational view of FIG. 18, the right side being a mirror image thereof;
FIG. 23 is a rear elevational view of FIG. 18;
FIG. 24 is a top plan view of the handle of the bath brush which is common to both embodiments and shown separately for clarity of illustration only;
FIG. 25 is a right side elevational view of FIG. 24;
FIG. 26 is a left side elevational view of FIG. 24;
FIG. 27 is a front elevational view of FIG. 24;
FIG. 28 is a rear elevational view of FIG. 24; and,
FIG. 29 is a bottom plan view of FIG. 24.

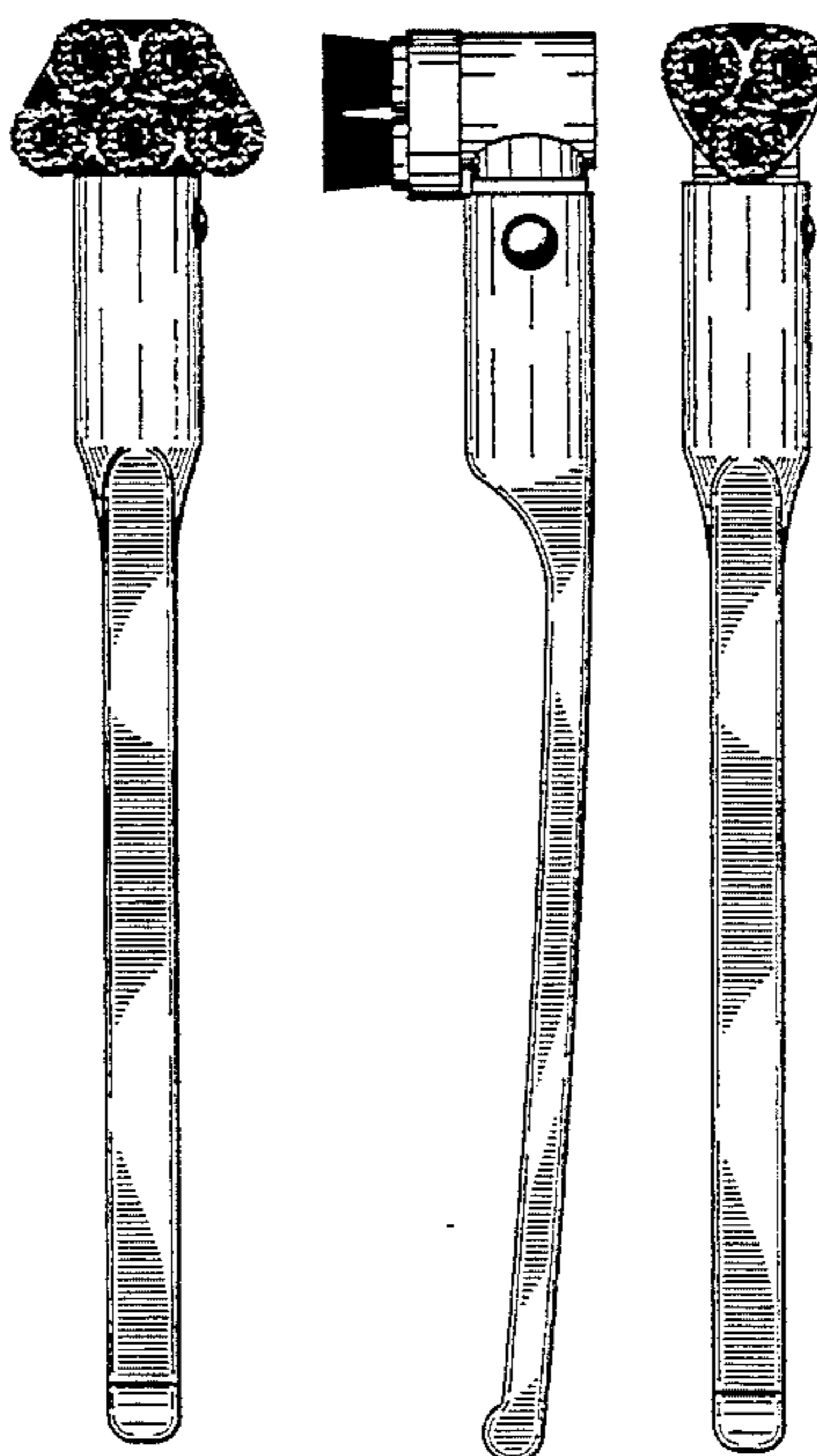

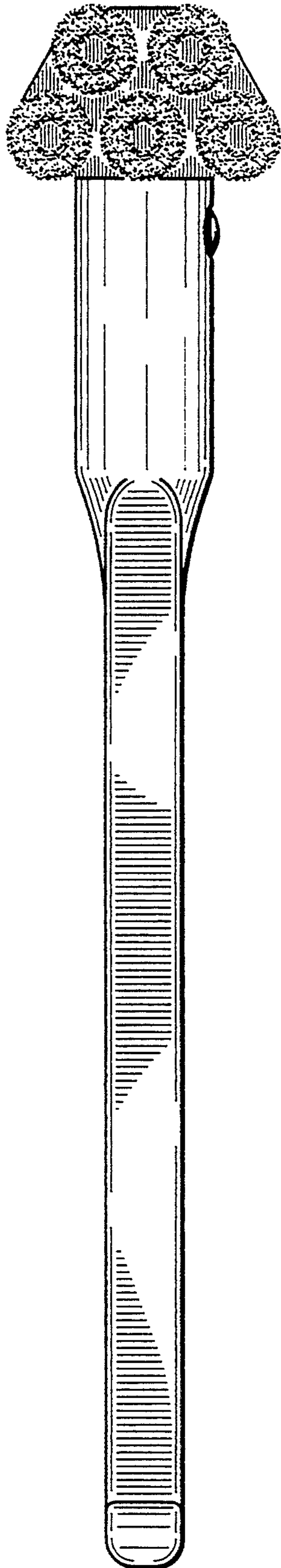

FIG. 1

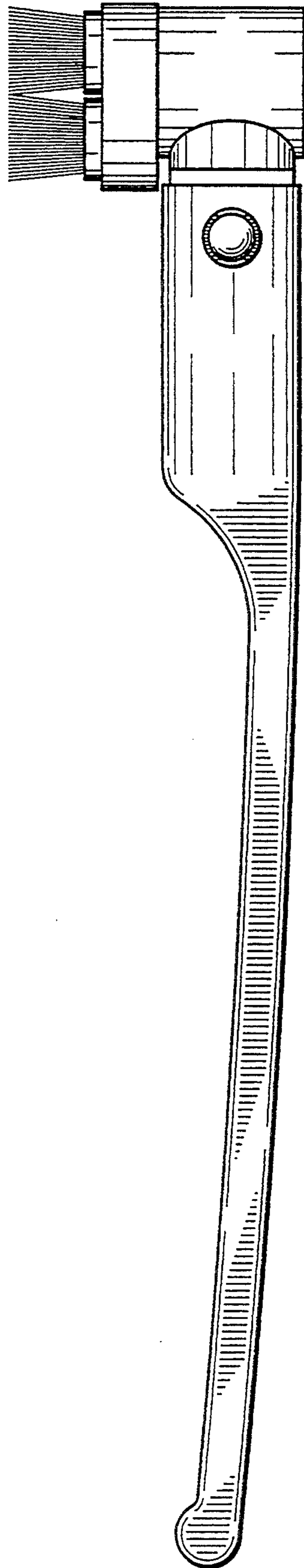

FIG. 2

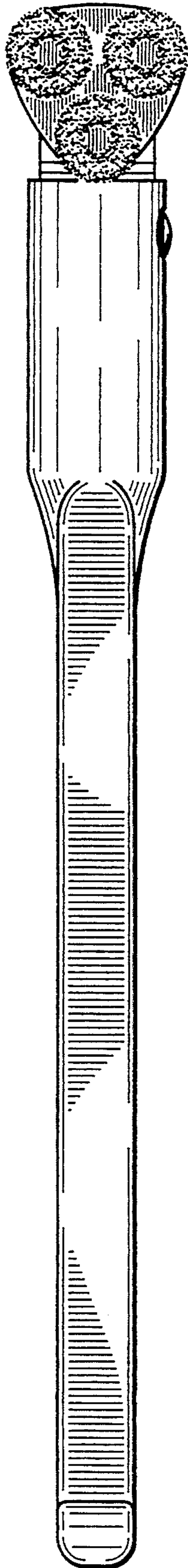

FIG. 3

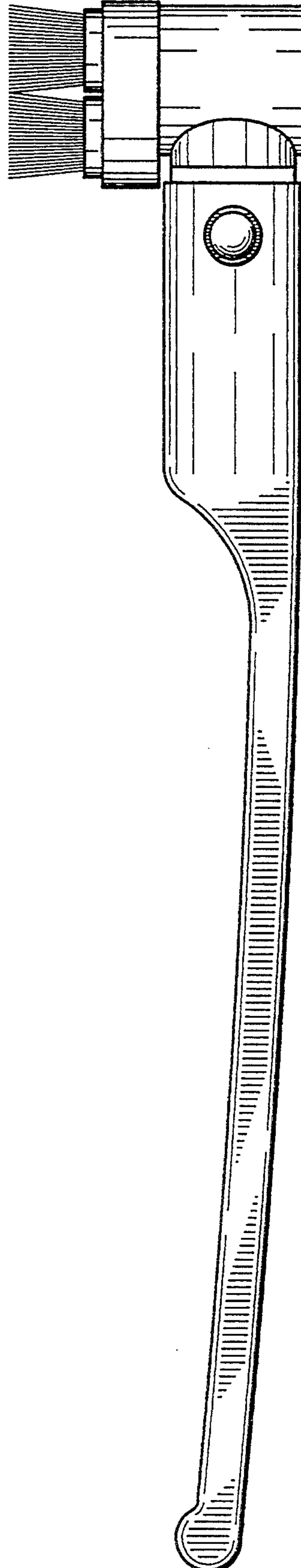

FIG. 4

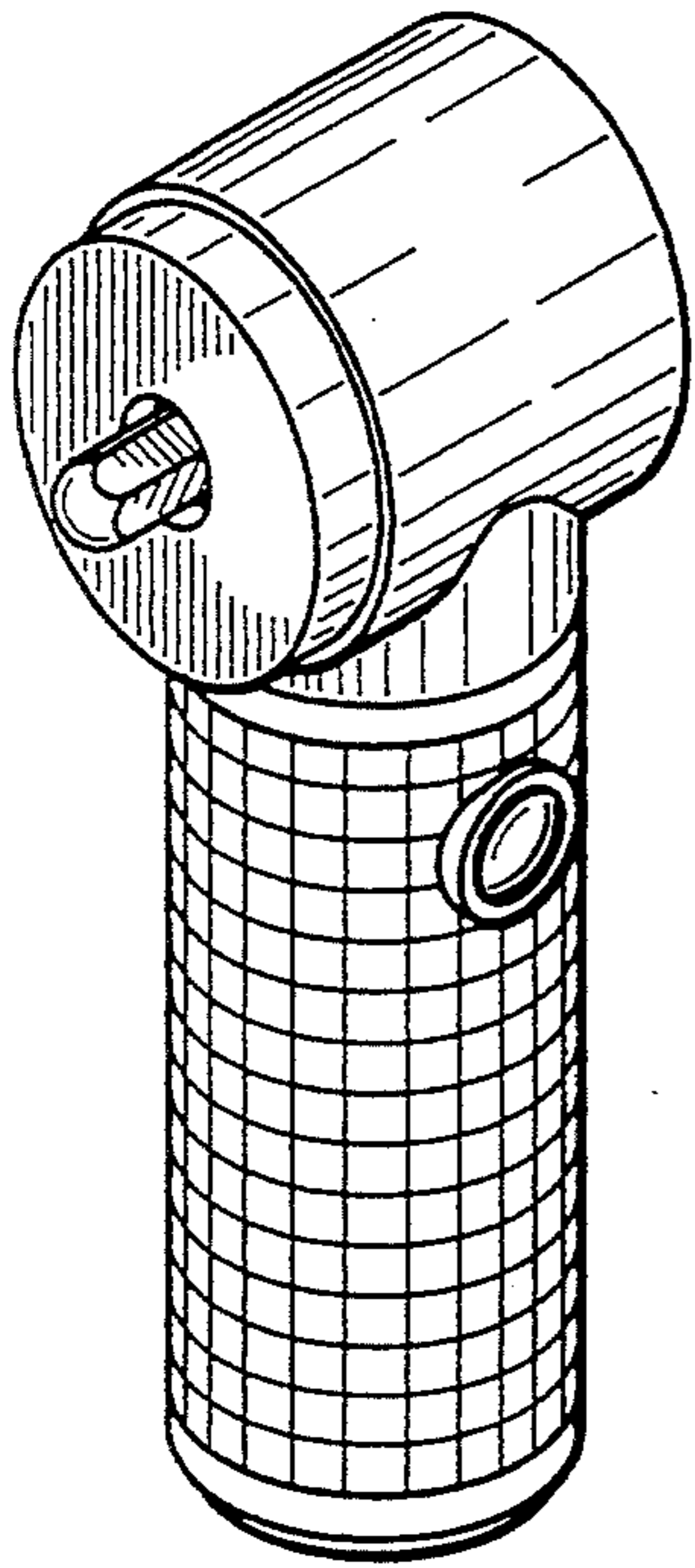

FIG. 5

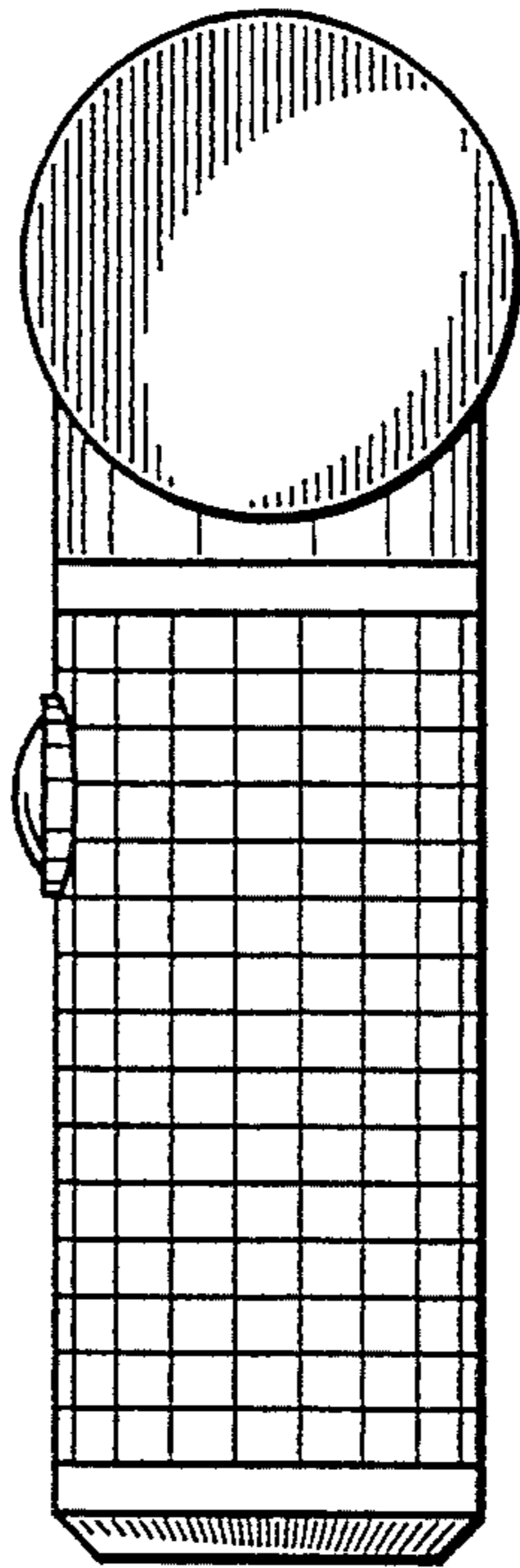

FIG. 6

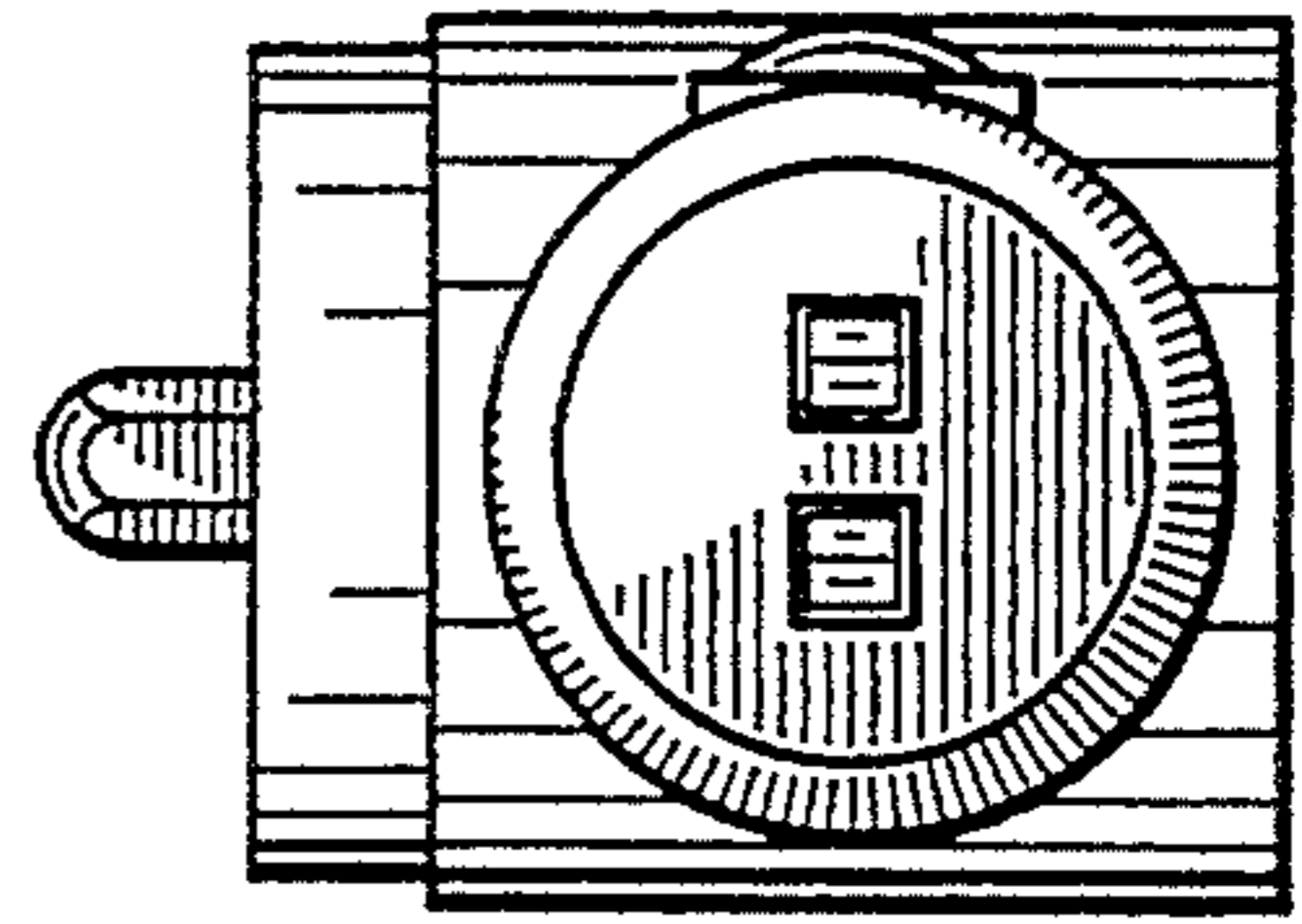

FIG. 7

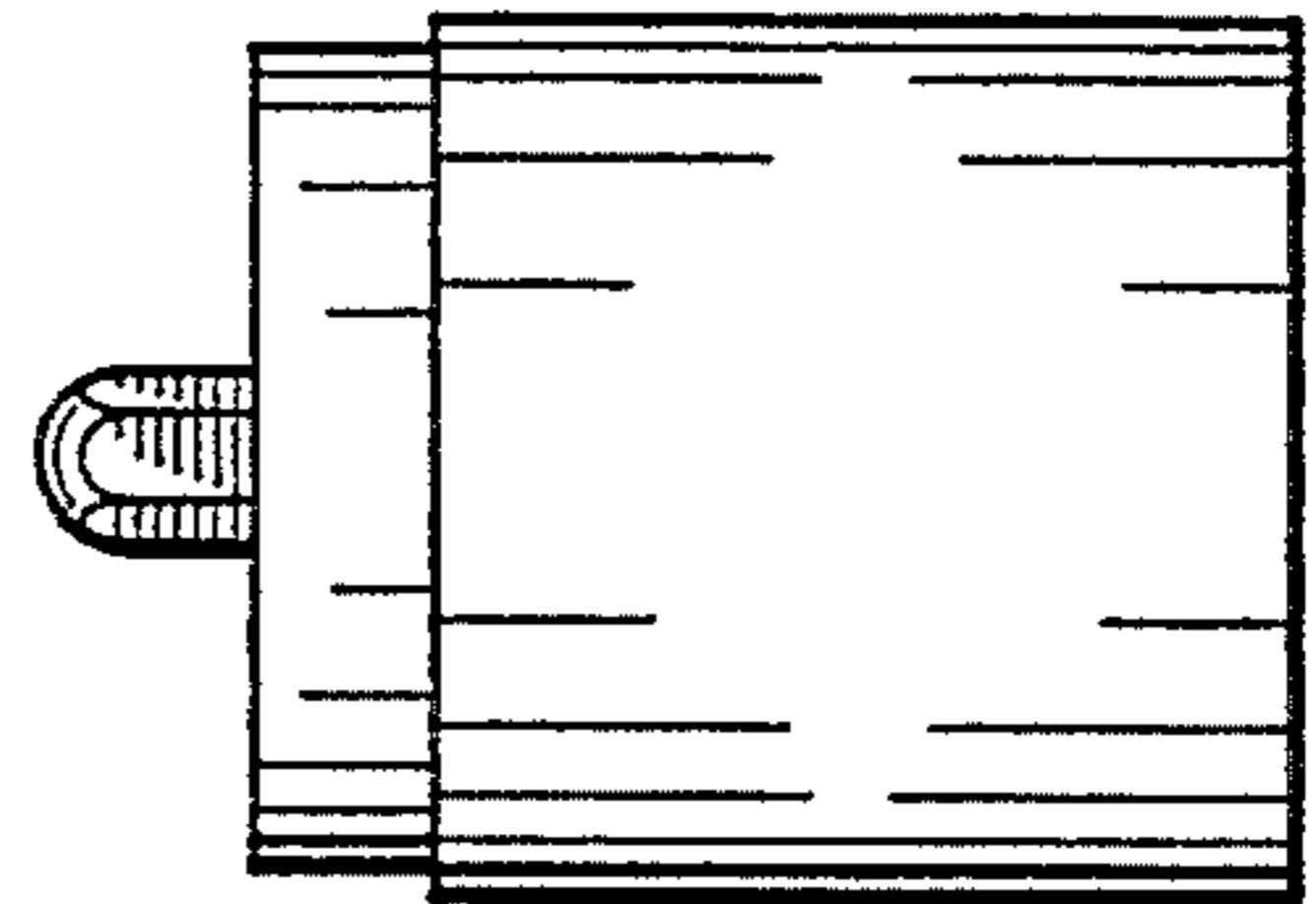

FIG. 8

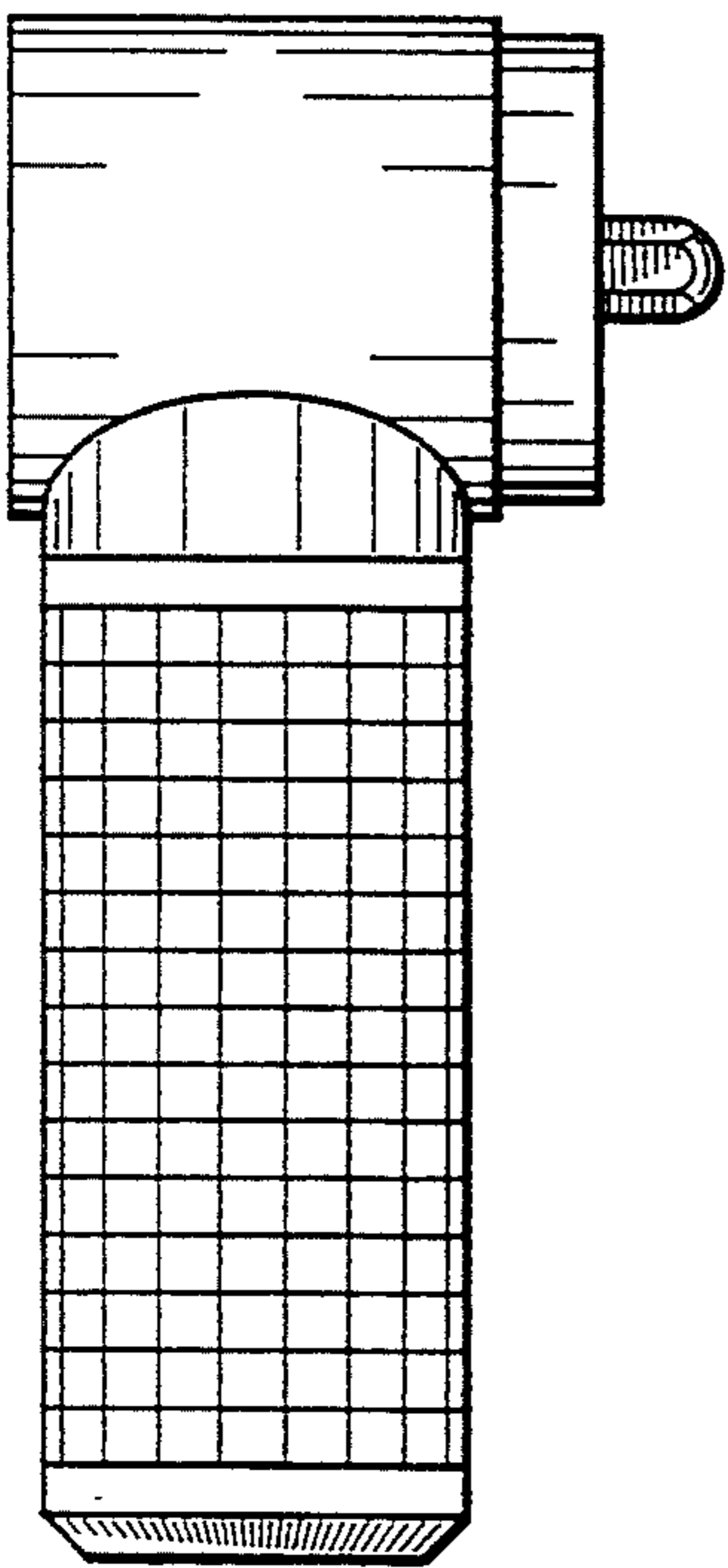

FIG. 9

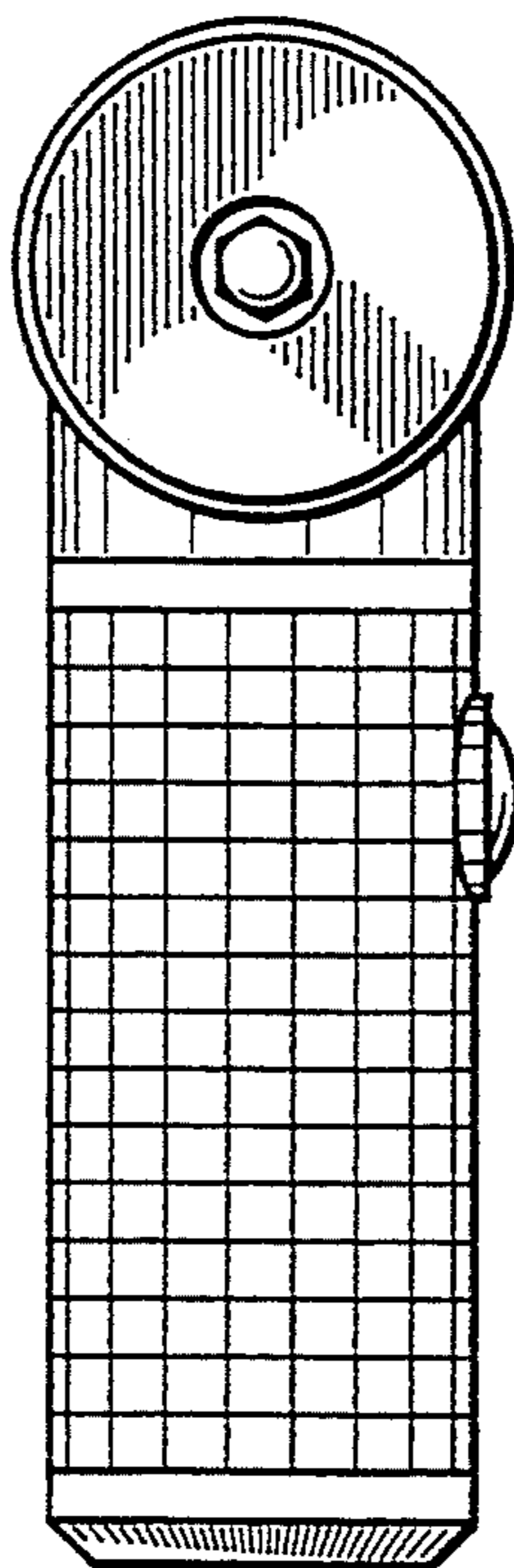

FIG. 10

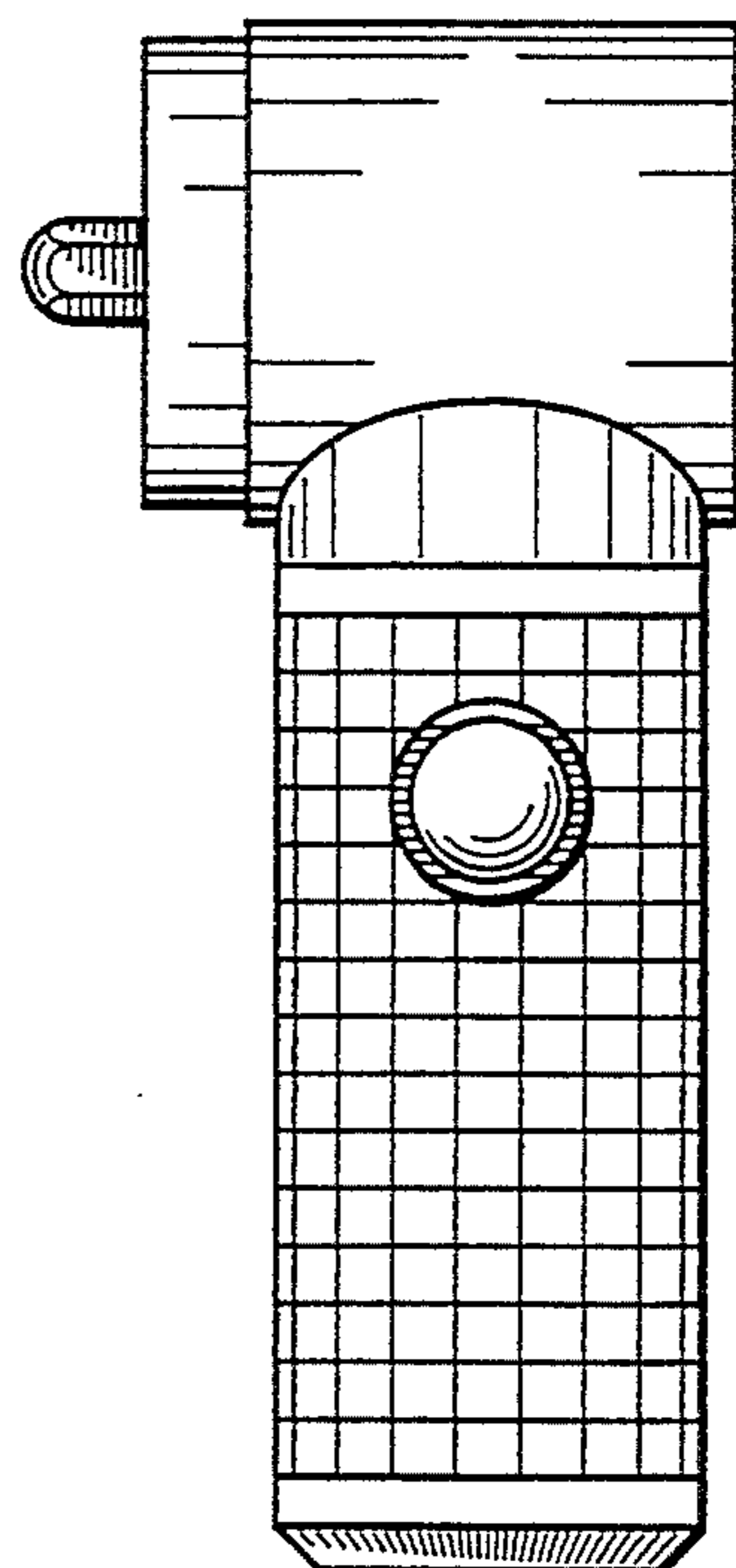

FIG. 11

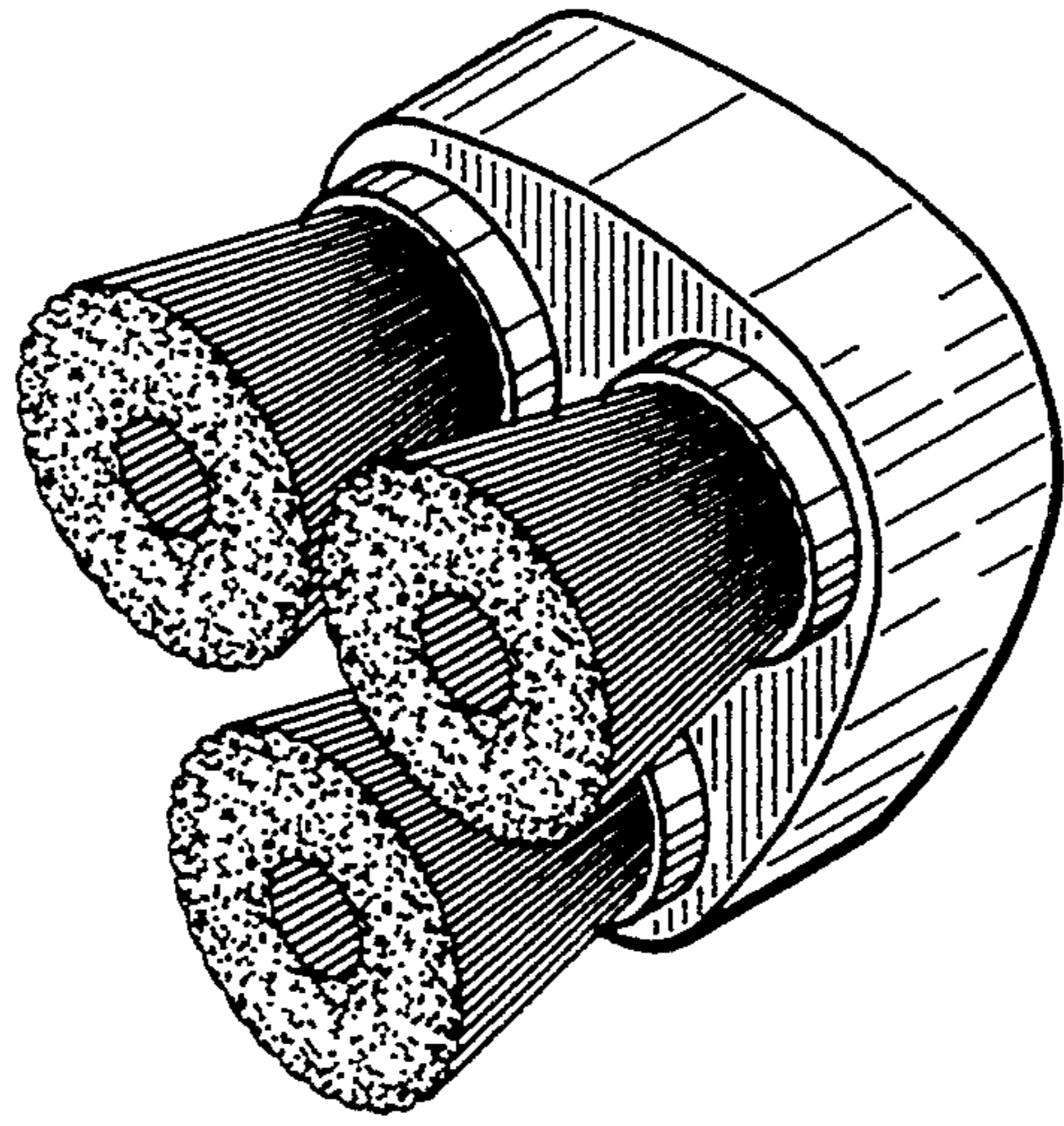

FIG. 12

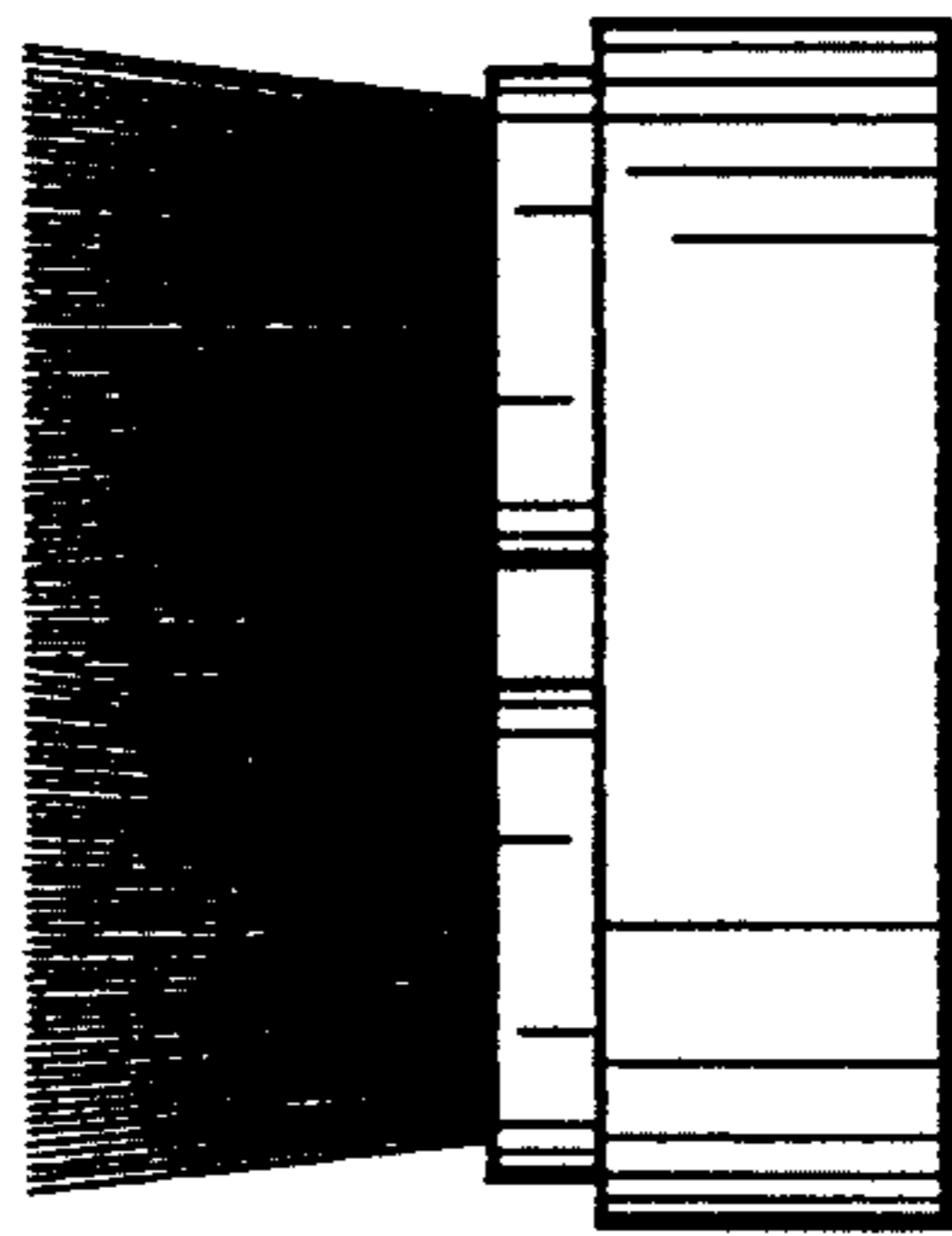

FIG. 13

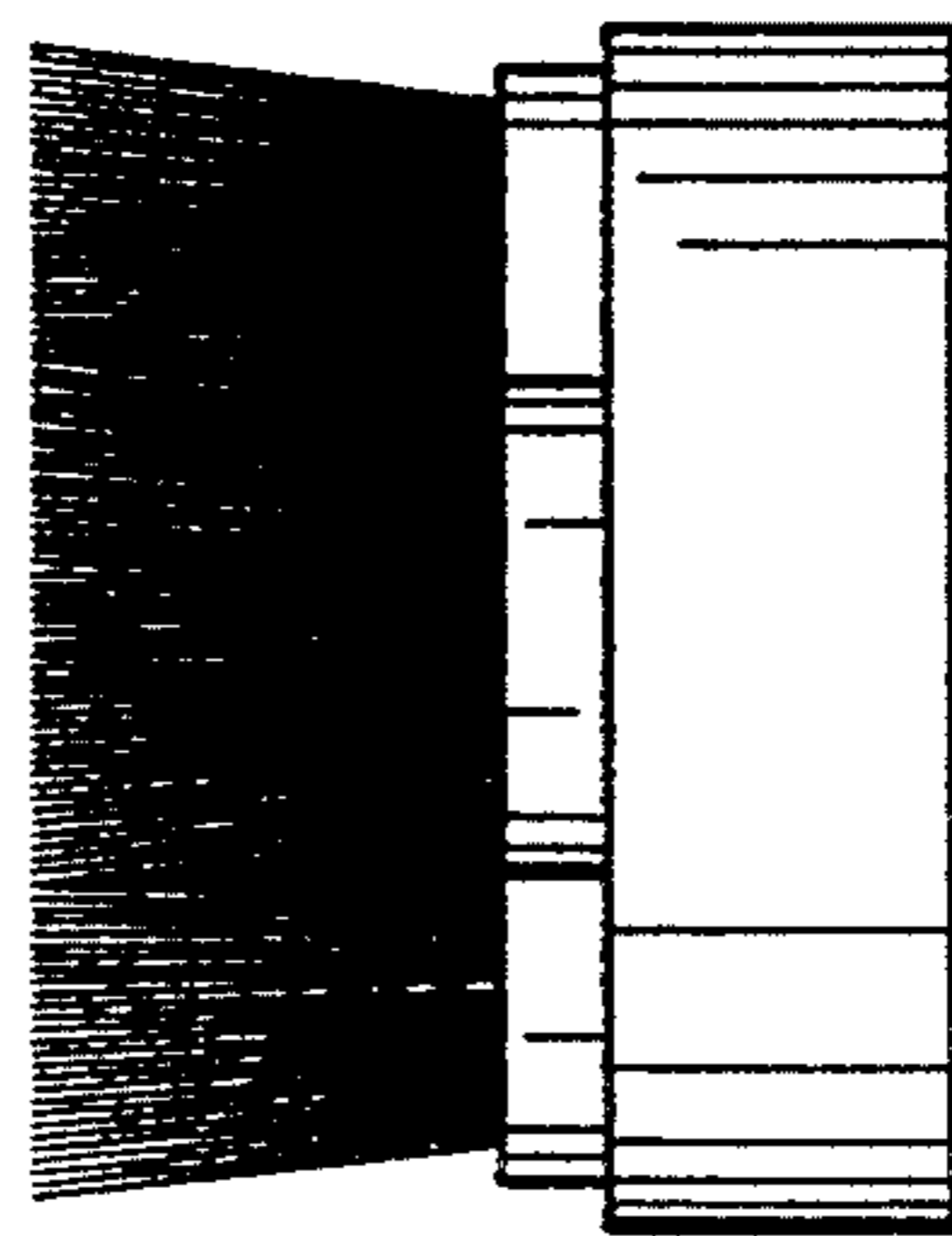

FIG. 14

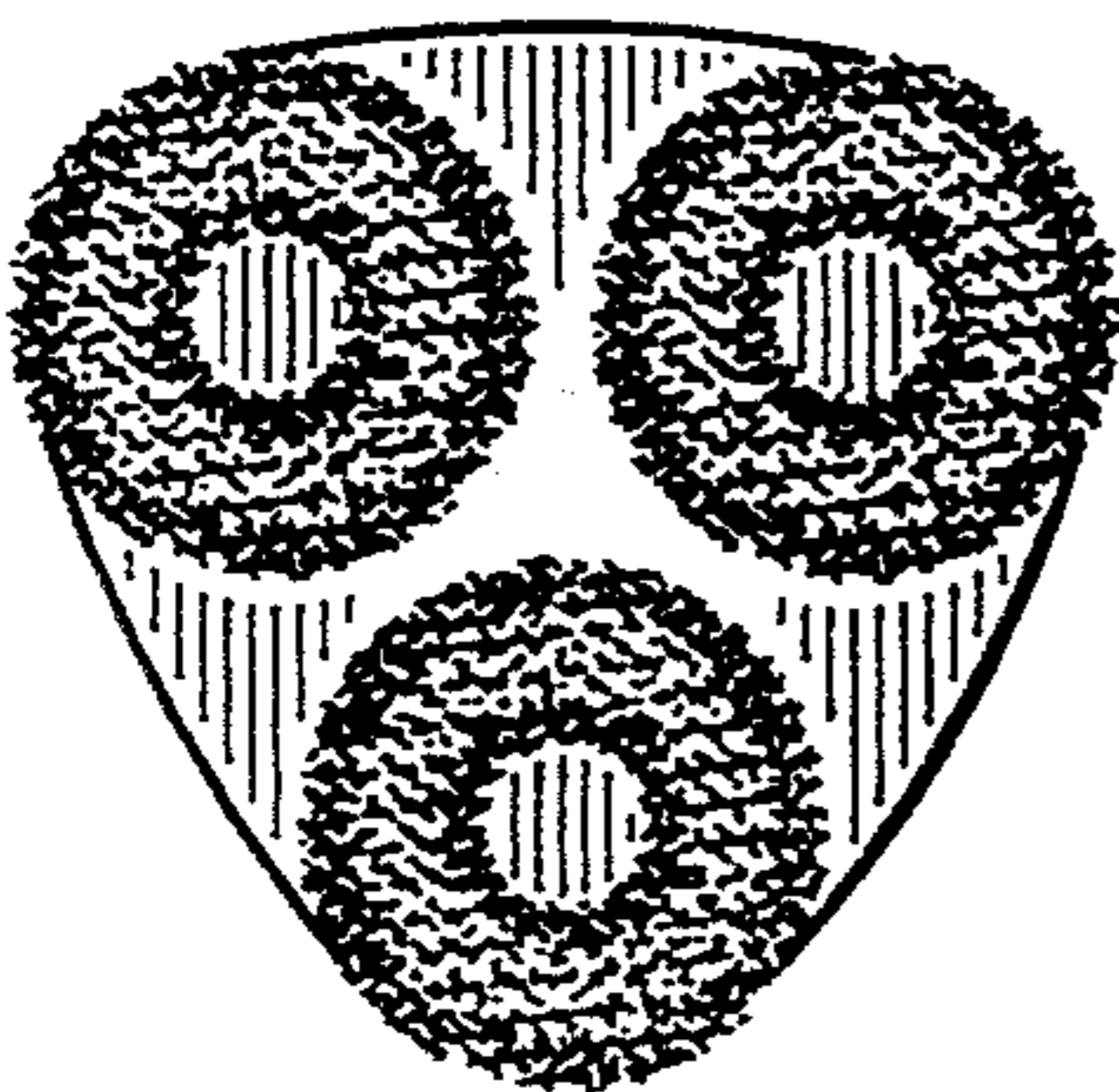

FIG. 15

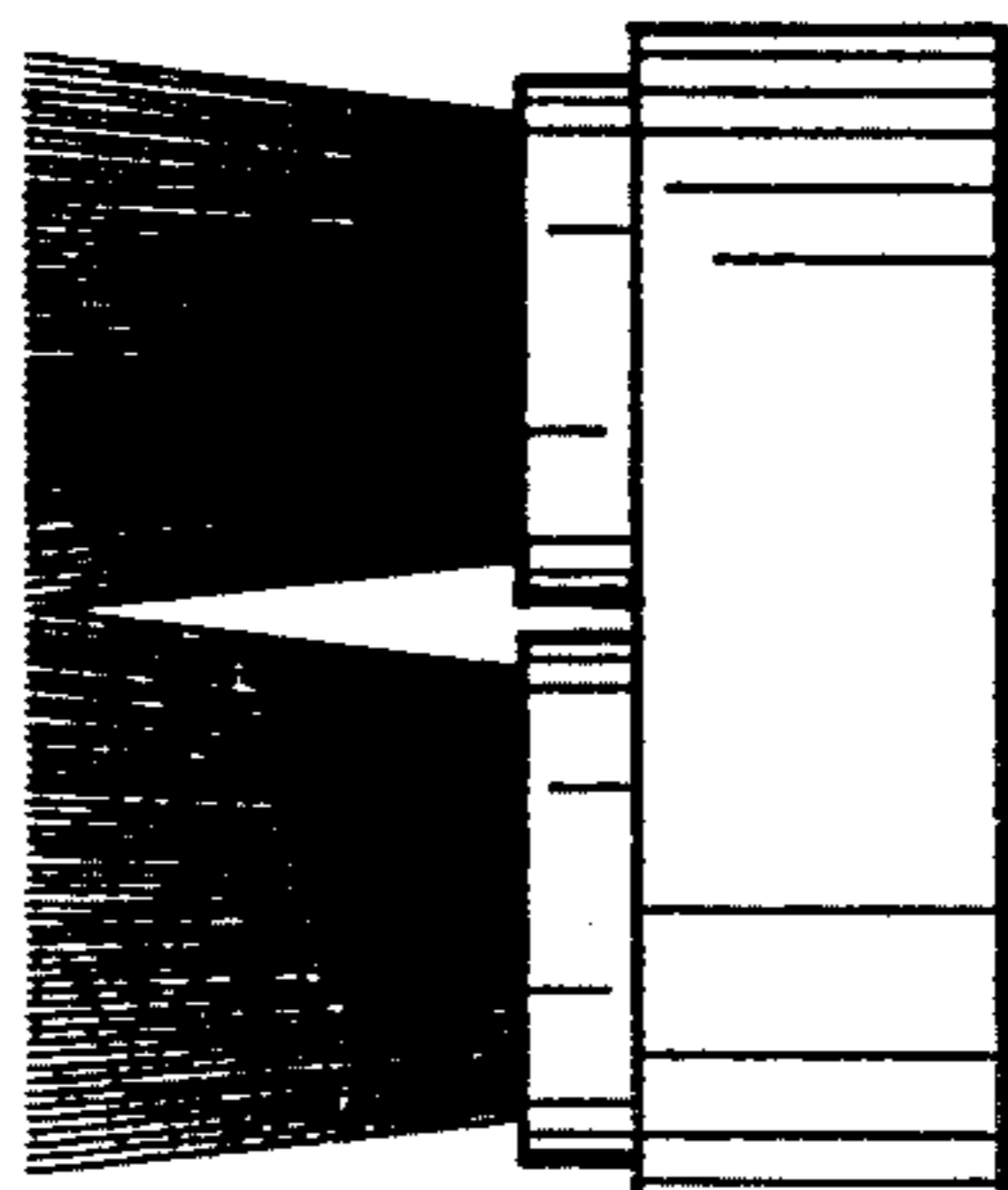

FIG. 16

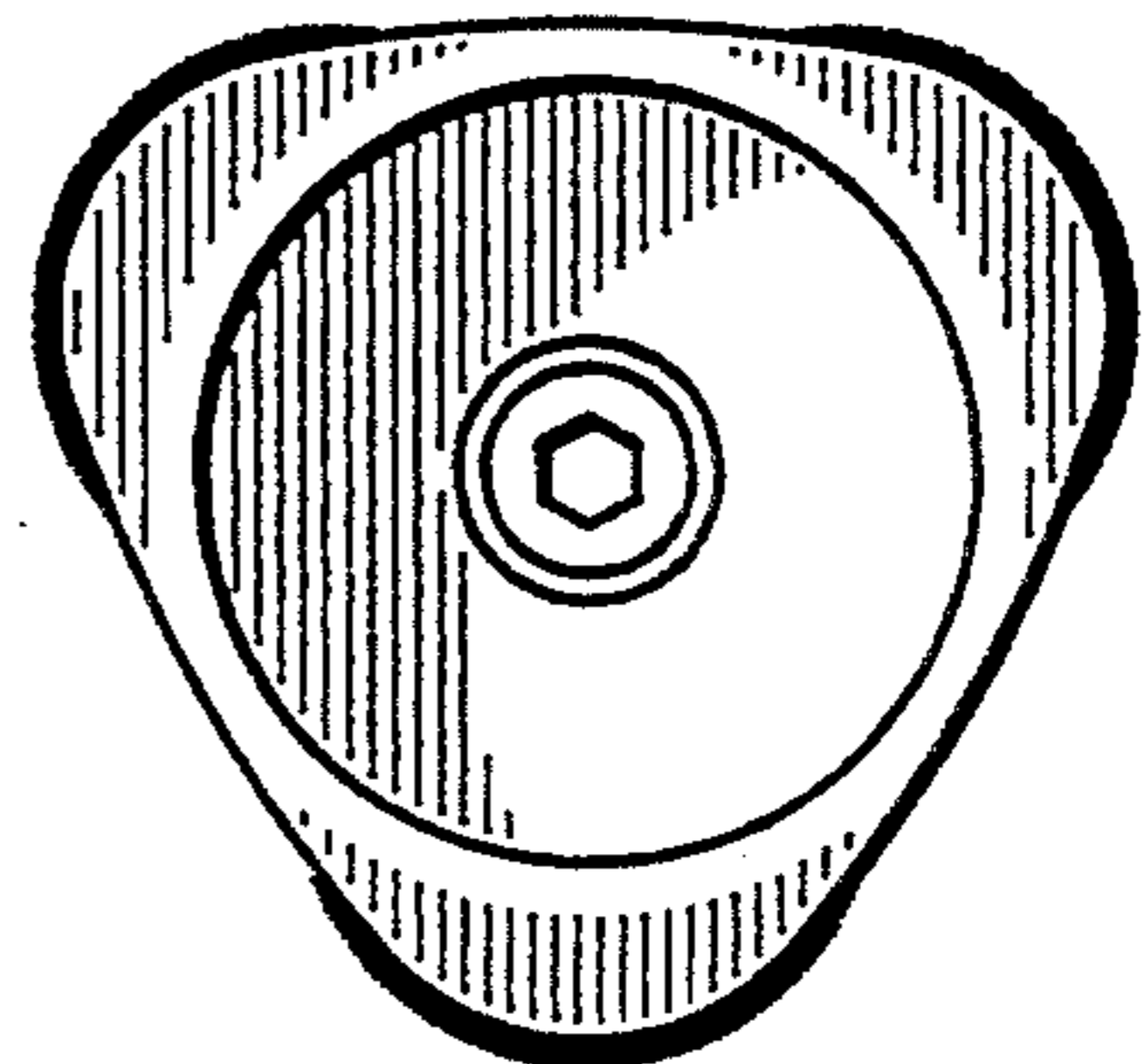

FIG. 17

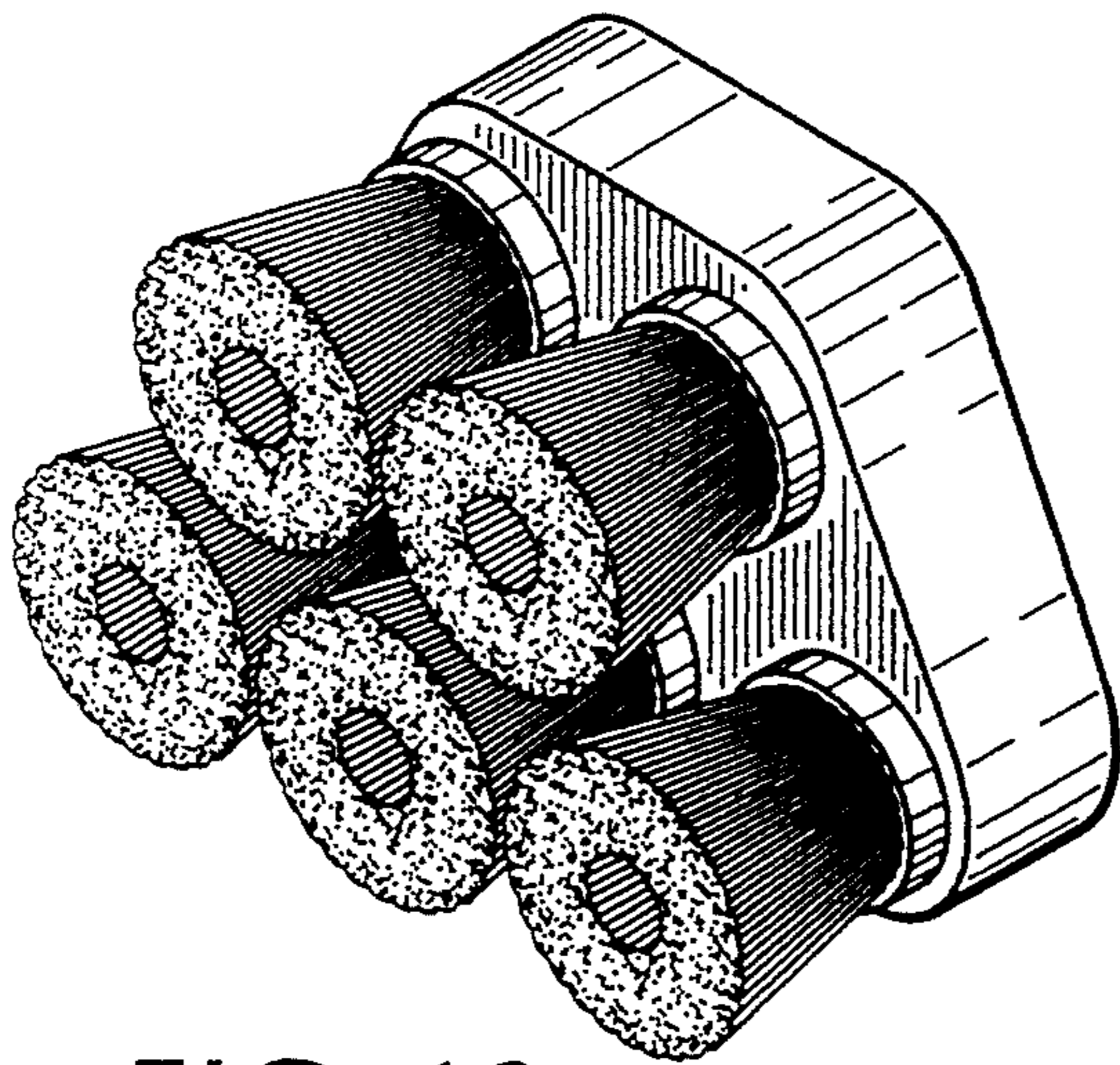

FIG. 18

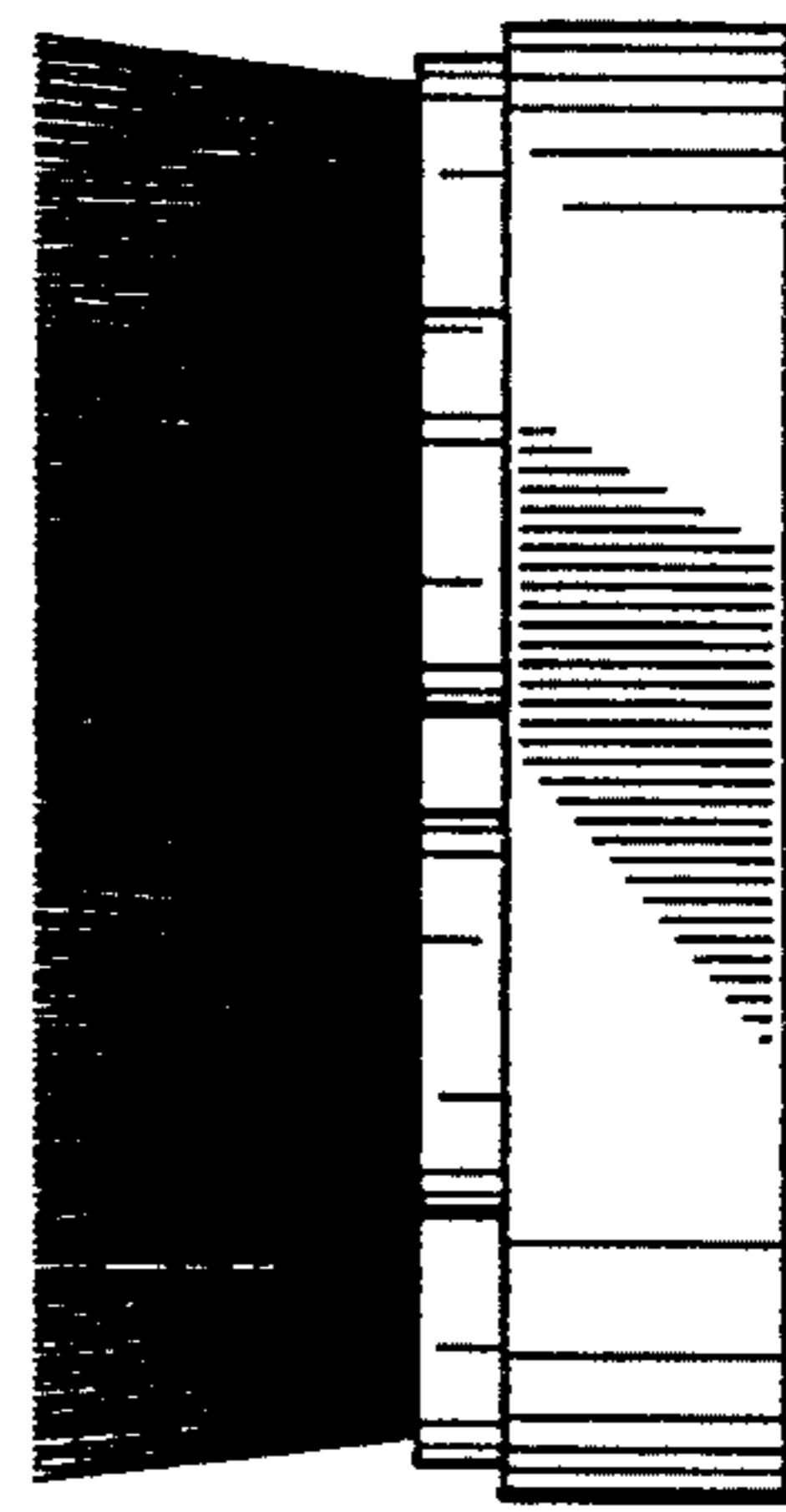

FIG. 19

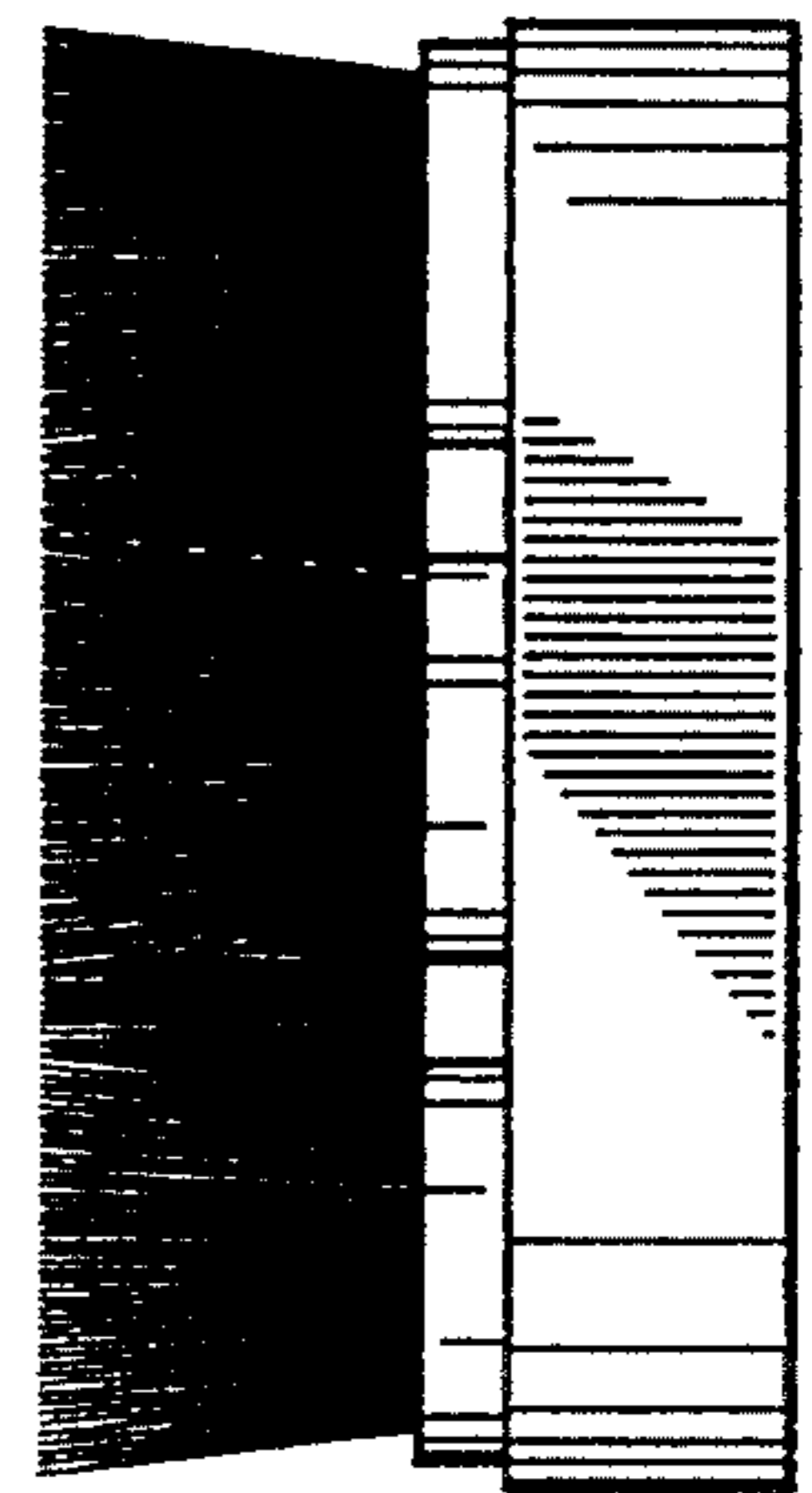

FIG. 20

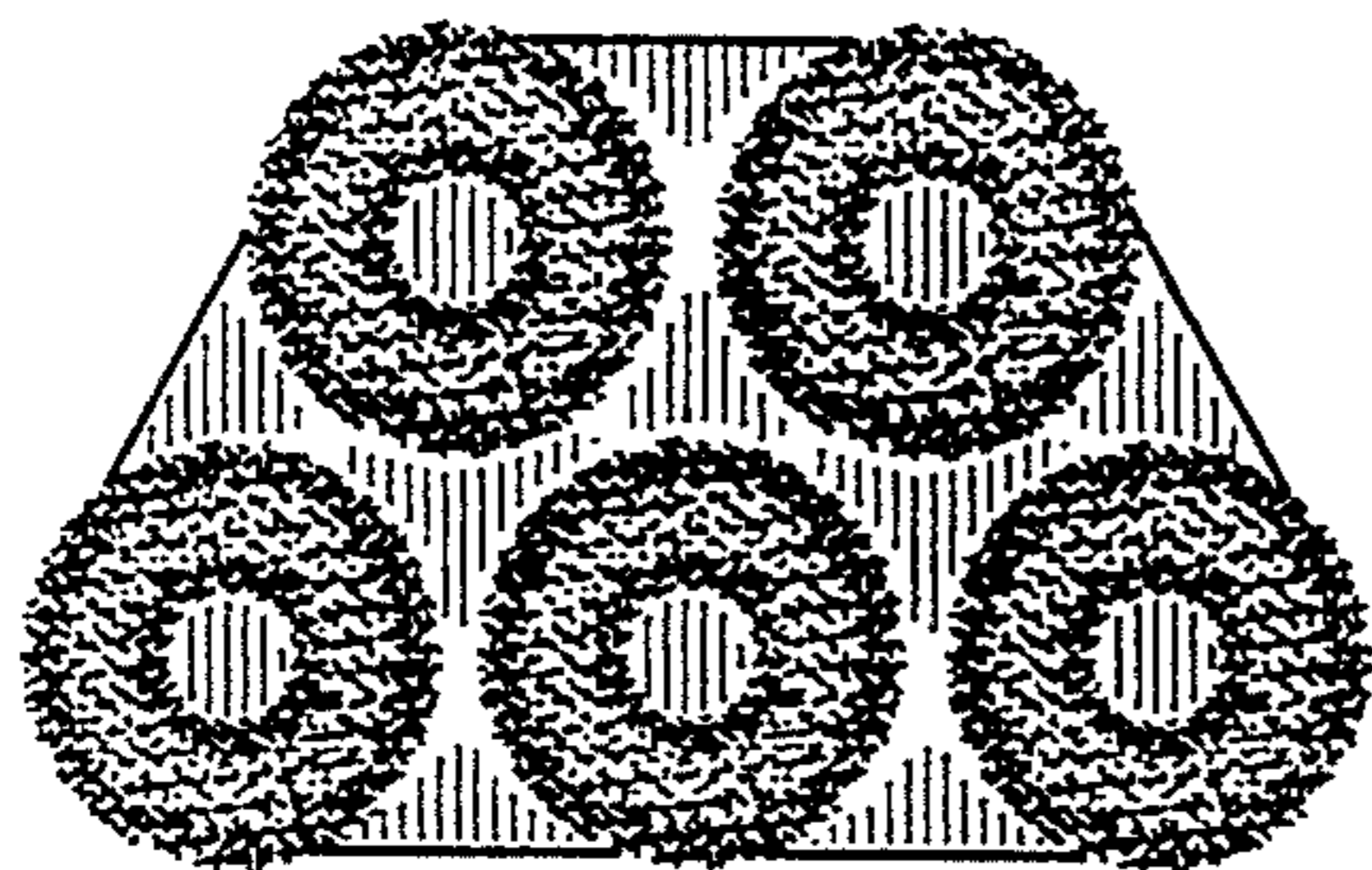

FIG. 21

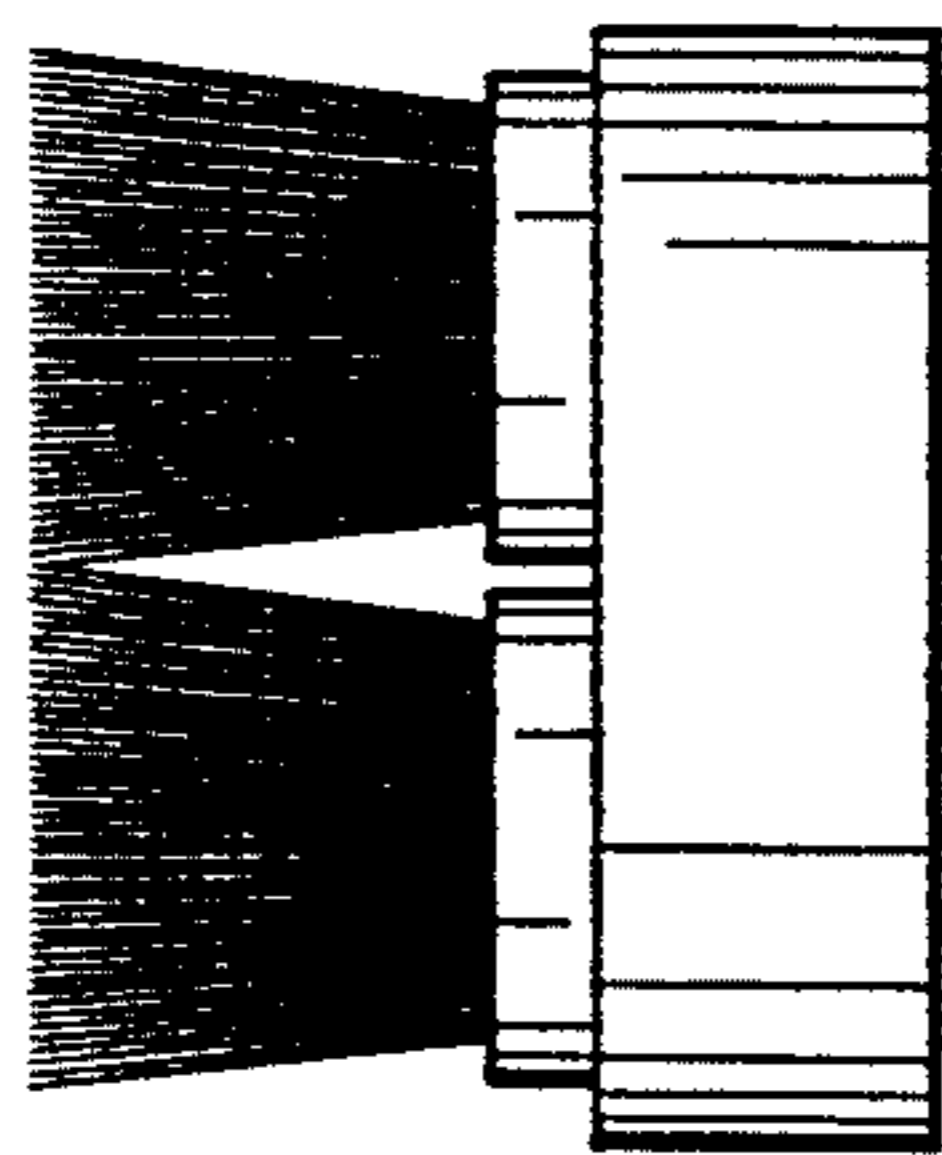

FIG. 22

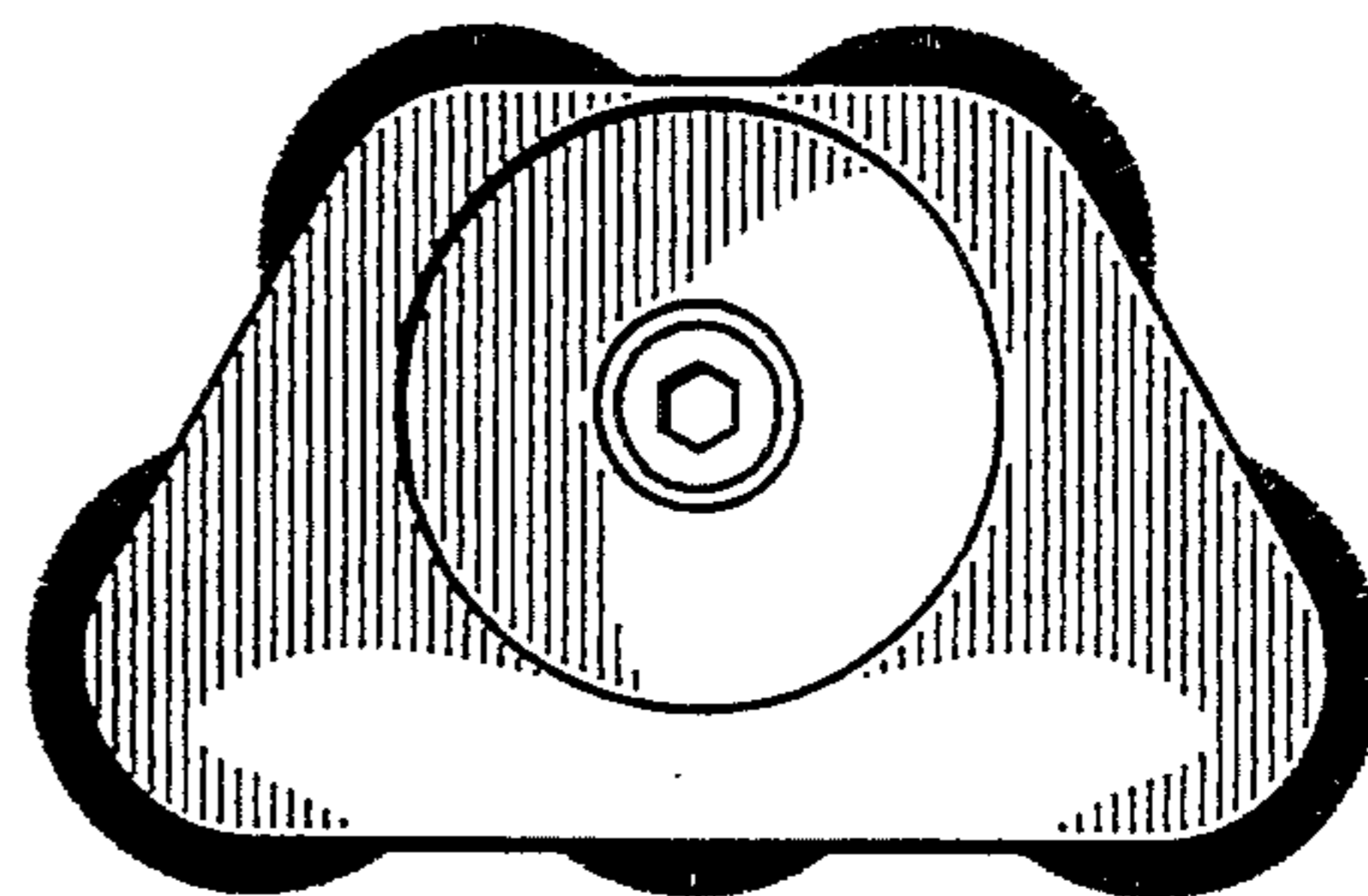

FIG. 23

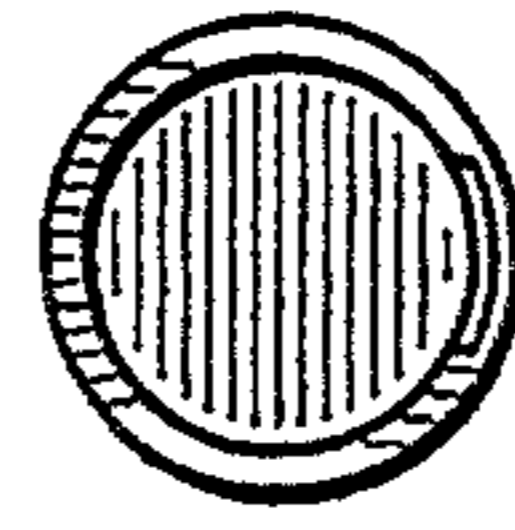

FIG. 24

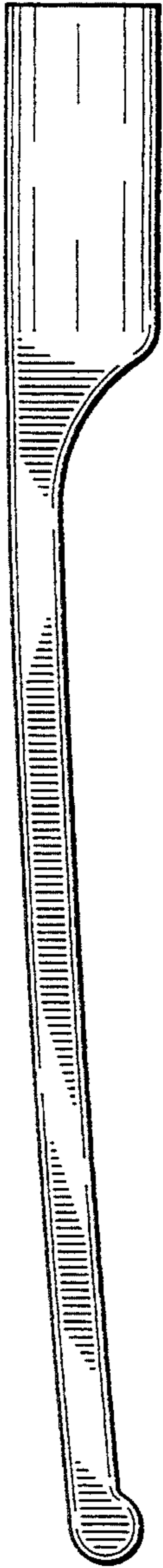

FIG. 25

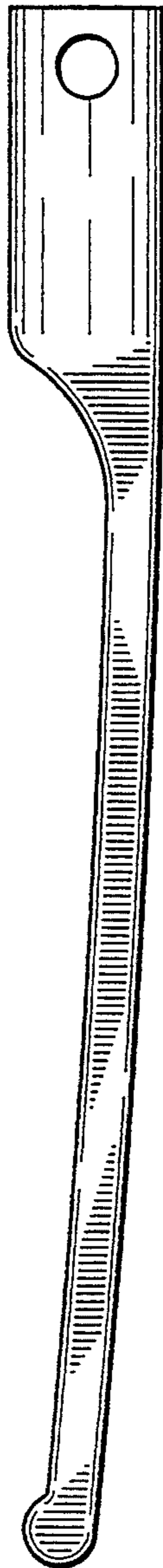

FIG. 26

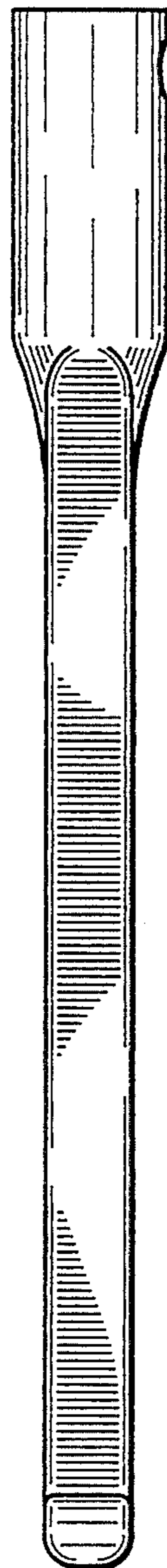

FIG. 27

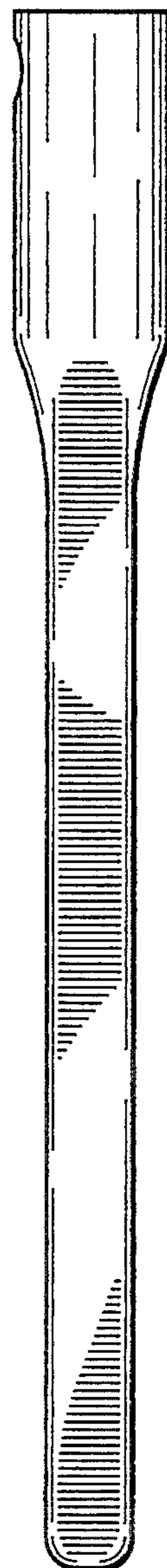

FIG. 28



FIG. 29