



US00D360800S

# United States Patent [19]

[11] Patent Number: **Des. 360,800**

Temple et al.

[45] Date of Patent: **\*\* Aug. 1, 1995**

## [54] MULTI-LEAF HOLDER FOR COMPACT DISKS

[75] Inventors: **James M. Temple; James A. Bergh,** both of Boulder; **Robert P. Stanley,** Longmont, all of Colo.

[73] Assignee: **Case Logic, Inc.,** Longmont, Colo.

[\*\*] Term: **14 Years**

[21] Appl. No.: **20,690**

[22] Filed: **Mar. 31, 1994**

[52] U.S. Cl. .... **D6/629; D6/626**

[58] Field of Search ..... **D3/304; D6/407, 626, D6/629, 630, 632, 633, 634; D19/27, 32, 75, 90; 206/310, 311, 312, 316.1, 387, 425, 444, 528; 211/40, 41**

### [56] References Cited

#### U.S. PATENT DOCUMENTS

D. 262,891	2/1982	Nast	.....	D6/626
D. 268,190	3/1983	Nast	.....	D6/626
D. 271,700	12/1983	Boughner et al.	.....	D6/626
D. 304,781	11/1989	Hanson	.....	D6/629
D. 312,532	12/1990	Prey	.....	D19/27
D. 314,977	2/1991	Wyant	.....	D19/27
D. 316,180	4/1991	Hines	.....	D6/629
D. 323,428	1/1992	Wang	.....	D6/630
D. 346,180	4/1994	Sandoval	.....	D19/27
D. 350,448	9/1994	Hill	.....	D6/630
4,519,500	5/1985	Perchak	.....	206/312
5,193,681	3/1993	Lievsay	.....	206/444

*Primary Examiner*—C. A. Murphy  
*Attorney, Agent, or Firm*—Francis A. Sirr; Earl C. Hancock

### [57] CLAIM

The ornamental design for a multi-leaf holder for compact disks, as shown and described.

### DESCRIPTION

FIG. 1 is a perspective view of a multi-leaf holder for compact disks showing our new design; FIG. 2 is a top plan view thereof, the bottom being a mirror image; FIG. 3 is an inside elevational view thereof shown in an open position; the leaves not shown having a front surface identical to the right hand page, and a rear surface identical to the left hand page; FIG. 4 is a perspective view of an alternate embodiment of the design shown in FIG. 1, the sides not shown being mirror images of the sides which are shown; FIG. 5 is a top plan view of FIG. 4, the bottom being a mirror image; FIG. 6 is a top plan view of a second embodiment of the design shown in FIG. 1, the bottom being a mirror image; and the sides being substantially similar to the sides of the previous embodiment; and, FIG. 7 is an inside elevational view of FIG. 4 shown in an open position, the inside elevational view of FIG. 6 being identical except for the rounded outer cover corners on the hinged side; and the leaves not shown having a front surface identical to the reight hand page, and a rear surface identical to the left hand page.

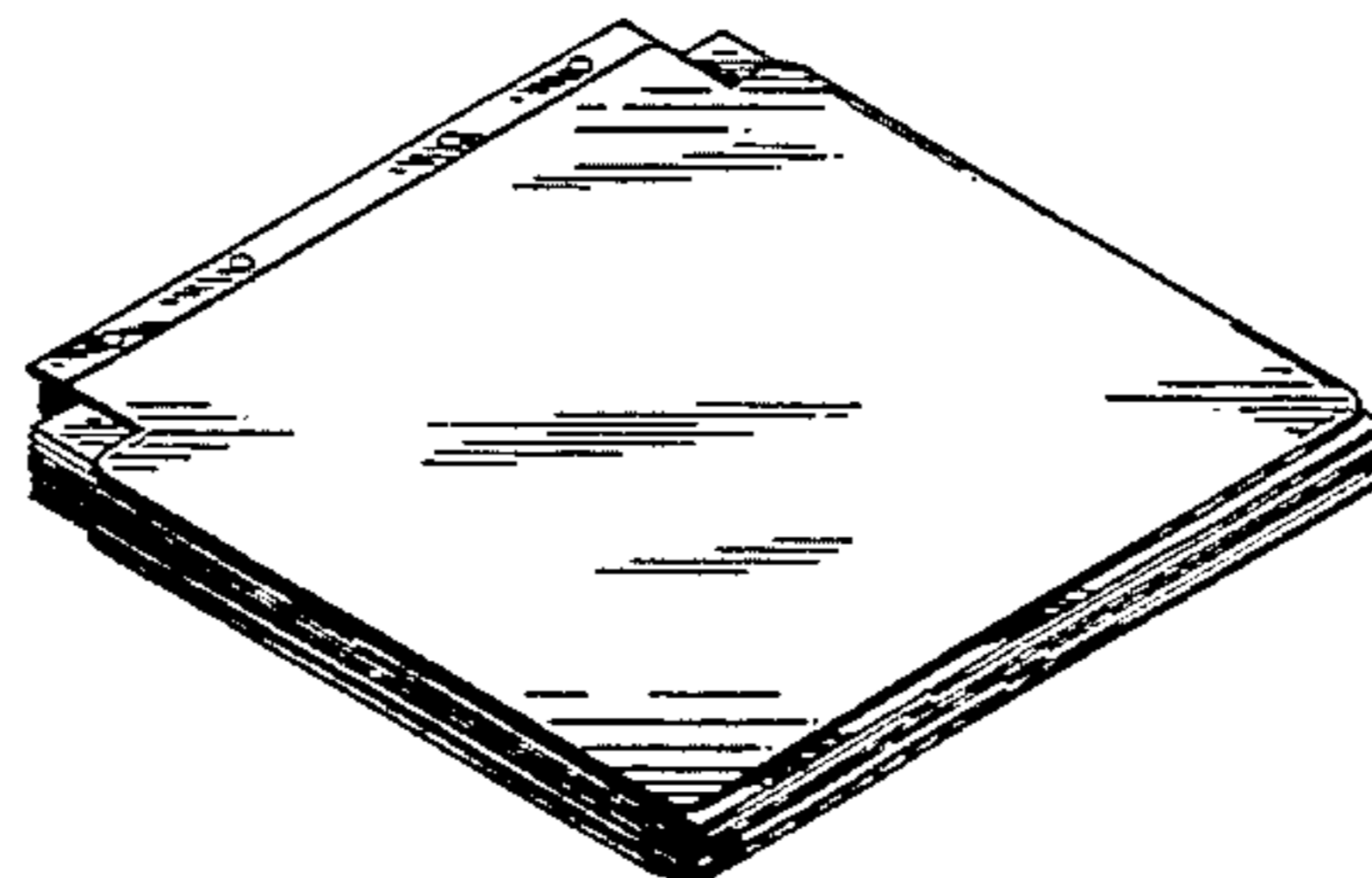
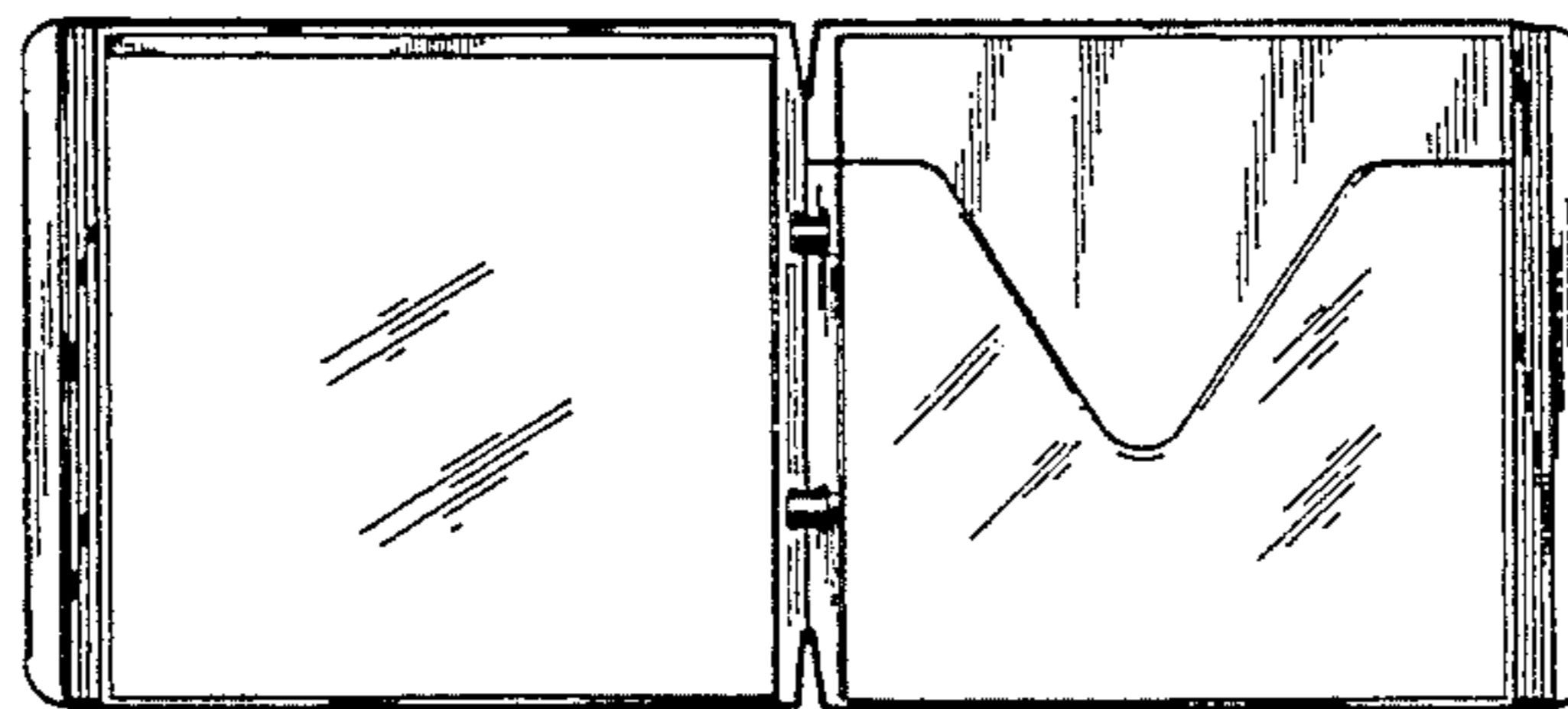
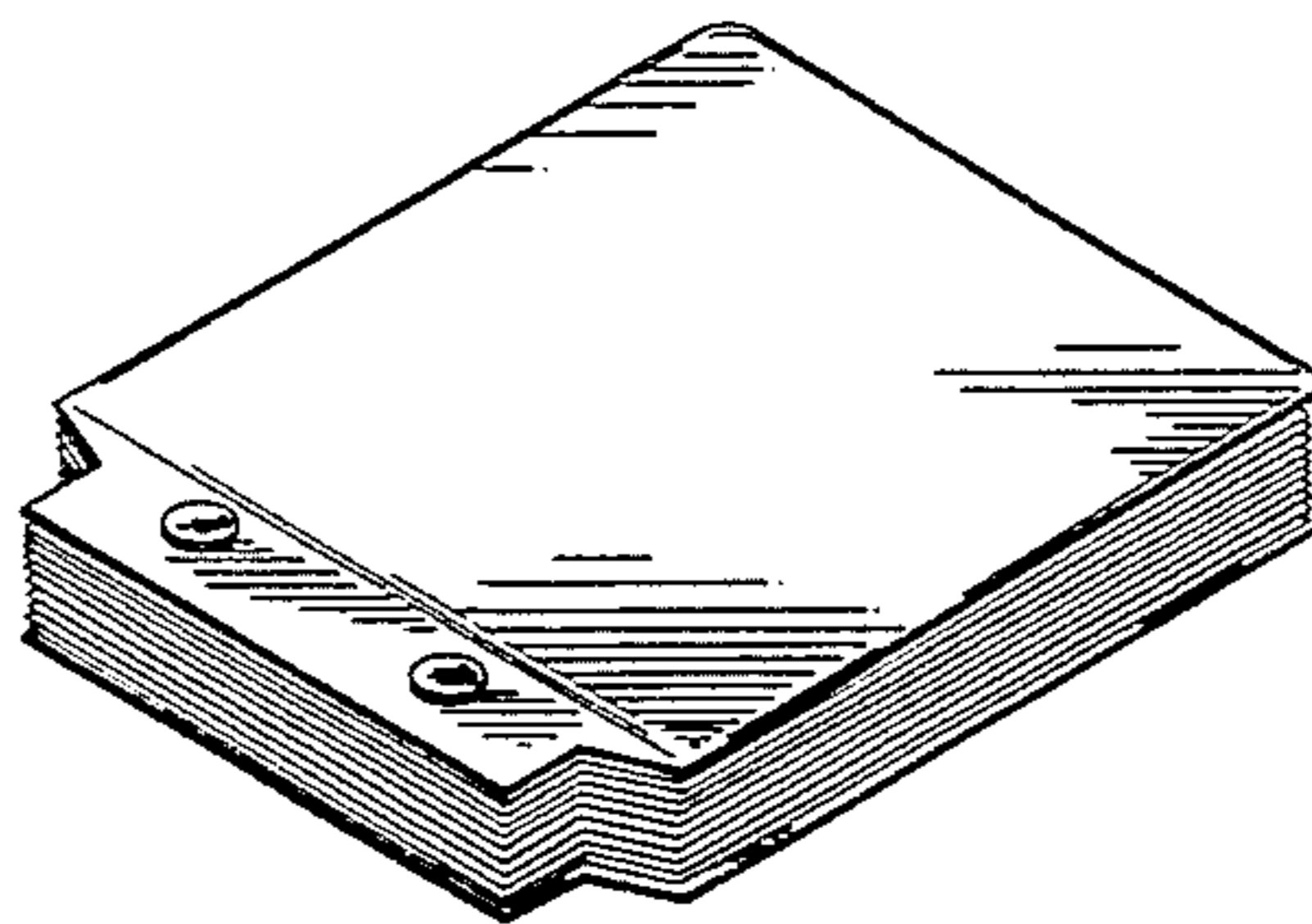

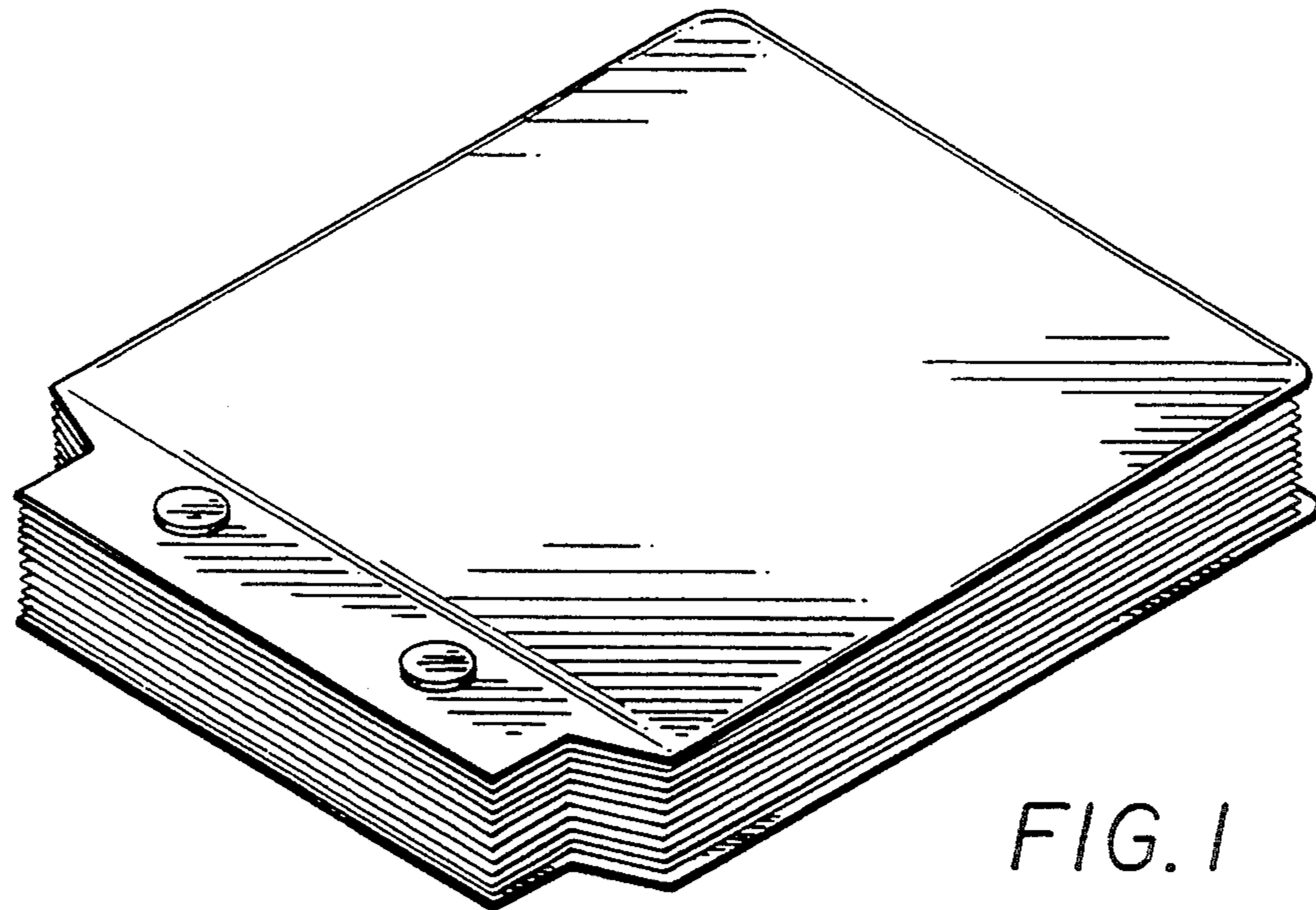

FIG. 1

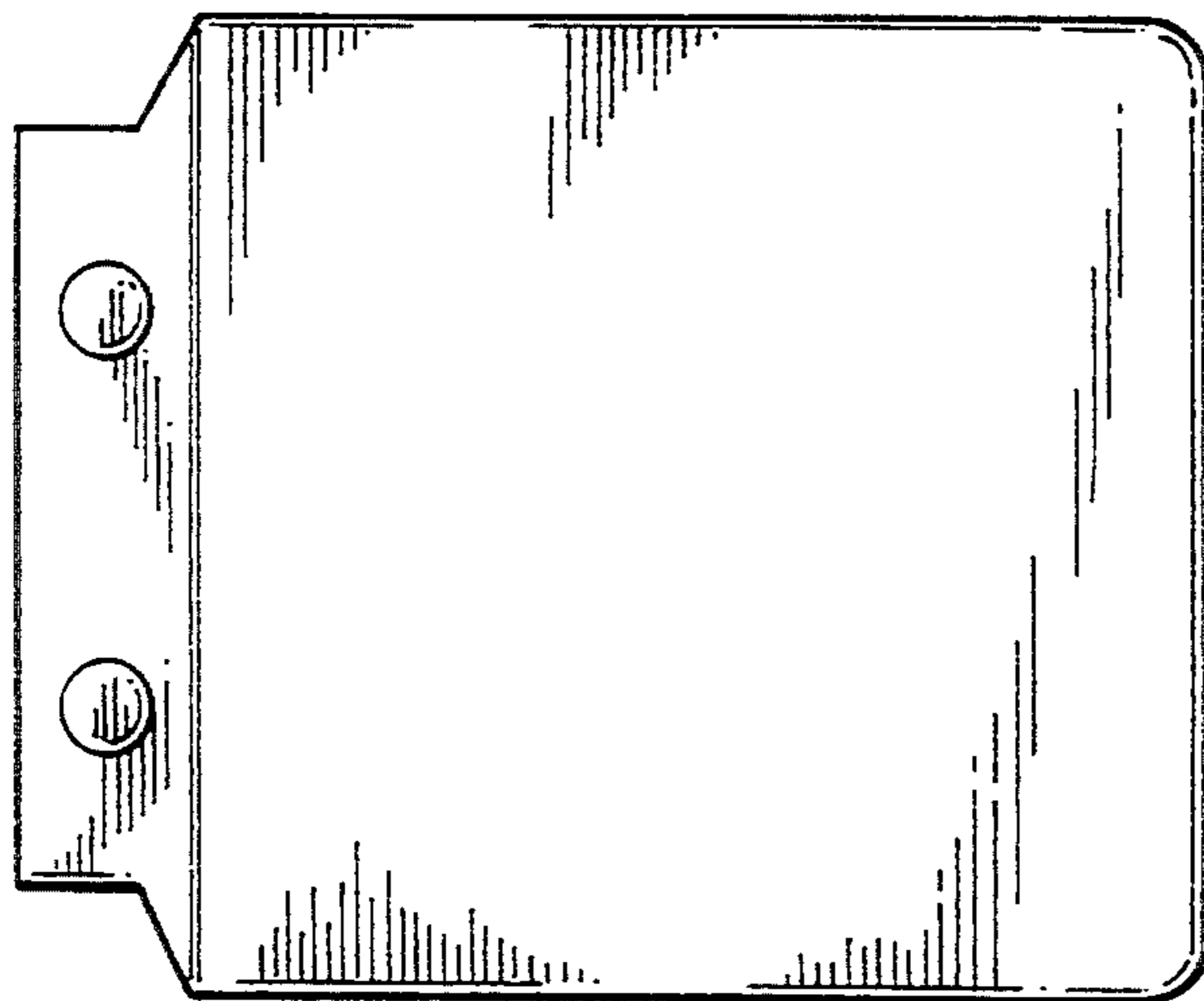

FIG. 2

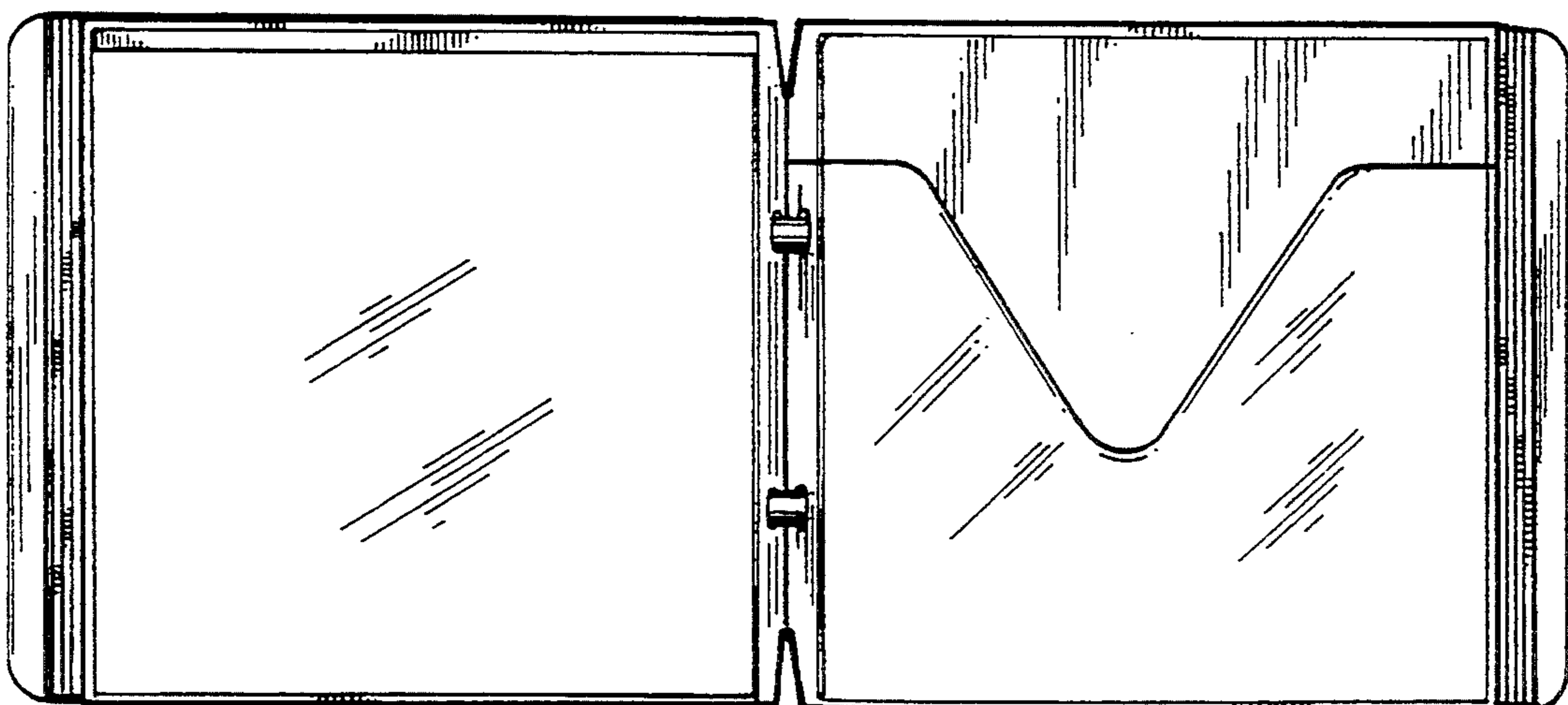

FIG. 3

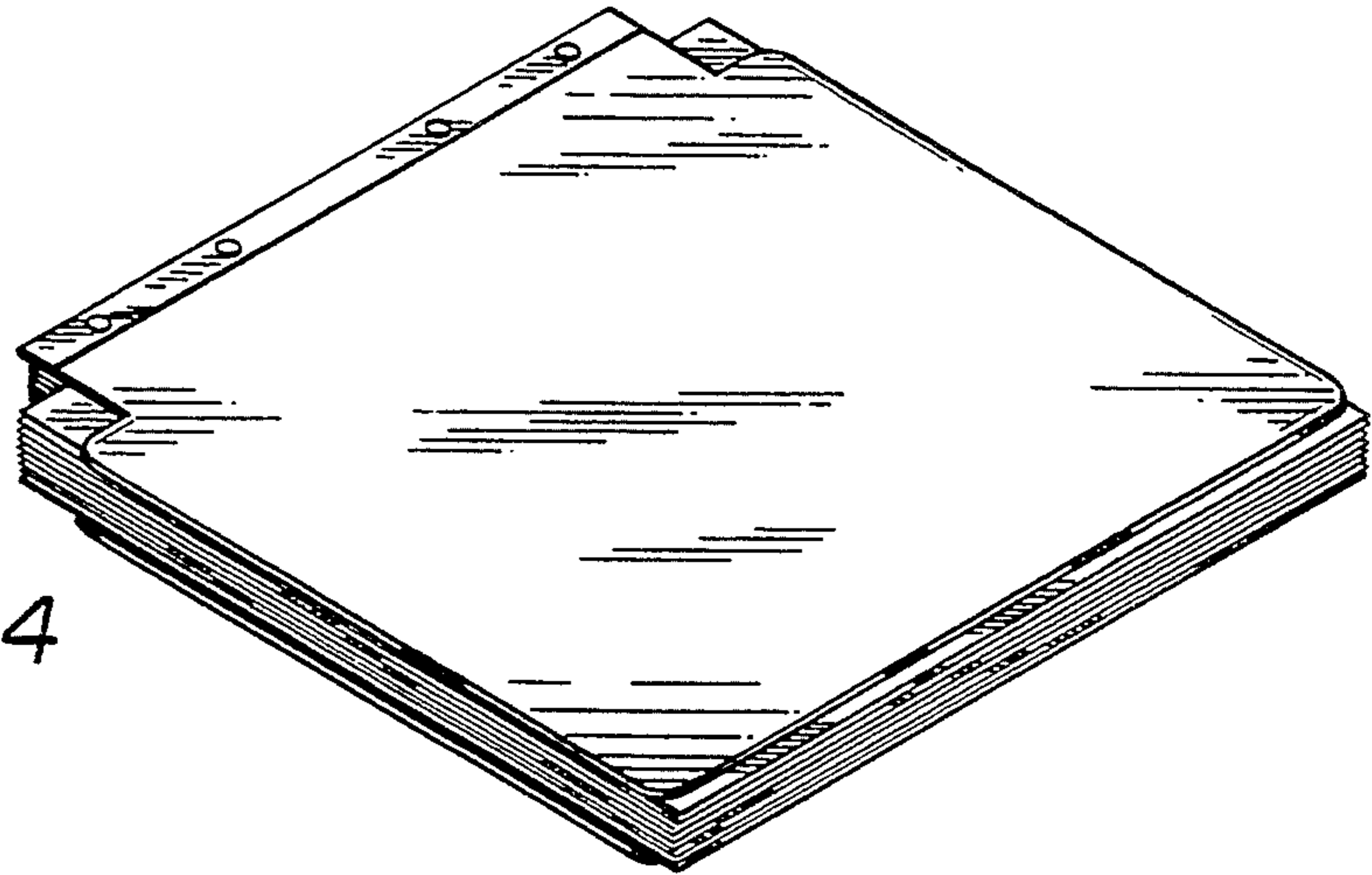

FIG. 4

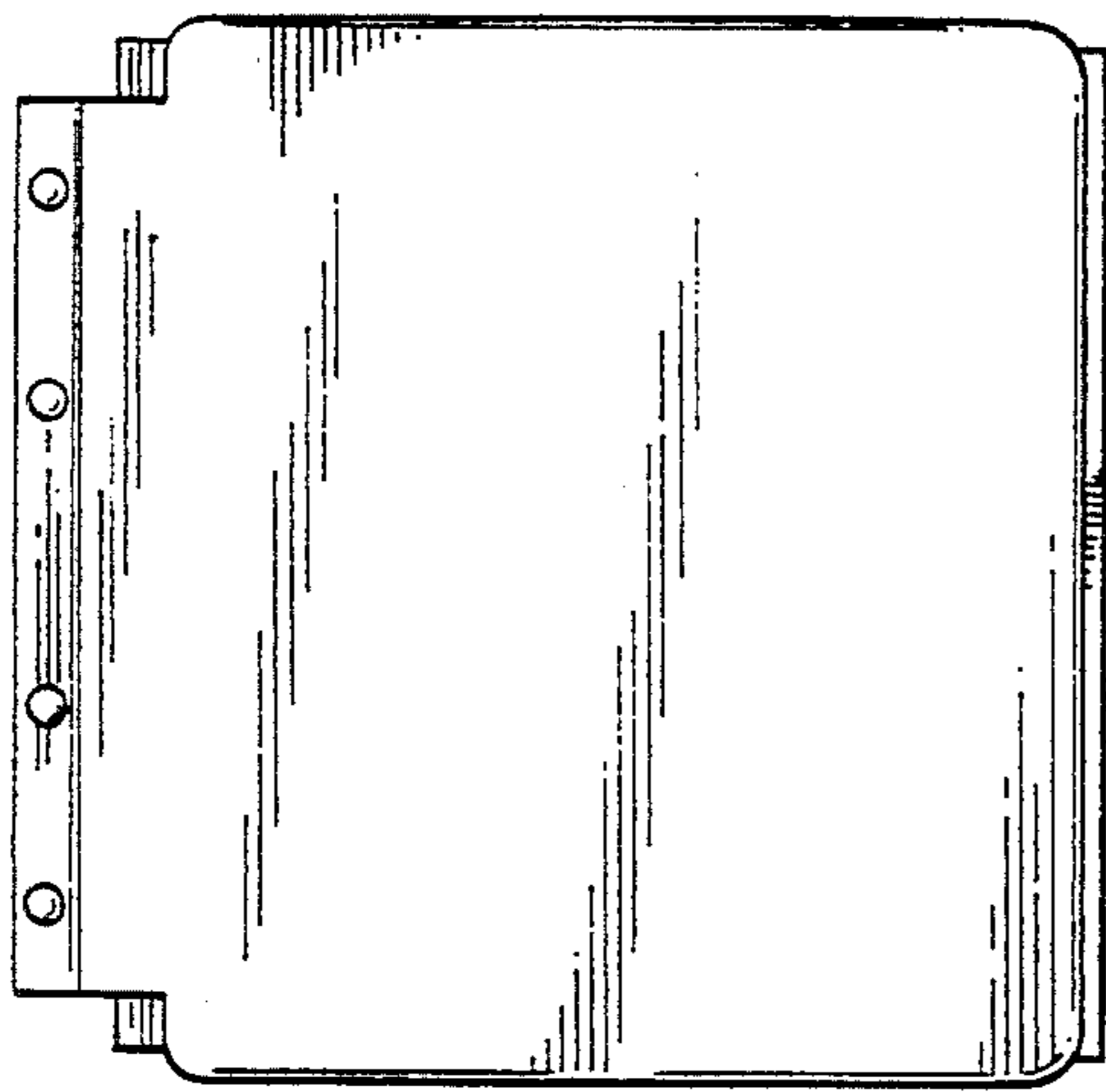

FIG. 5

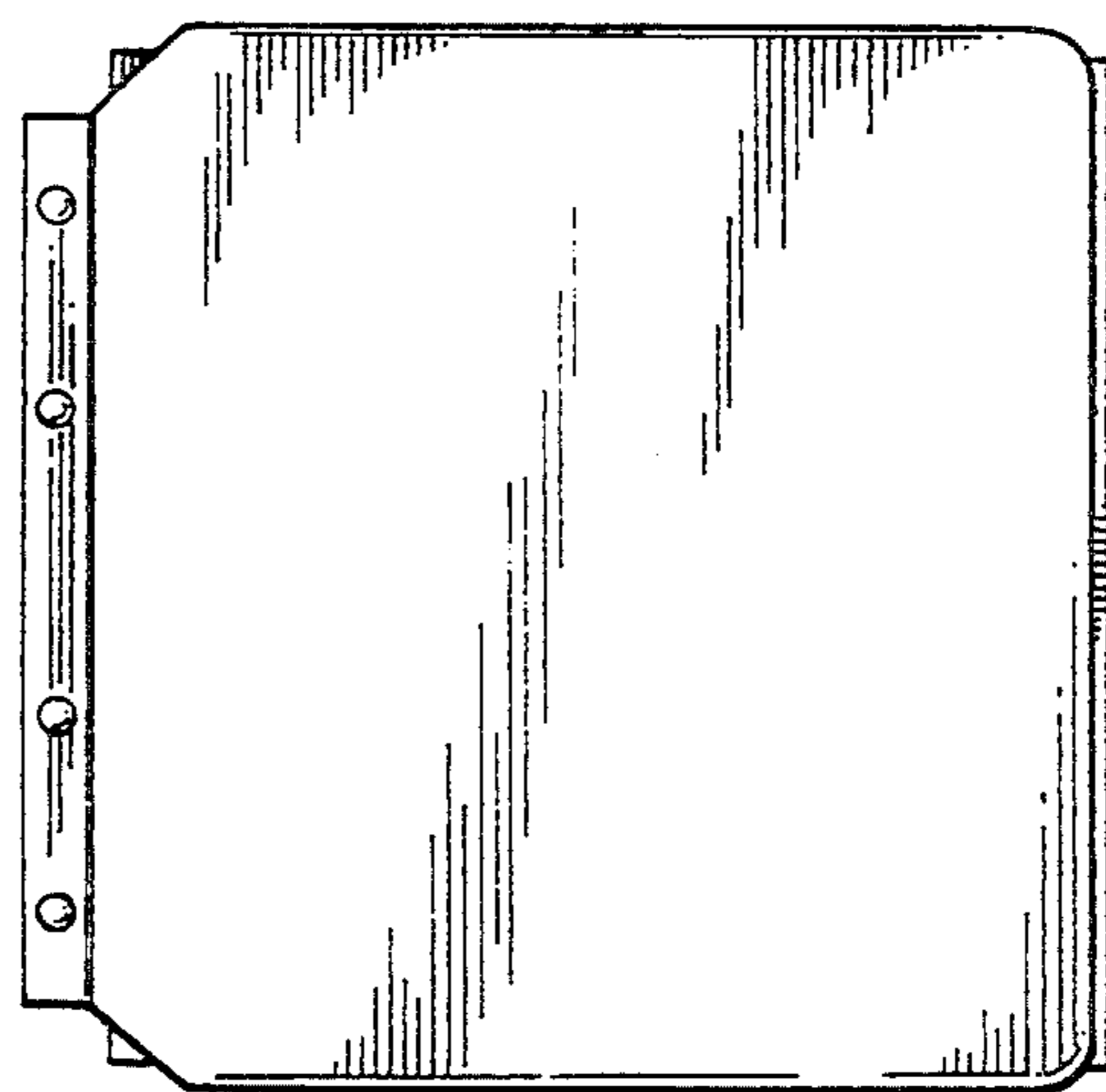

FIG. 6

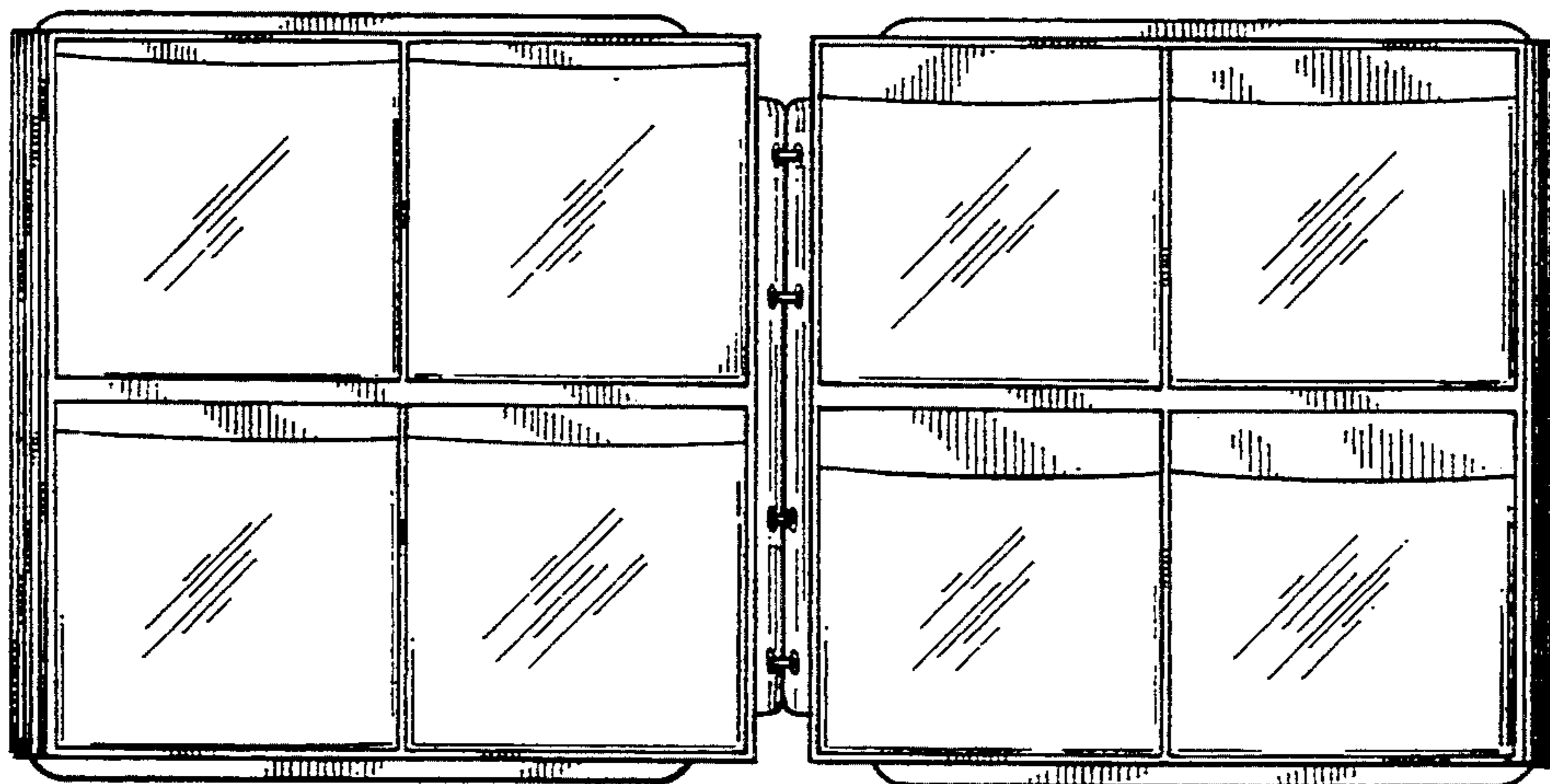

FIG. 7