



US00D360776S

United States Patent [19] Blue

[11] Patent Number: **Des. 360,776**

[45] Date of Patent: **** Aug. 1, 1995**

[54] **READING TRAY**

[76] Inventor: **Robin Blue**, 1919 N. 42nd Dr.,
Phoenix, Ariz. 85009

[**] Term: **14 Years**

[21] Appl. No.: **19,268**

[22] Filed: **Feb. 28, 1994**

[52] U.S. Cl. **D6/406**

[58] Field of Search D6/406, 419, 482, 511;
D12/415-425; D19/52, 90, 35; 108/43, 44, 47,
97, 99, 115; 211/88; D7/550, 553, 554, 698

3,364,884 1/1968 Hamilton et al. 108/115 X
4,010,696 3/1977 Priesman 108/44 X
4,341,164 7/1982 Johnson 108/115 X
4,700,731 10/1987 Smith 108/115 X
4,909,159 3/1990 Gonsoulin D6/406 X

Primary Examiner—Alan P. Douglas
Assistant Examiner—S. Snapp

[57] **CLAIM**

The ornamental design for a reading tray, as shown and described.

DESCRIPTION

FIG. 1 is a front elevational view of the reading tray showing my new design;
FIG. 2 is a rear elevational view thereof;
FIG. 3 is a left side elevational view thereof;
FIG. 4 is a right side elevational view thereof;
FIG. 5 is a top plan view thereof;
FIG. 6 is a bottom plan view thereof; and,
FIG. 7 is an isometric view thereof.

[56] **References Cited**

U.S. PATENT DOCUMENTS

D. 138,352 7/1944 Morando D6/406
D. 281,555 12/1985 Levy D6/406
D. 288,097 2/1987 Harter et al. D6/406 X
D. 289,247 4/1987 Wang D7/554 X
D. 319,358 8/1991 Giugiaro D6/406
2,039,922 5/1936 Neats 108/43 X

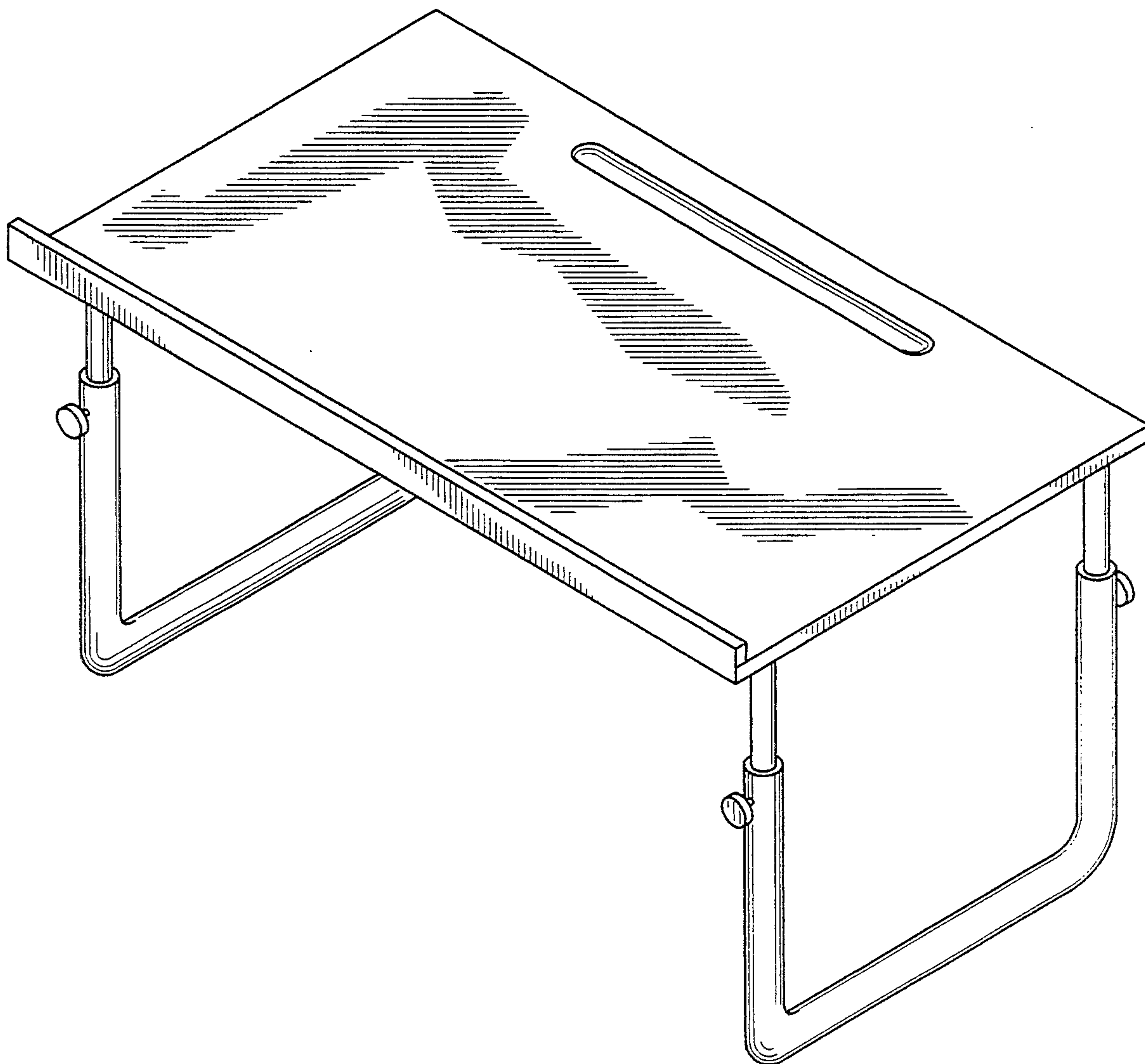

FIG. 1

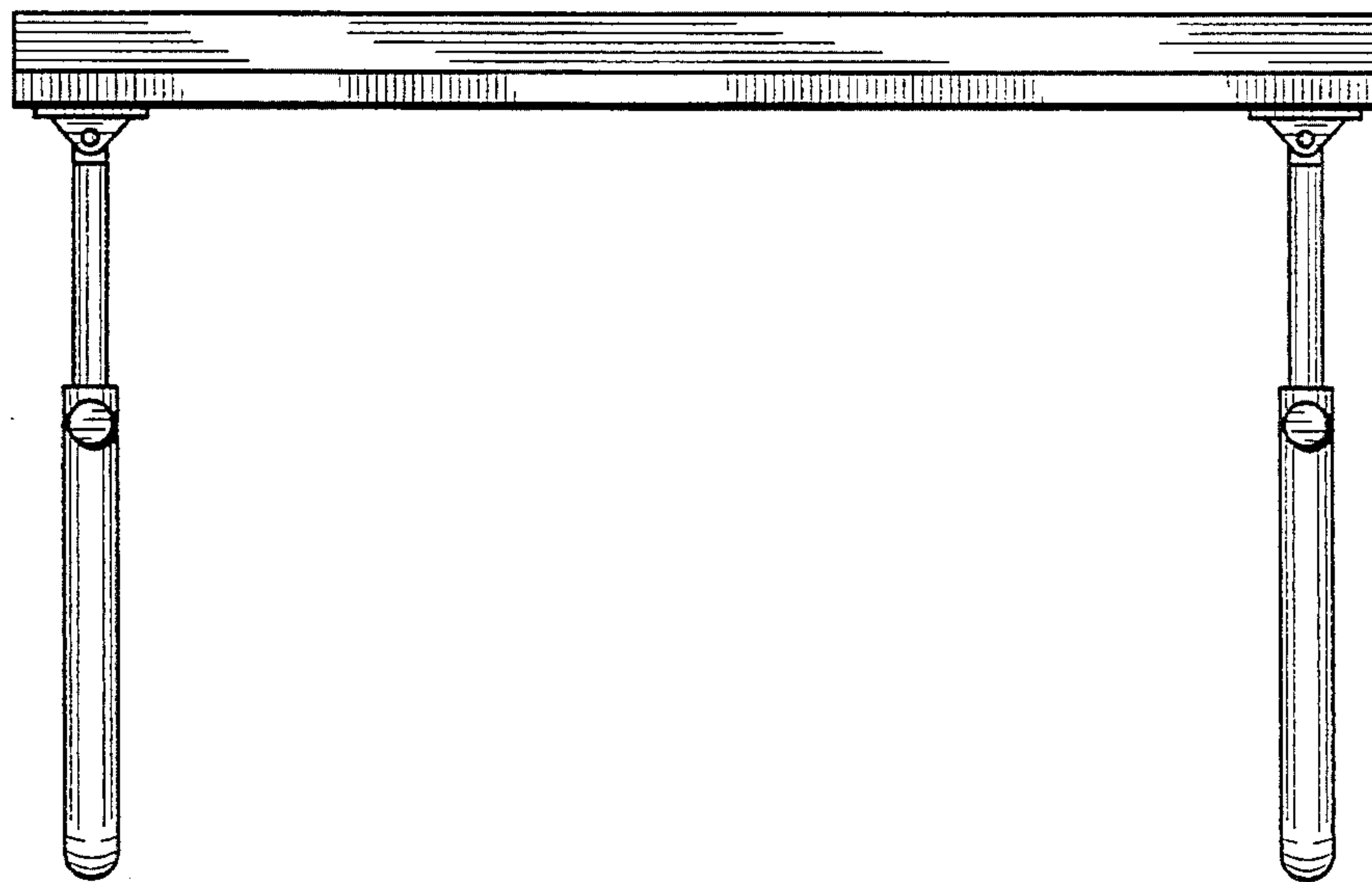

FIG. 2

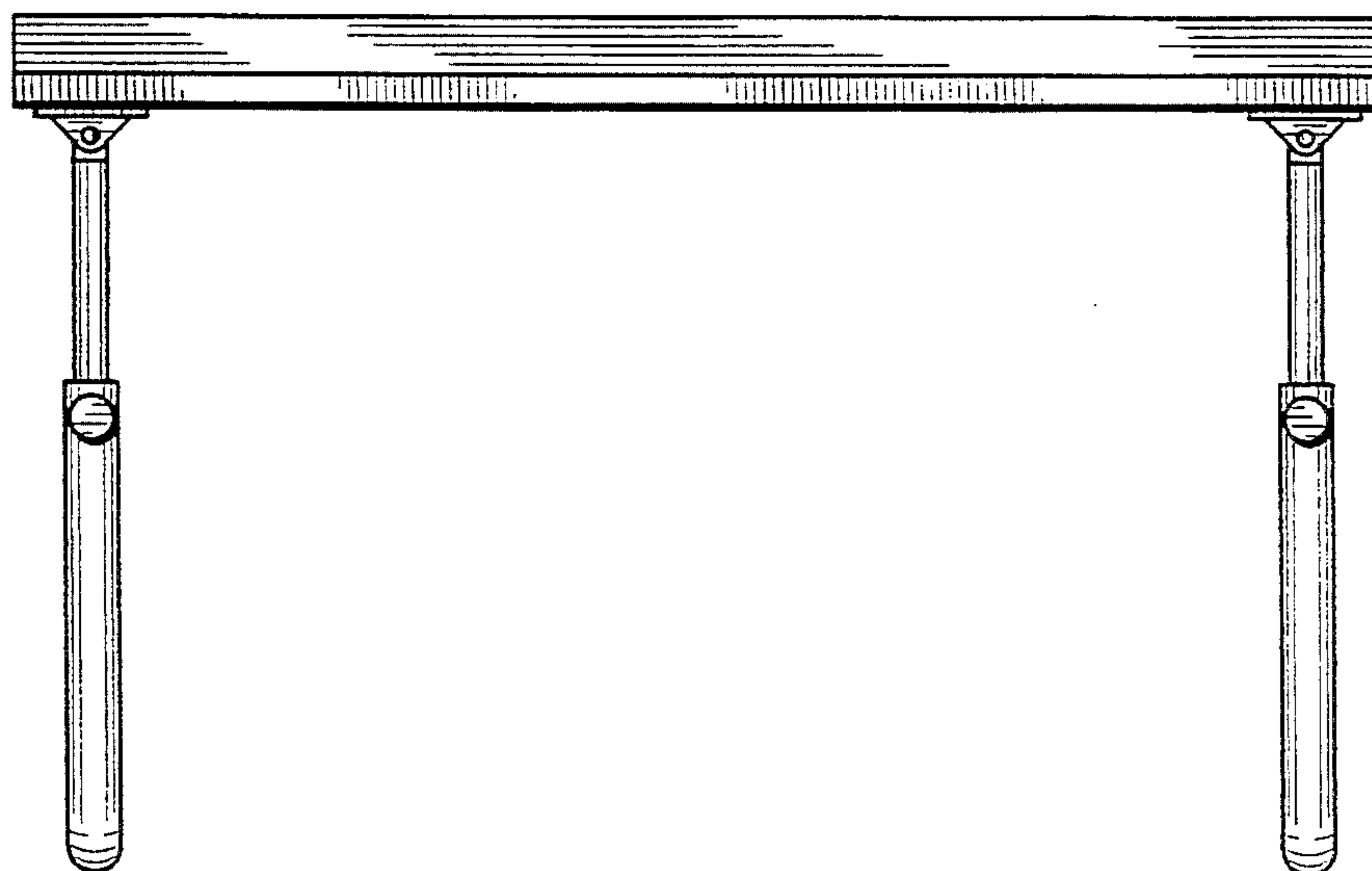

FIG. 3

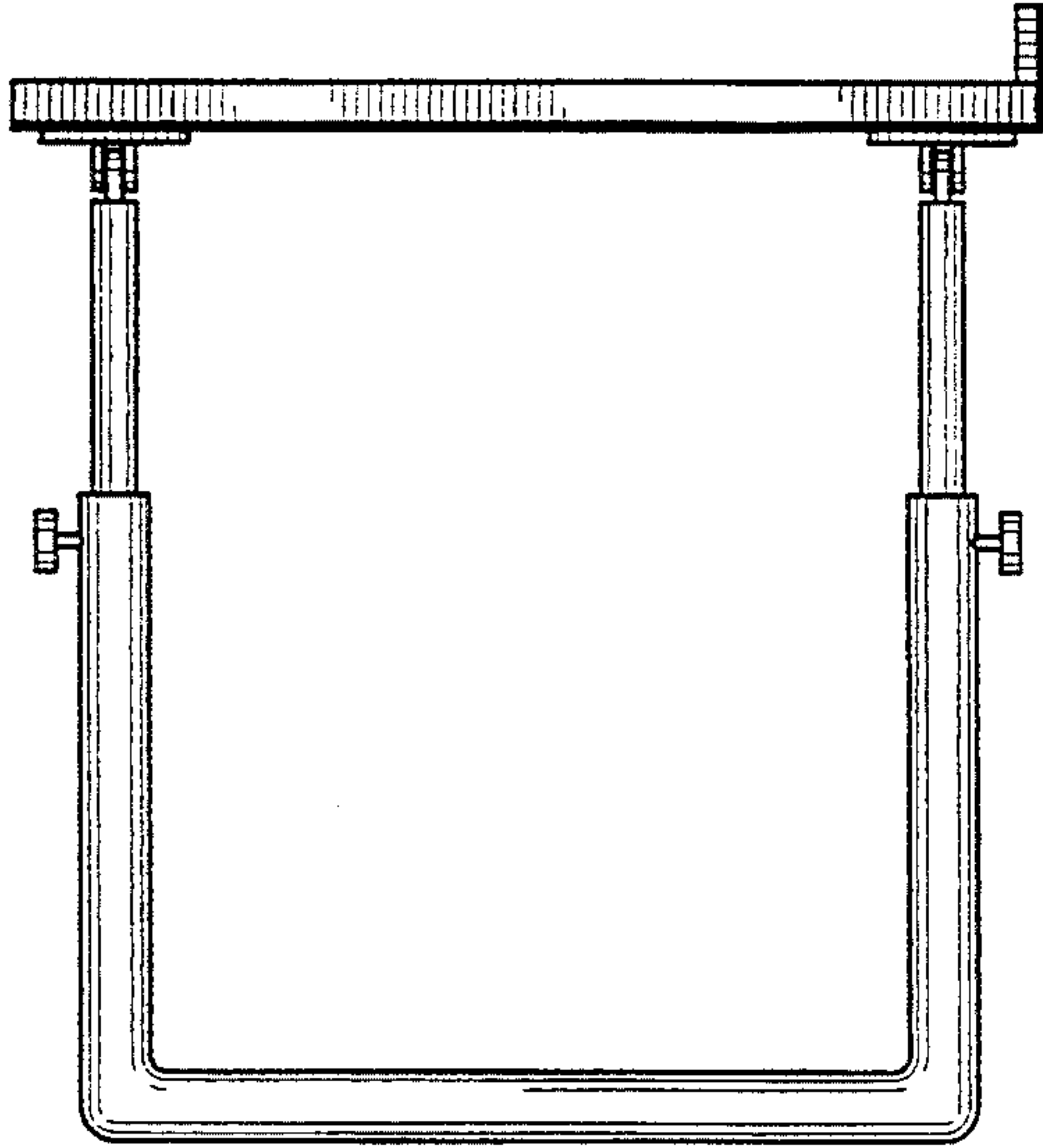

FIG. 4

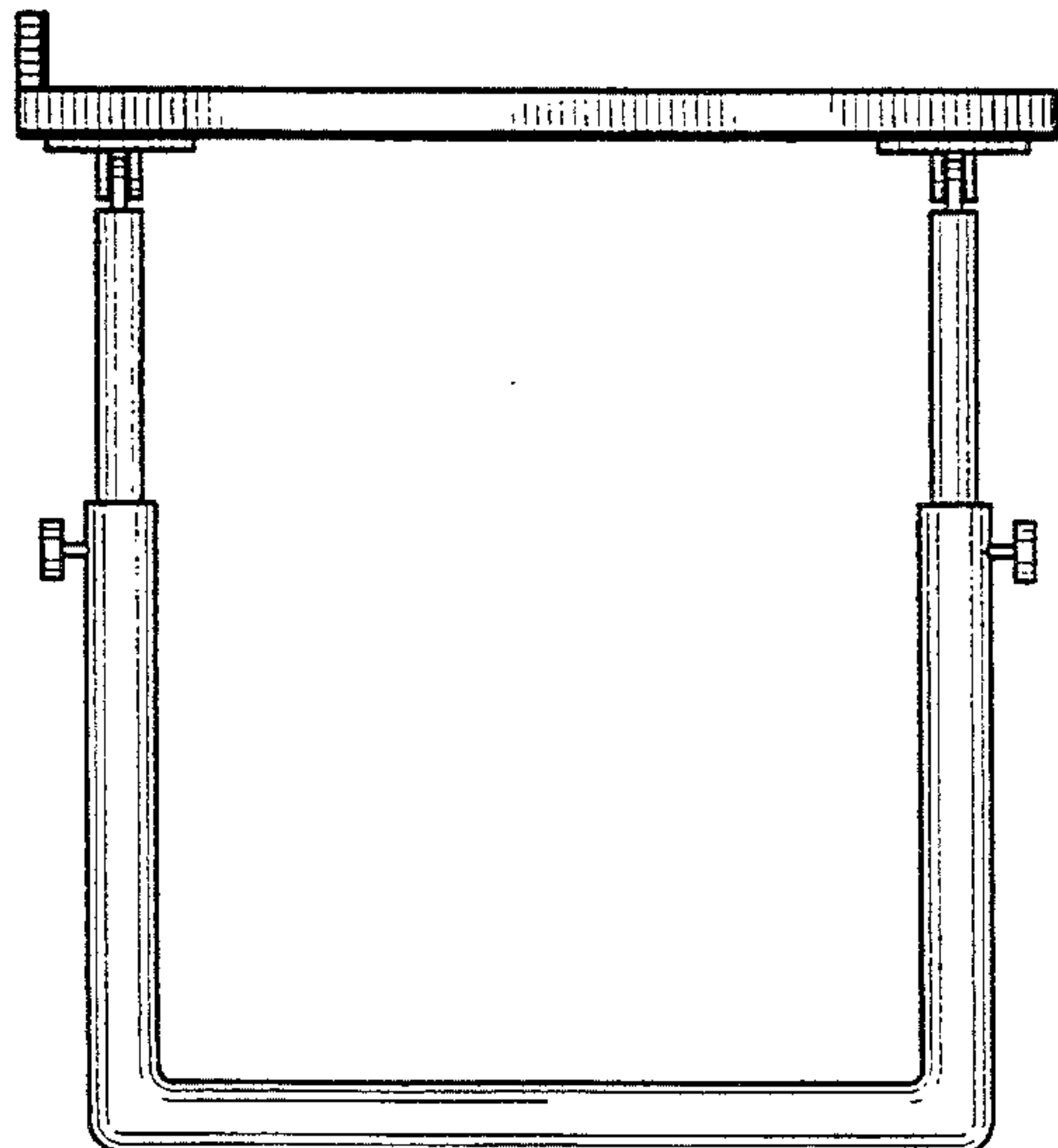

FIG. 5

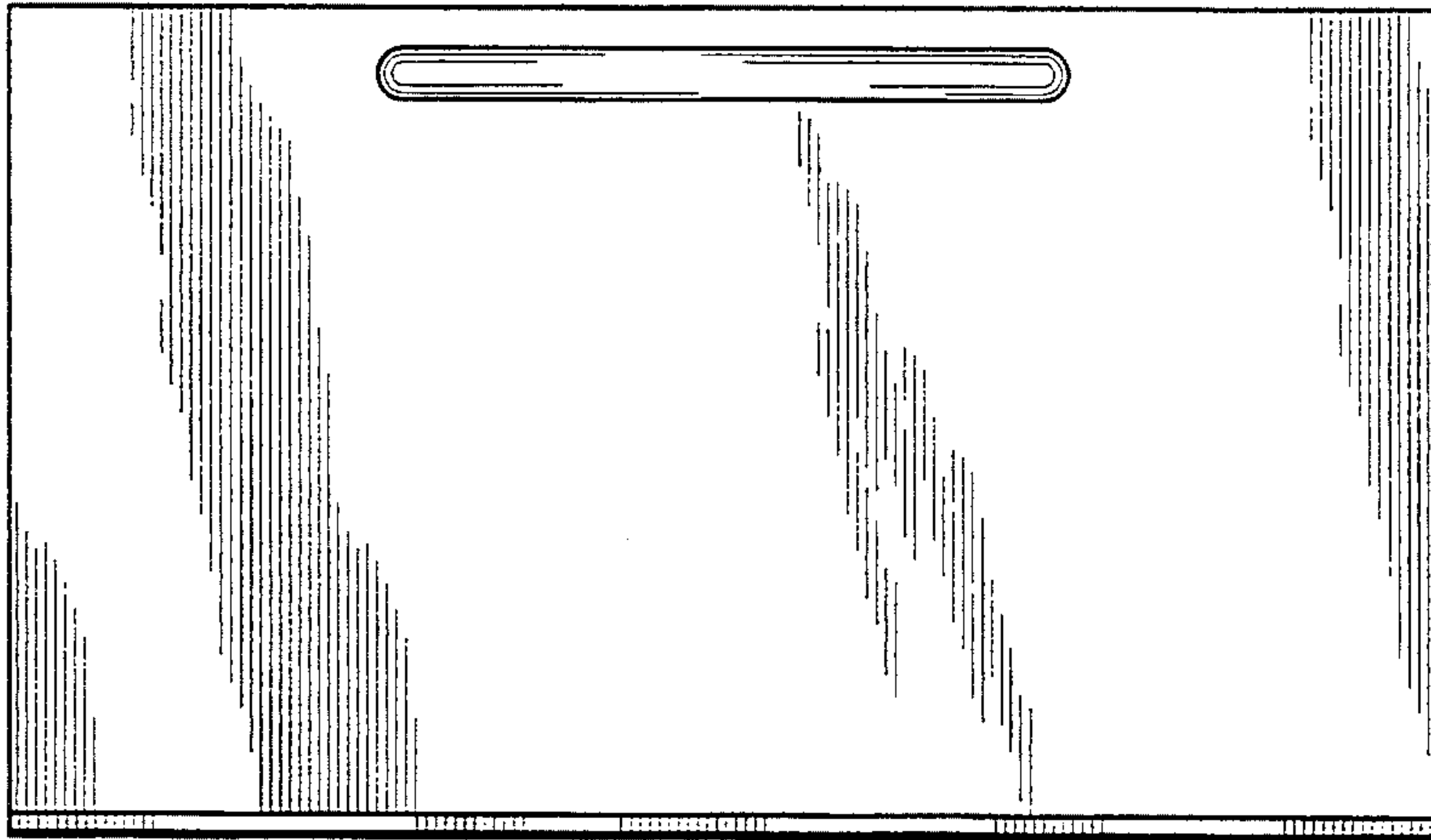

FIG. 6

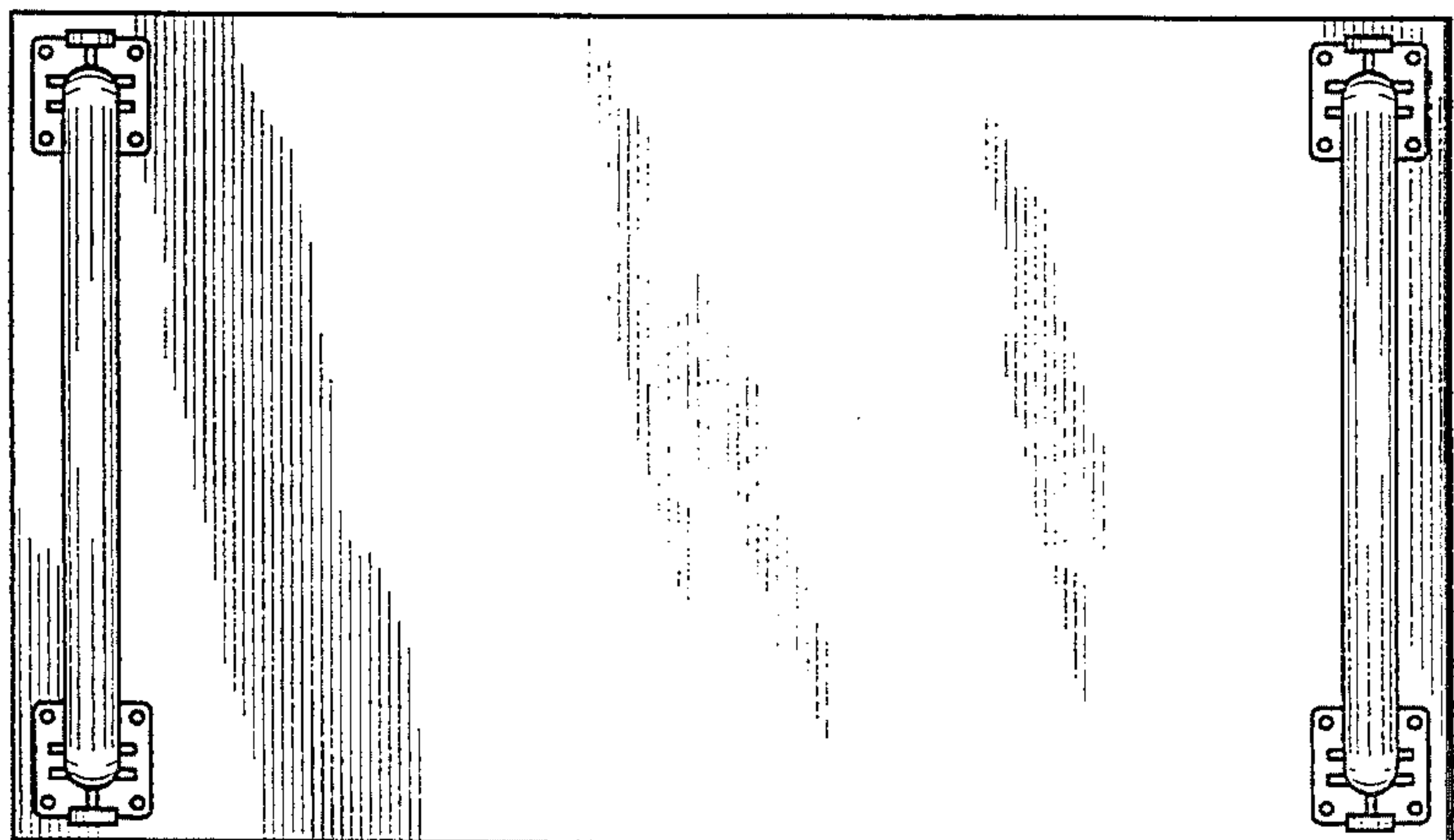

FIG. 7

