



US00D360717S

United States Patent [19]

Martin et al.

[11] Patent Number: **Des. 360,717**

[45] Date of Patent: **** Jul. 25, 1995**

[54] **VACUUM CLEANER**

[75] Inventors: **Michael F. Martin**, Bristol, Tenn.;
Duane M. Loose, Chelmsford; **David G. Honan**, Concord, both of Mass.;
William D. Starr, Bristol, Va.; **Peter Hoekstra**, Bristol, Tenn.

[73] Assignee: **Electrolux Corporation**, Atlanta, Ga.

[**] Term: **14 Years**

[21] Appl. No.: **22,787**

[22] Filed: **May 12, 1994**

[52] U.S. Cl. **D32/21**

[58] Field of Search **D32/21, 23-24;**
15/320-321, 323, 327.1, 327.2, 327.4, 353

[56] **References Cited**

U.S. PATENT DOCUMENTS

D. 272,570	2/1984	Van Dyken et al.	D32/21
D. 272,571	2/1984	Tarnowski et al.	D32/21
D. 285,619	9/1986	Nado et al.	D32/21
D. 296,944	7/1988	Yamamoto et al.	D32/21
D. 297,475	8/1988	Umehara et al.	D32/21
D. 297,675	9/1988	Umehara et al.	D32/21
D. 311,614	10/1990	Hirano et al.	D32/21
D. 315,041	2/1991	Bradd	D32/21
D. 325,274	4/1992	Ikeda	D32/21

D. 343,931	2/1994	Tsuruha et al.	D32/21
D. 346,678	5/1994	Burkhardt	D32/21
2,498,063	2/1950	Binggely	183/49
3,082,938	3/1963	Mott, Jr.	230/233
3,344,588	10/1967	Szabo	55/276
3,466,696	9/1969	Grellsson	15/327
4,114,231	9/1978	Nauta	15/413
4,533,370	8/1985	Ikezaki et al.	55/276
4,617,034	10/1986	Ikezaki et al.	55/276
4,970,753	11/1990	Herron, Jr.	15/326
5,159,738	11/1992	Sunagawa et al.	15/326
5,214,822	6/1993	Sakurai et al.	15/326

Primary Examiner—Ruth McInroy
Attorney, Agent, or Firm—Fish & Neave; Jeffrey H. Ingerman

[57] **CLAIM**

The ornamental design for a vacuum cleaner, a shown and described.

DESCRIPTION

FIG. 1 is a front, right, top perspective view of a vacuum cleaner, showing our new design;
FIG. 2 is a top plan view thereof;
FIG. 3 is a right side elevational view thereof;
FIG. 4 is a front elevational view thereof;
FIG. 5 is a rear elevational view thereof;
FIG. 6 is a left side elevational view thereof; and,
FIG. 7 is a bottom plan view thereof.

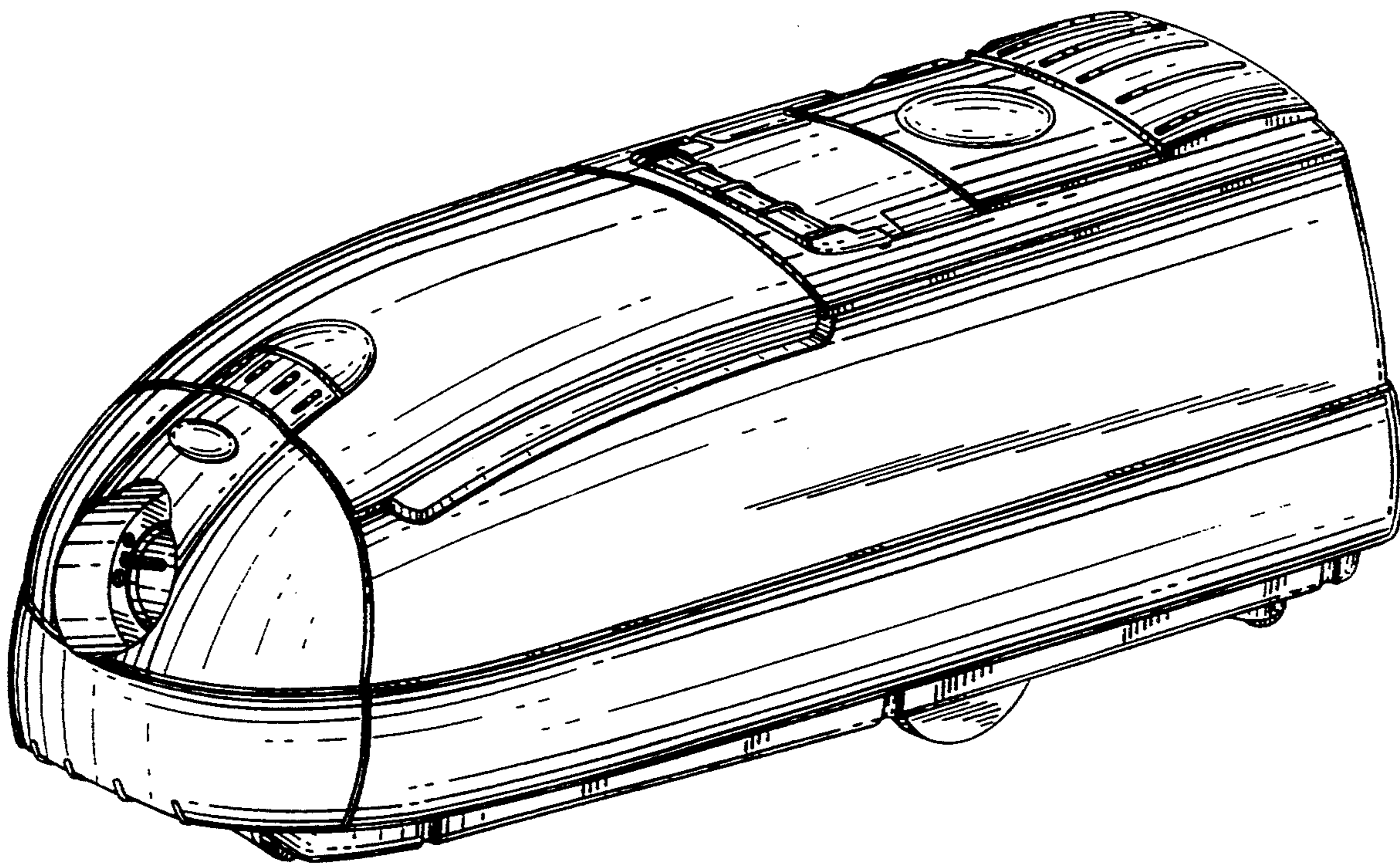

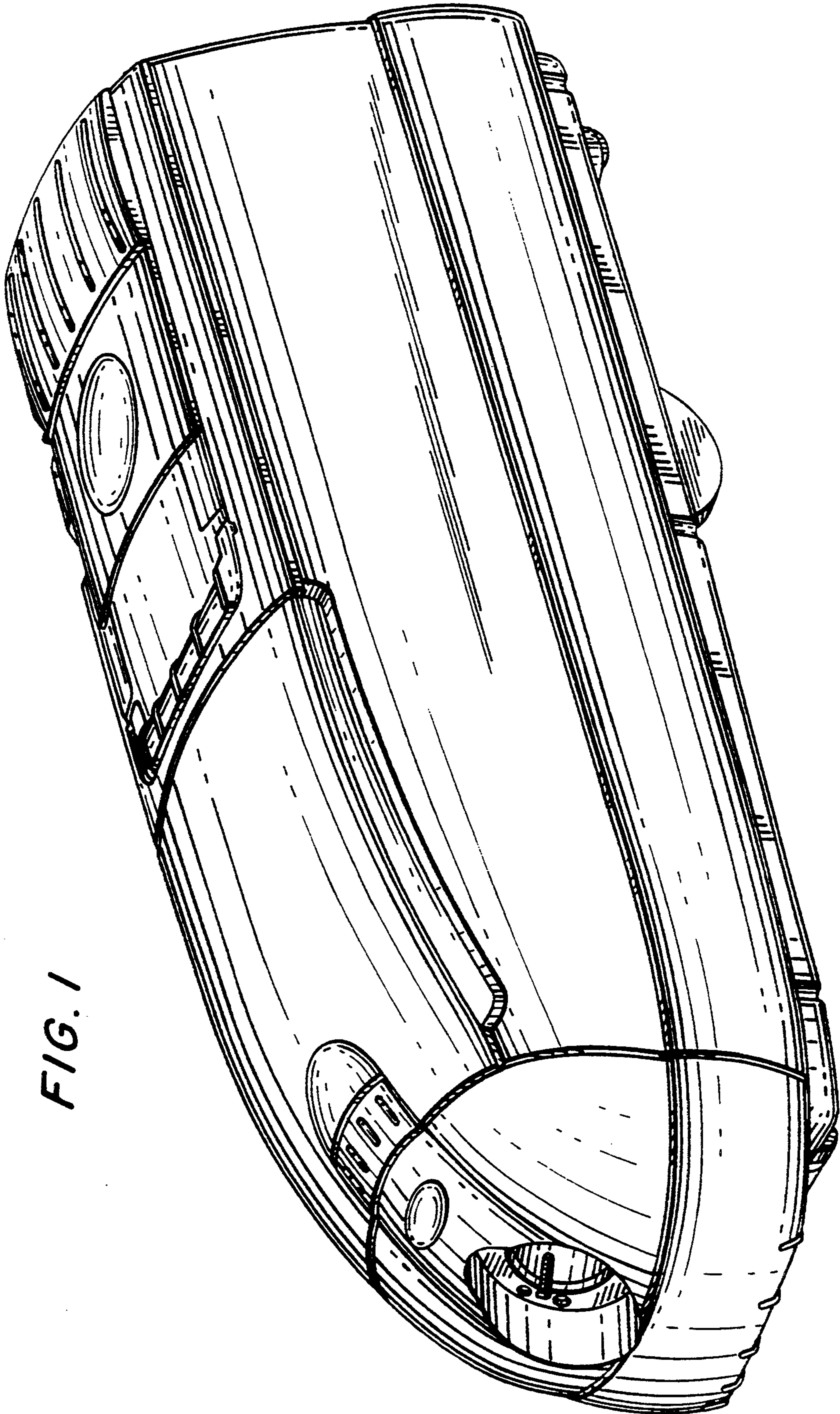

FIG. 1

FIG. 2

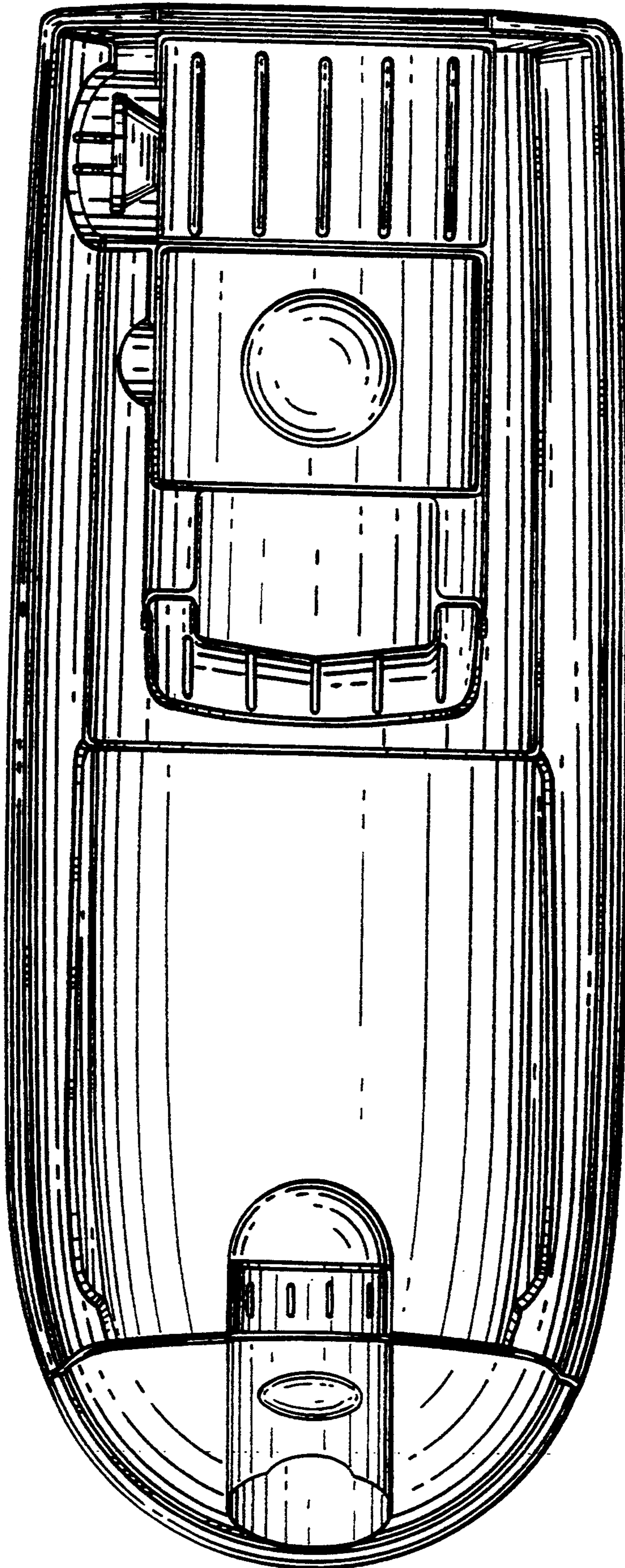

FIG. 3

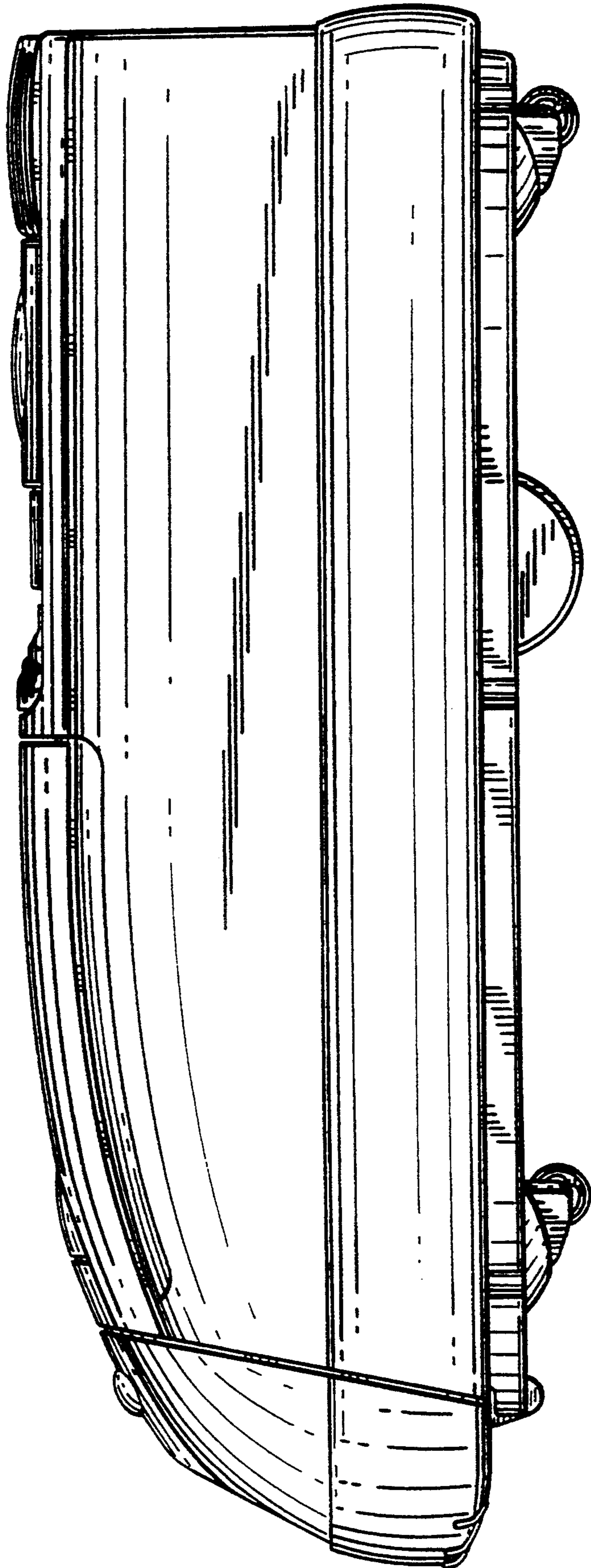

FIG. 5

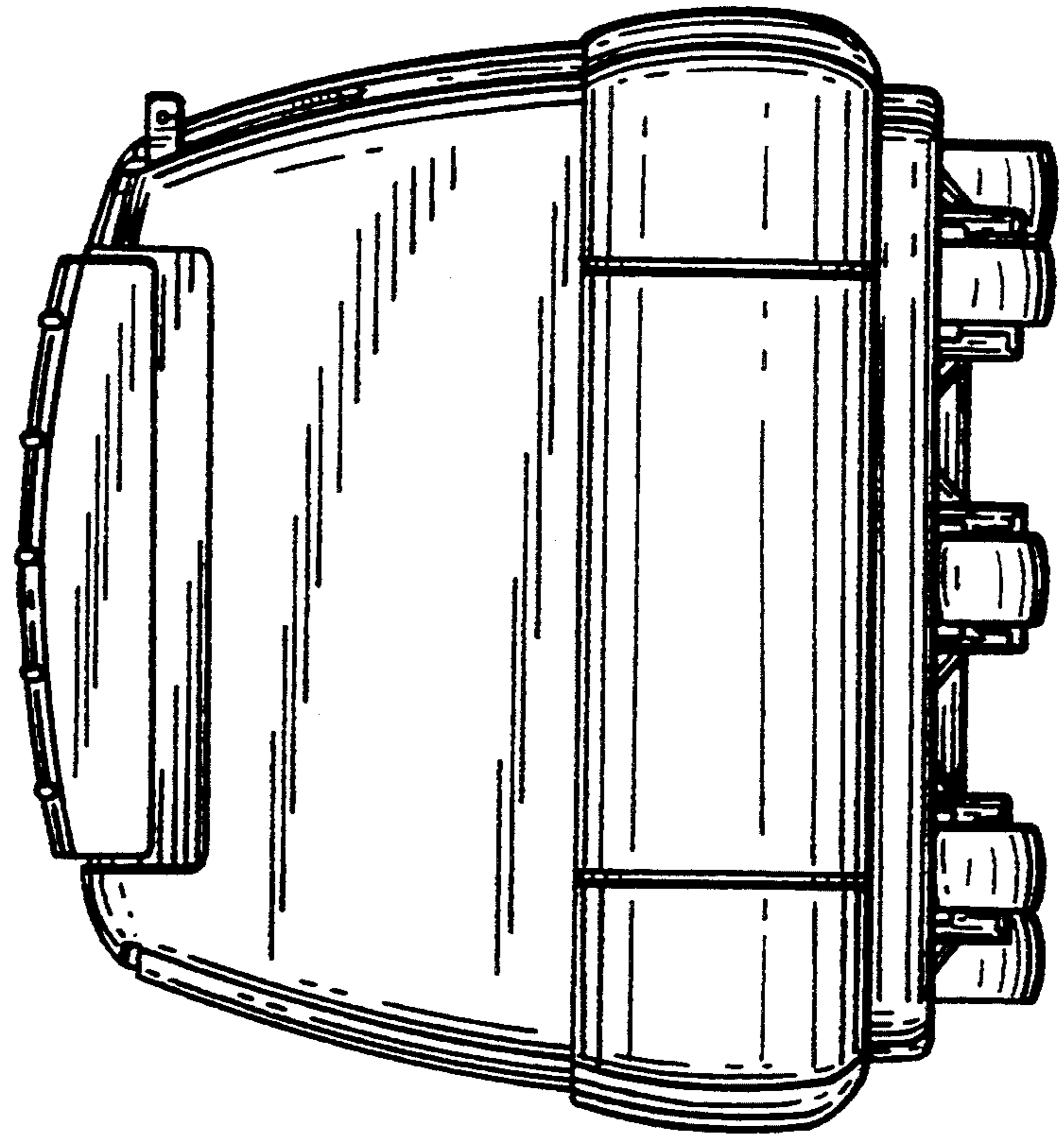

FIG. 4

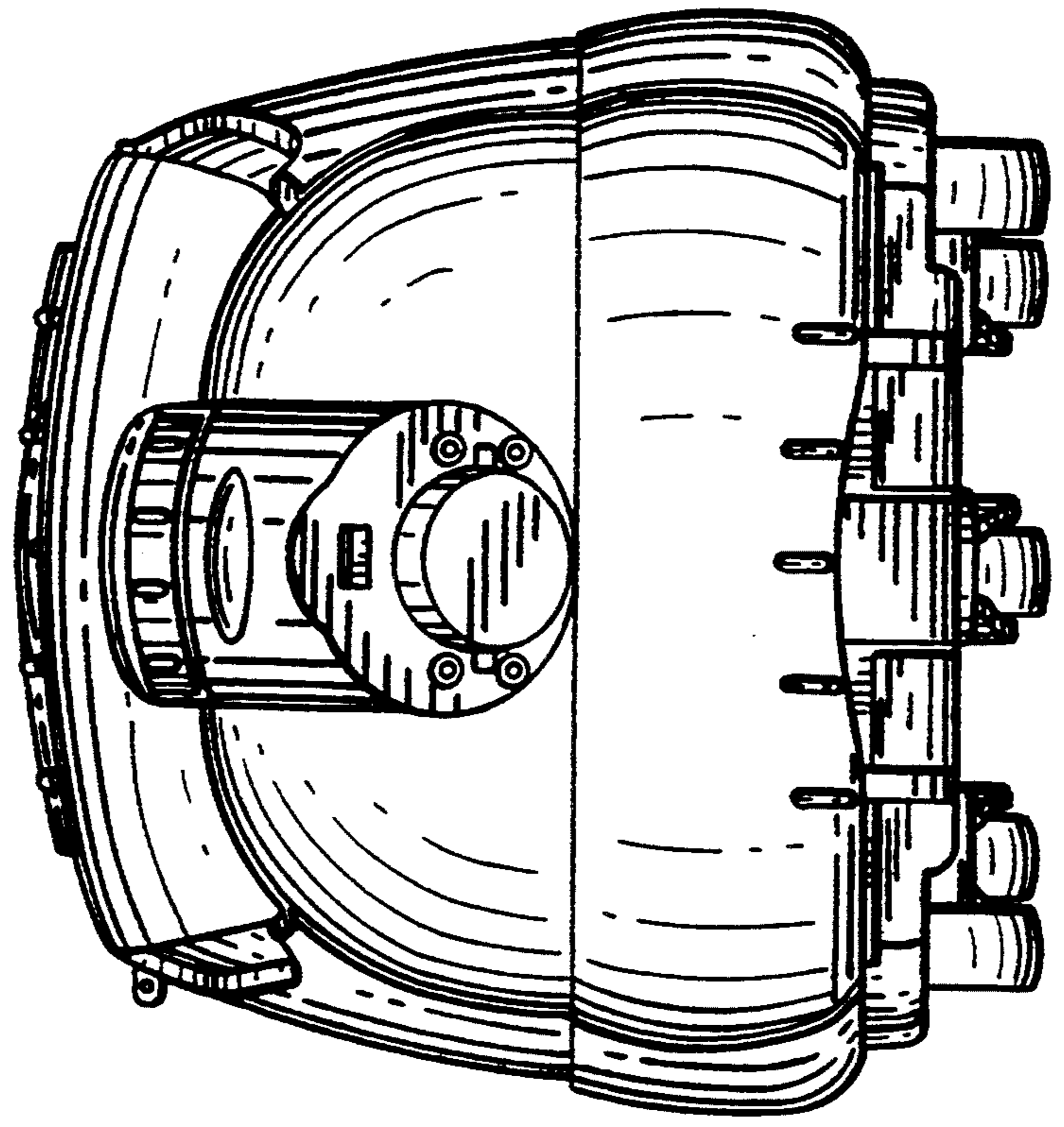

FIG. 6

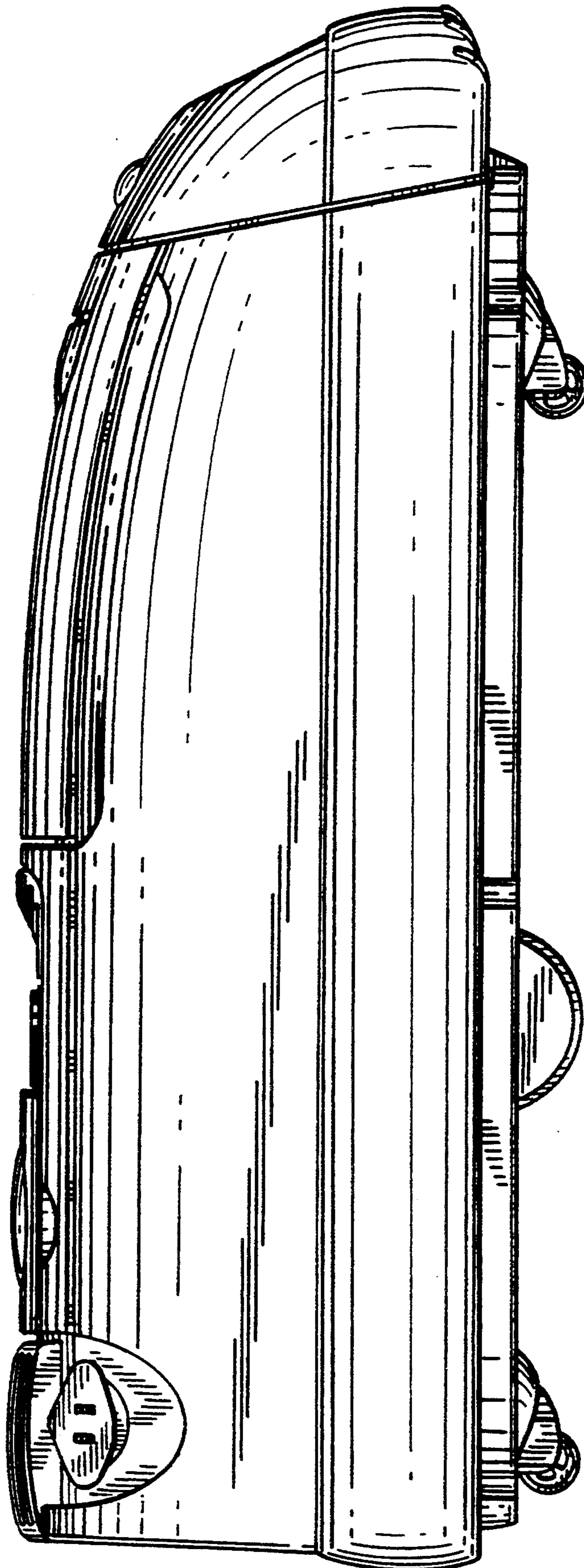

FIG. 7

