



US00D360592S

United States Patent [19]

[11] Patent Number: **Des. 360,592**

Wermekes

[45] Date of Patent: **** Jul. 25, 1995**

[54] SANDWICH WATCH

Attorney, Agent, or Firm—Anderson Kill Olick & Oshinsky

[75] Inventor: **Günter Wermekes**, Dusseldorf, Germany

[57] **CLAIM**

[73] Assignee: **Gebrüder Niessing GmbH & Co.**, Vreden, Germany

The ornamental design for a sandwich watch, as shown and described.

[**] Term: **14 Years**

DESCRIPTION

[21] Appl. No.: **10,760**

FIG. 1 is a perspective view showing the top and left side of the watch design, together with a portion of the wristband, of the sandwich watch according to my new design;

[22] Filed: **Jul. 19, 1993**

[52] U.S. Cl. **D10/32; D10/30**

FIG. 2 is a top plan view of the watch design, together with a portion of the wristband, shown in FIG. 1;

[58] Field of Search **D10/30, 32, 39, 22, D10/39; D11/4; 63/3; 368/280, 281, 282**

FIG. 3 is a perspective view showing the bottom and right side of the watch design, together with a portion of the wrist band, shown in FIG. 1;

[56] **References Cited**

U.S. PATENT DOCUMENTS

D. 279,552	7/1985	Maglioli	D10/39
D. 288,669	3/1987	Maron	D10/30
4,034,552	6/1977	Dandson	D10/32
4,942,755	7/1990	Gogniat	368/280

FIG. 4 is a perspective view showing the top and right side of the watch design without the wristband;

OTHER PUBLICATIONS

Timepieces, 6/1989, p. 155.

Swiss Watch & Jewelry Journal, 2/1980 p. 174.

FIG. 5 is a perspective view showing the top, right side and also showing one end which is the same as the other end of the watch design without the wristband;

Primary Examiner—Alan P. Douglas

Assistant Examiner—Cathron B. Matta

FIG. 6 is an exploded perspective view showing the entire sandwich watch and according to my new design;

FIG. 7 is a view similar to that of FIG. 1 but showing the entire sandwich watch; and,

FIG. 8 is a view similar to that of FIG. 3 but showing the entire sandwich watch.

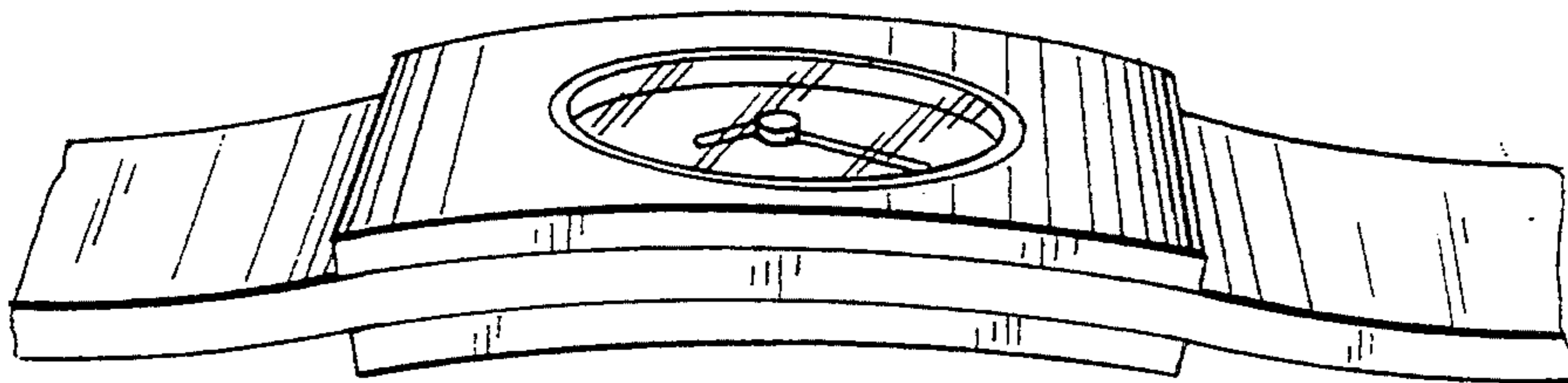

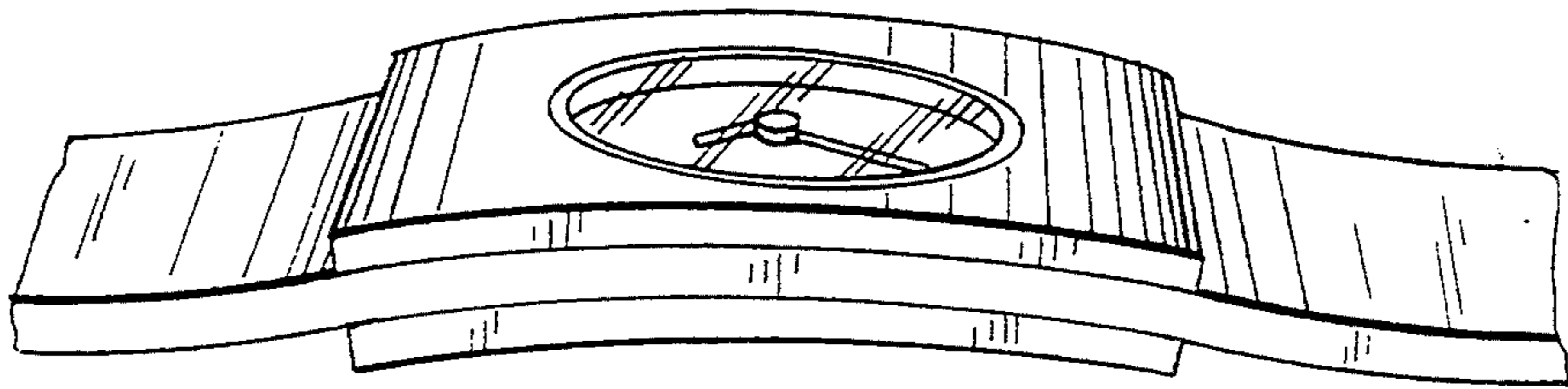

FIG. 1

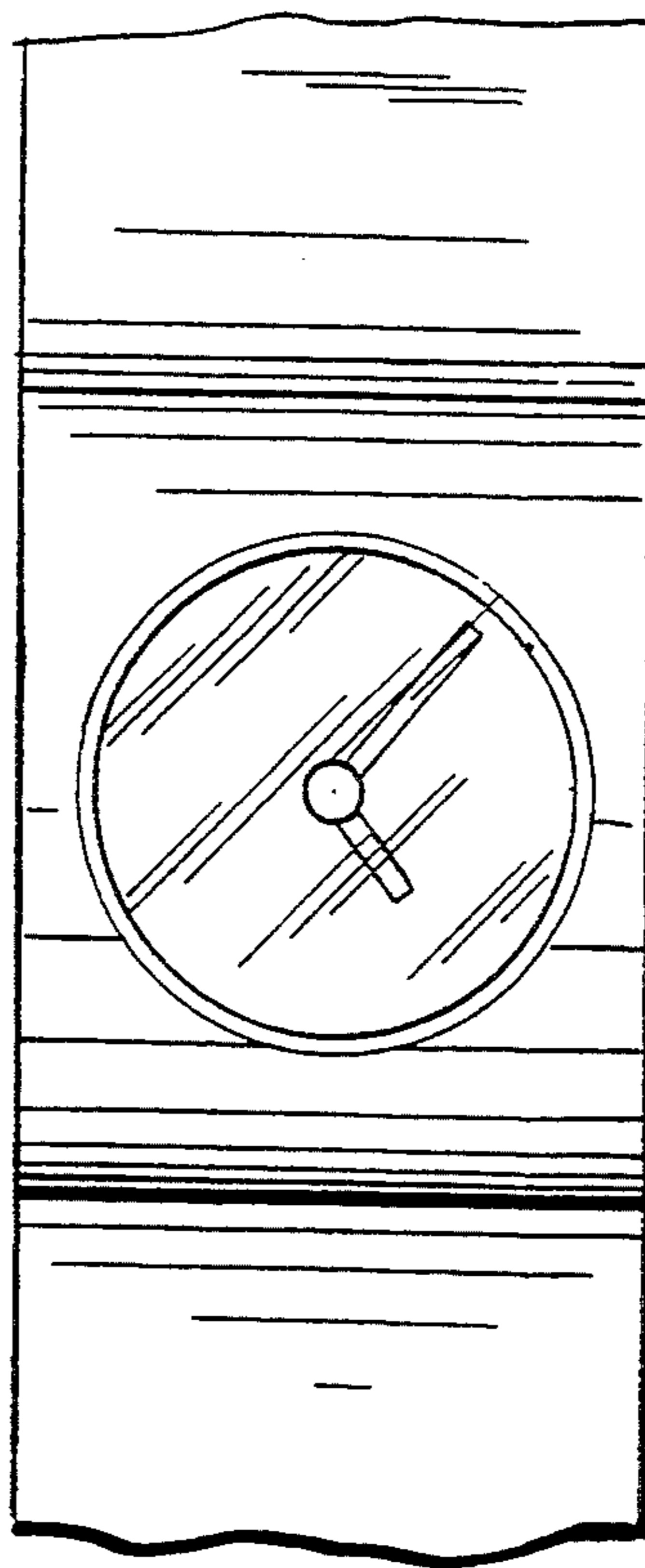

FIG. 2

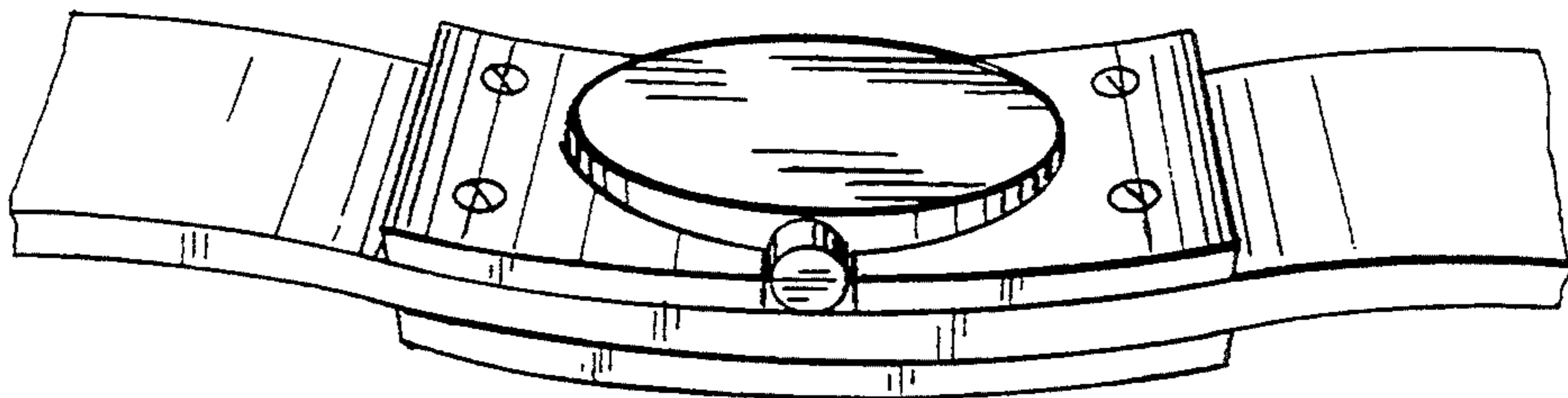

FIG. 3

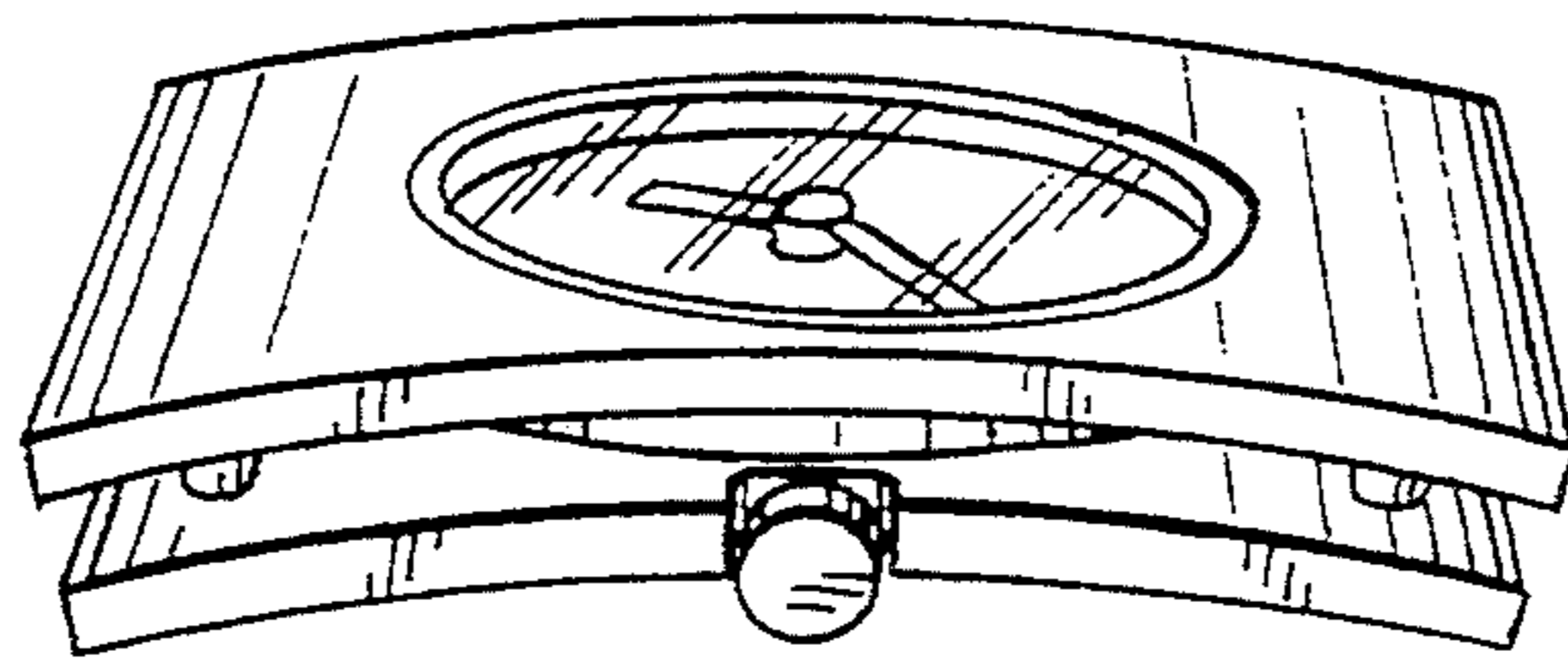

FIG. 4

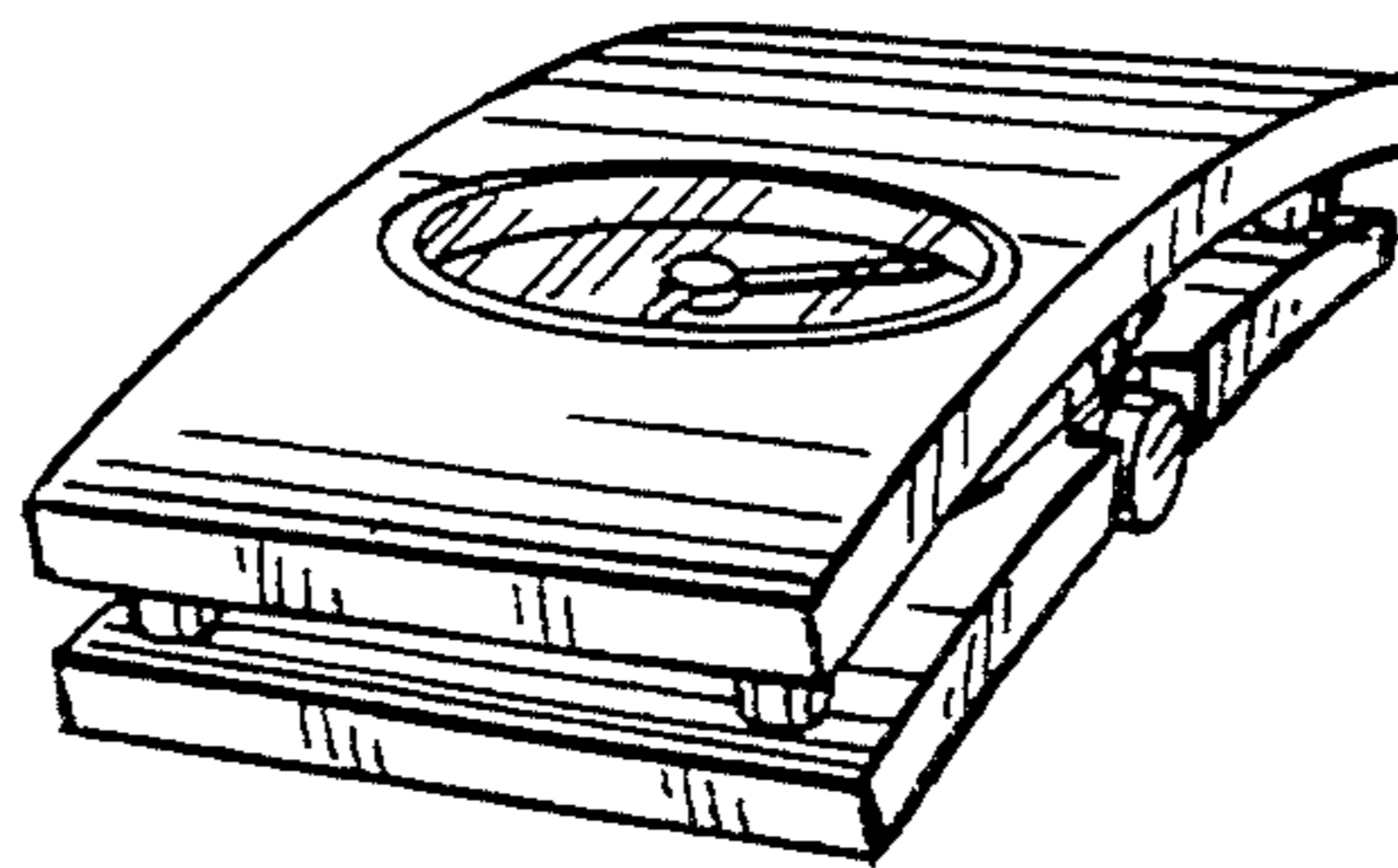

FIG. 5

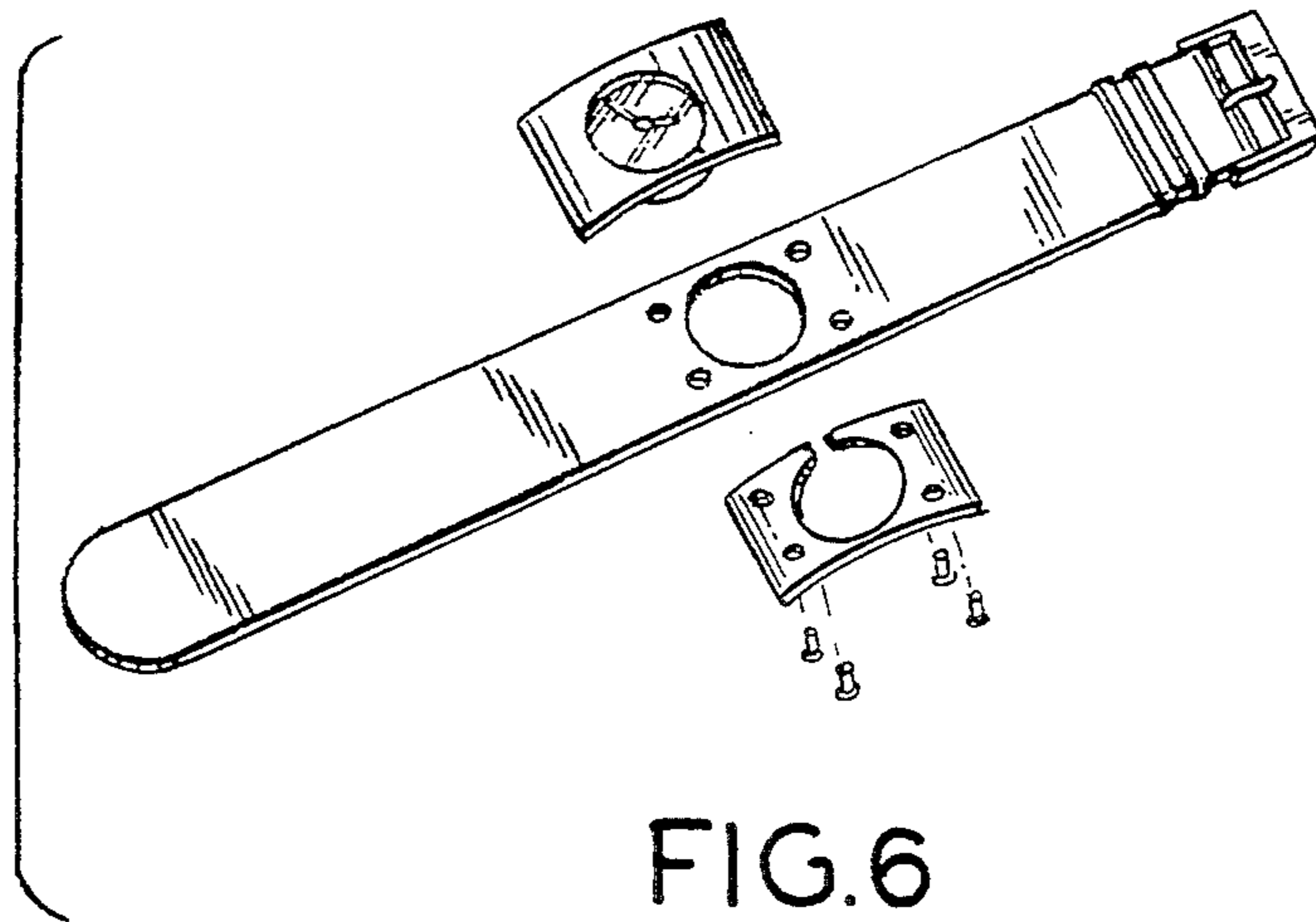

FIG. 6

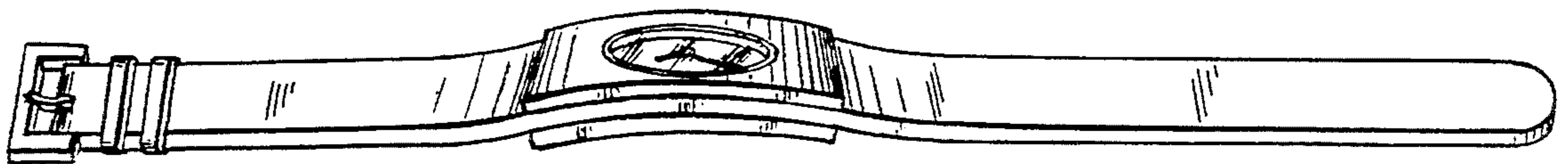

FIG. 7

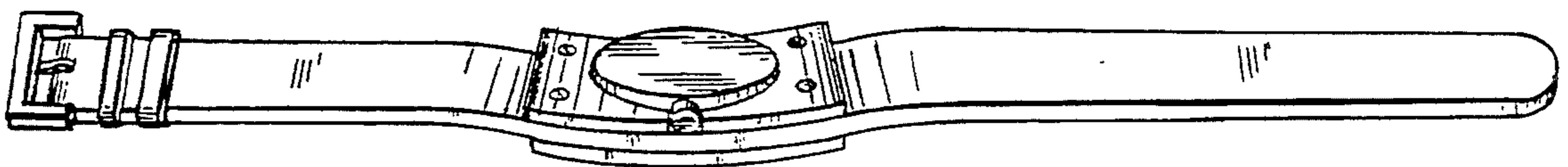

FIG. 8