



US00D360558S

United States Patent [19]

[11] Patent Number: Des. 360,558

Appleman

[45] Date of Patent: ** Jul. 25, 1995

- [54] DRINKING CUP WITH A SPIRAL STRAW
- [76] Inventor: James D. Appleman, 1742 N. Blair St., Philadelphia, Pa. 19125
- [**] Term: 14 Years
- [21] Appl. No.: 768
- [22] Filed: Oct. 26, 1992
- [52] U.S. Cl. D7/507; D7/509; D7/300.2
- [58] Field of Search D7/505, 506, 507, 509, D7/510, 511, 512, 514, 515, 529, 532, 533, 300.2; 220/710, 705, 771, 716, 719

Primary Examiner—Martie Thompson
Assistant Examiner—M. N. Pandozzi

[57] CLAIM

The ornamental design for a drinking cup with a spiral straw, as shown and described.

DESCRIPTION

FIG. 1 is a front elevation view of a drinking cup with a spiral straw embodying my invention;
 FIG. 2 is rear elevation view of a drinking cup with a spiral straw embodying my invention as shown in FIG. 1;
 FIG. 3 is a left side elevation view of a drinking cup with a spiral straw embodying my invention as shown in FIGS. 1 and 2;
 FIG. 4 is a right side elevation view of a drinking cup with a spiral straw embodying my invention as shown in FIGS. 1, 2 and 3;
 FIG. 5 is a top view of a drinking cup with a spiral straw embodying my invention as shown in FIGS. 1, 2, 3 and 4;
 FIG. 6 is a bottom view of a drinking cup with a spiral straw embodying my invention as shown in FIGS. 1, 2, 3, 4 and 5; and,
 FIG. 7 is an isometric view of a drinking cup with a spiral straw embodying my invention as shown in FIGS. 1, 2, 3, 4, 5 and 6.
 The straw has been shaded to show color contrast.

- [56] References Cited
- U.S. PATENT DOCUMENTS
- D. 279,250 6/1985 Holloway D7/507
- D. 330,993 11/1992 Robbins, III D7/510
- D. 337,187 7/1993 Hampshire D7/509 X
- 2,012,113 8/1935 Thompson D7/511 X
- 2,557,411 6/1951 Butsch 220/705 X
- 2,750,768 6/1956 Laurent 220/771 X
- 2,861,716 11/1958 Kramer D7/509 X
- 3,606,156 9/1971 Homorodean et al. 220/705 X
- 4,428,490 1/1984 Holloway 220/705 X
- 4,607,755 8/1986 Anpreozzi 220/710 X
- 5,253,780 10/1993 Adado 220/719 X

OTHER PUBLICATIONS

Vase (far left) by Nanny Still, Domus Oct. 1960, p. 18.

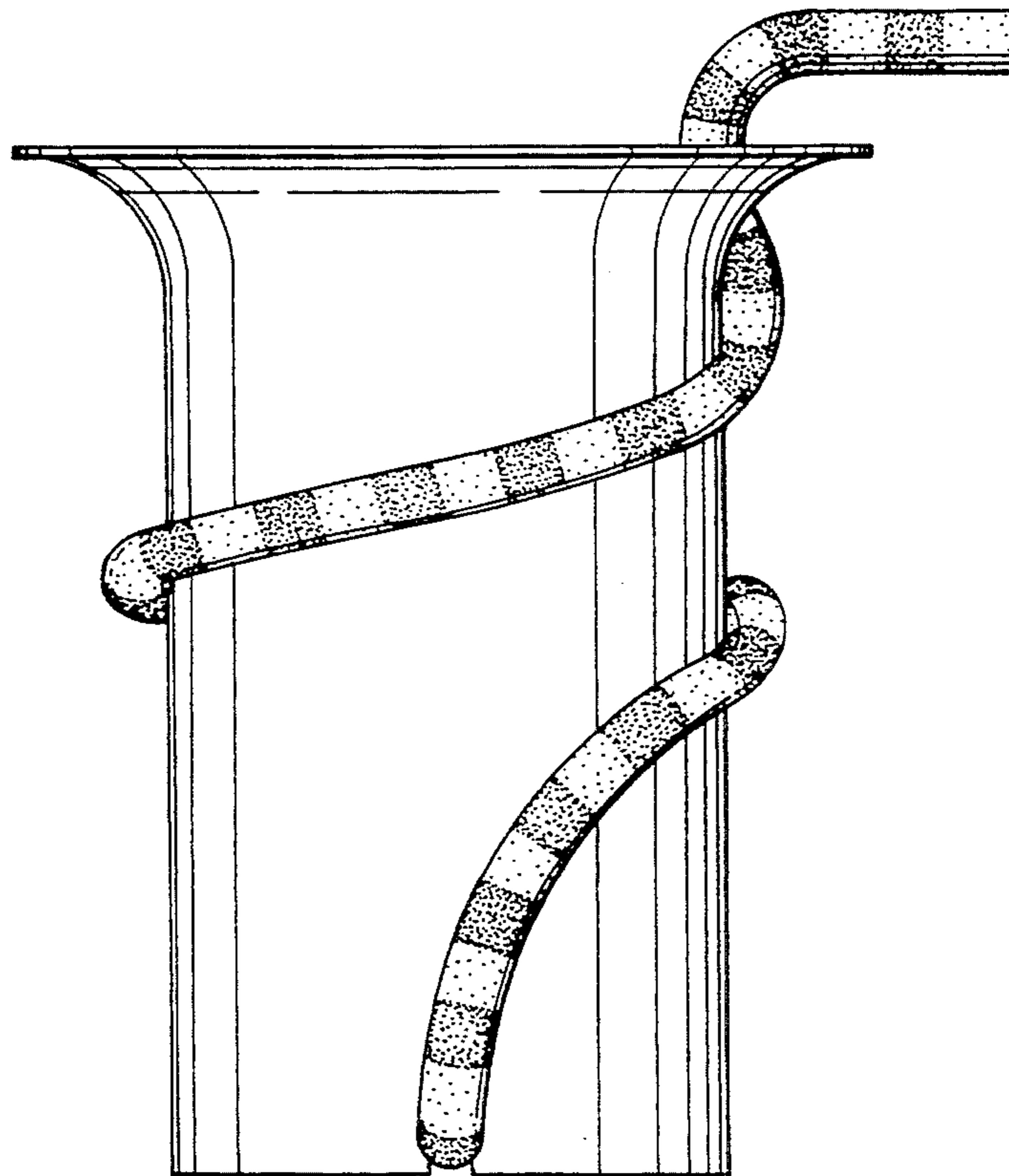

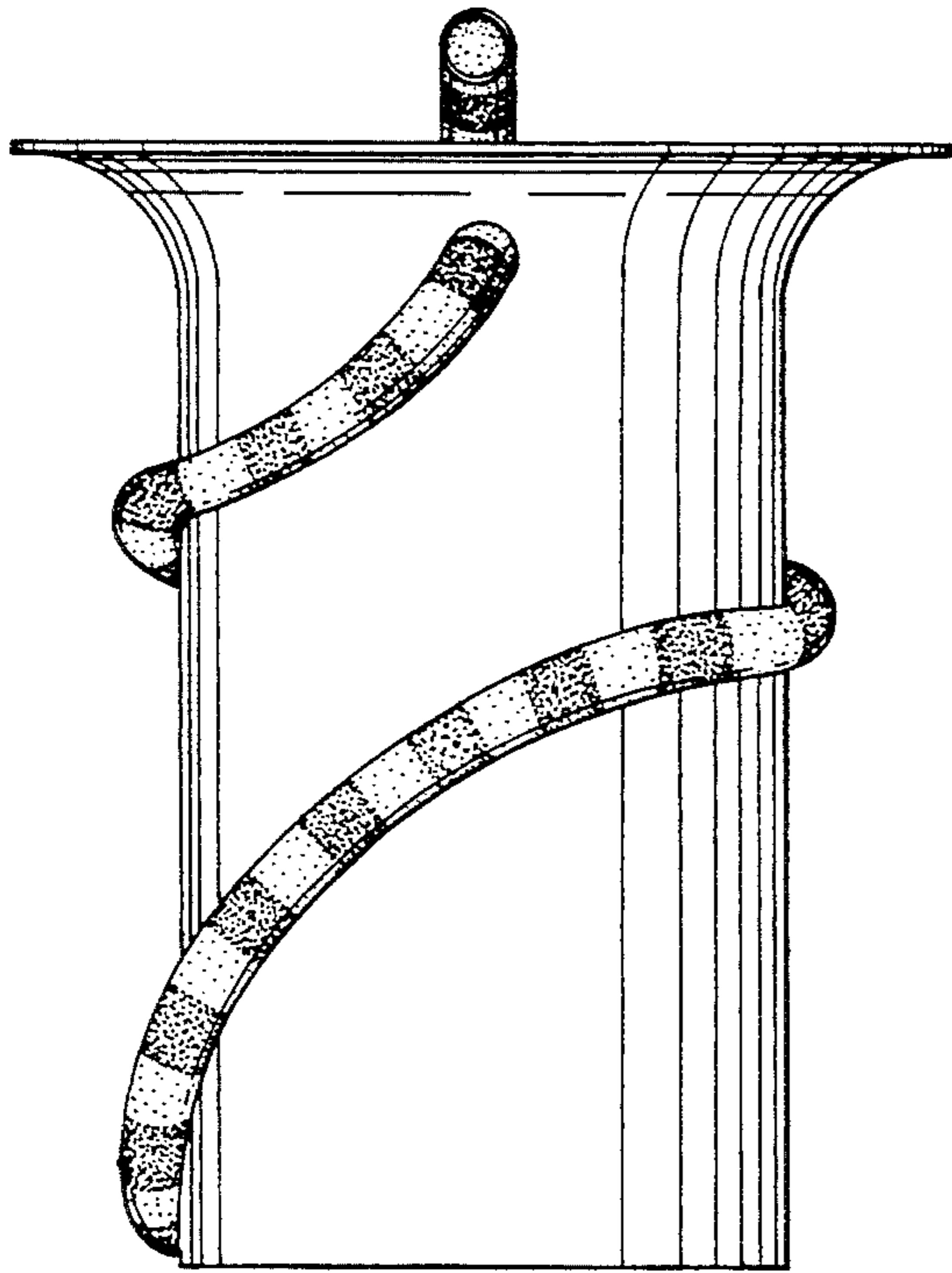

FIG. 1

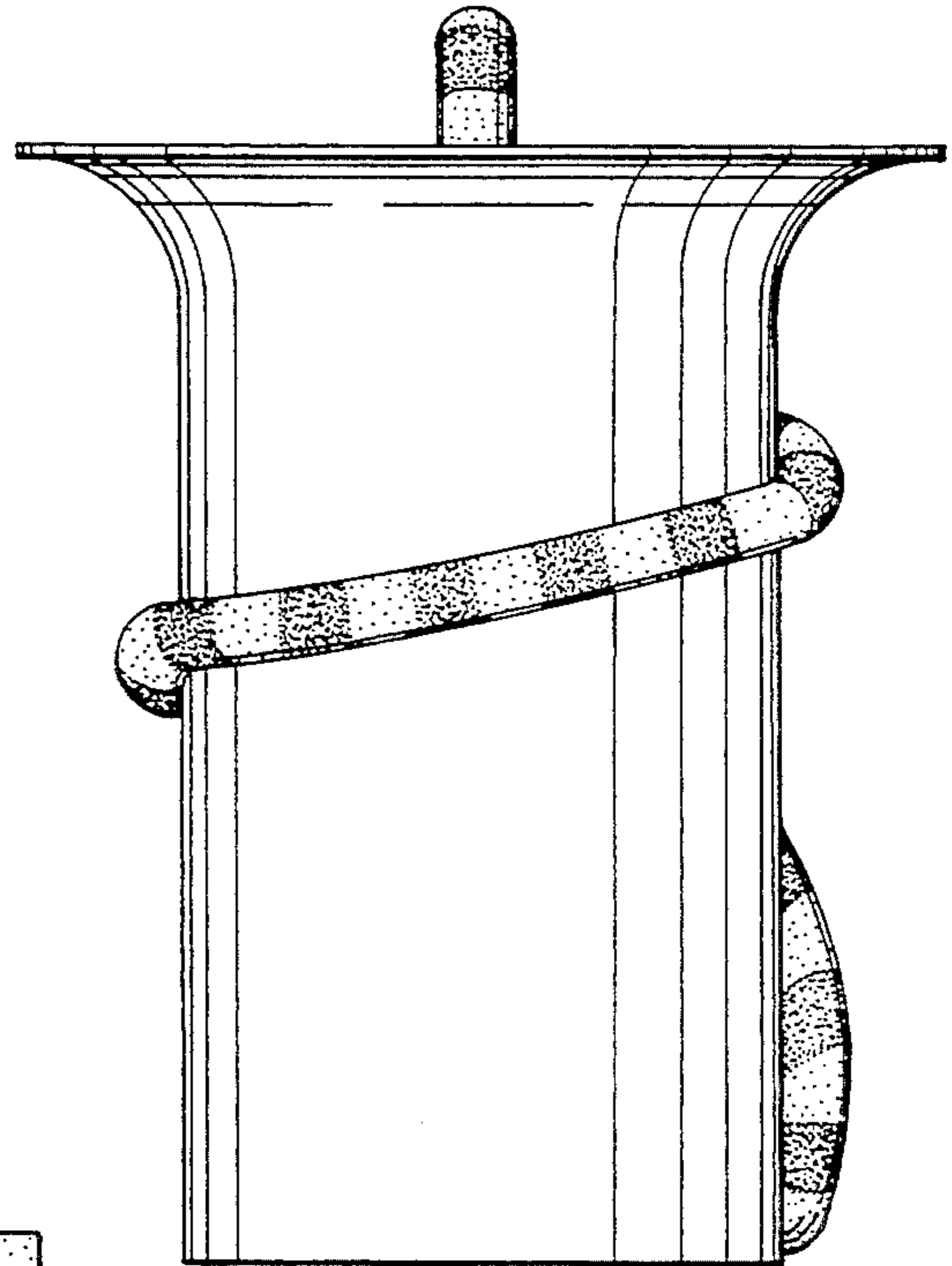

FIG. 2

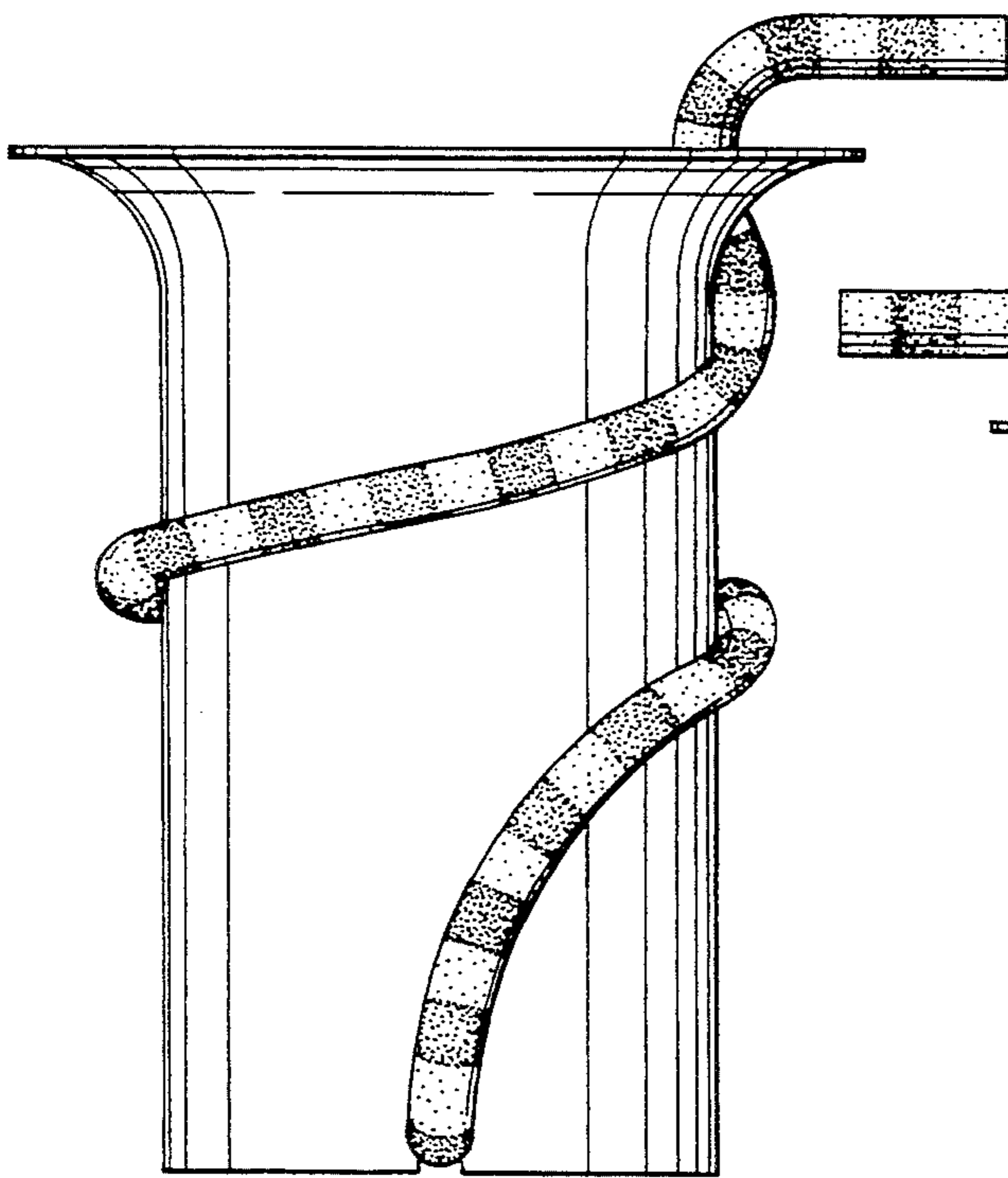

FIG. 3

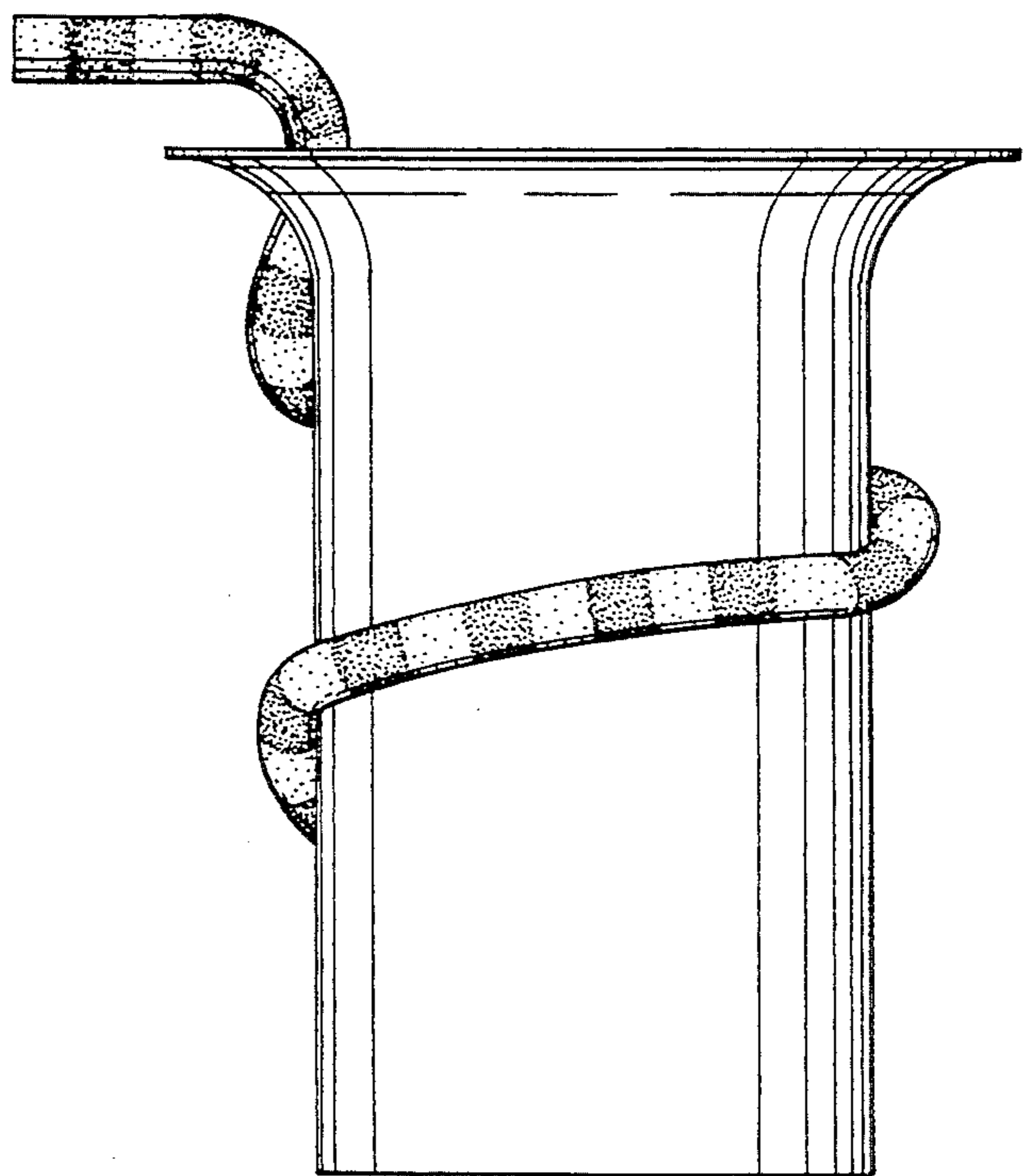

FIG. 4

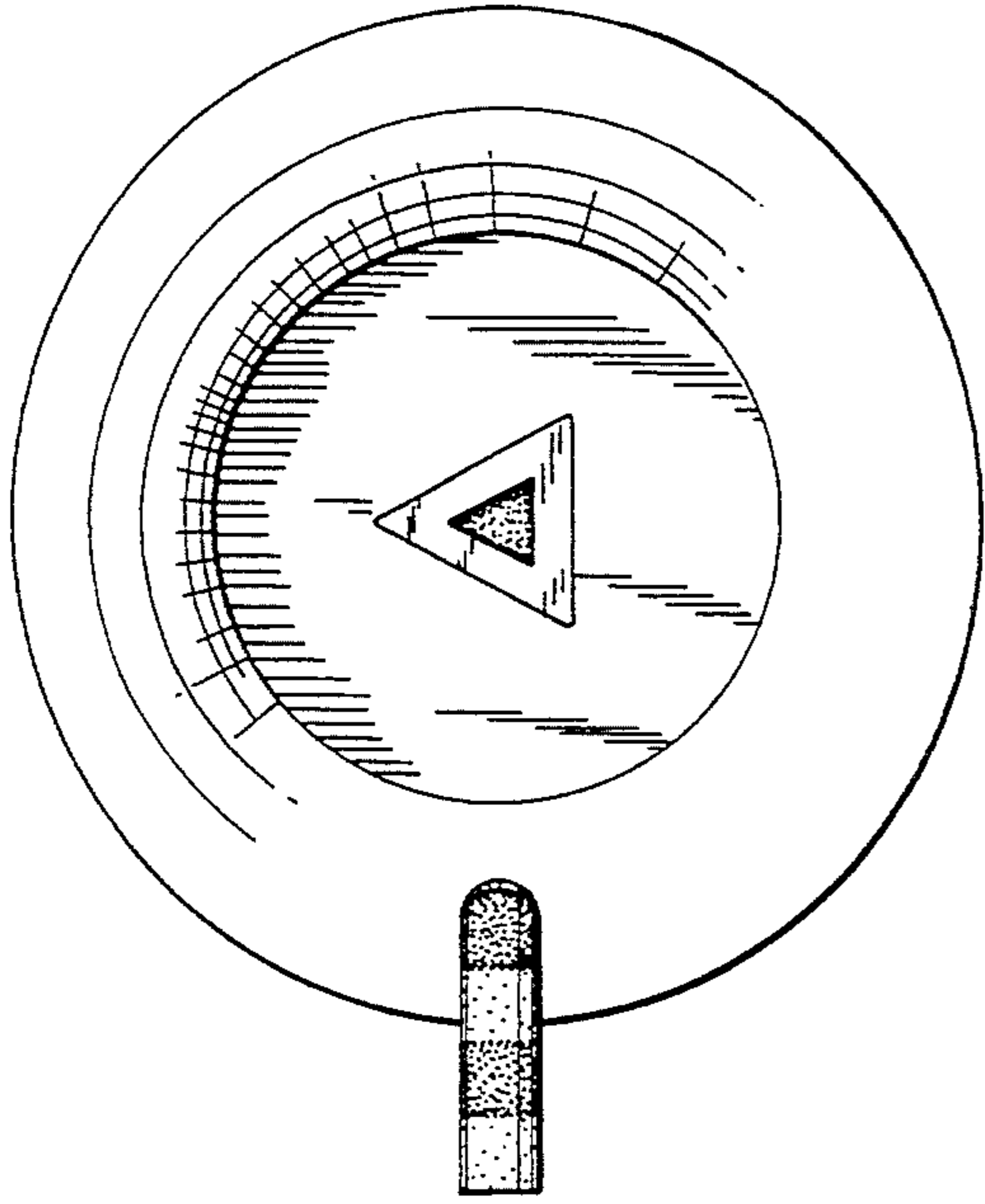

FIG. 5

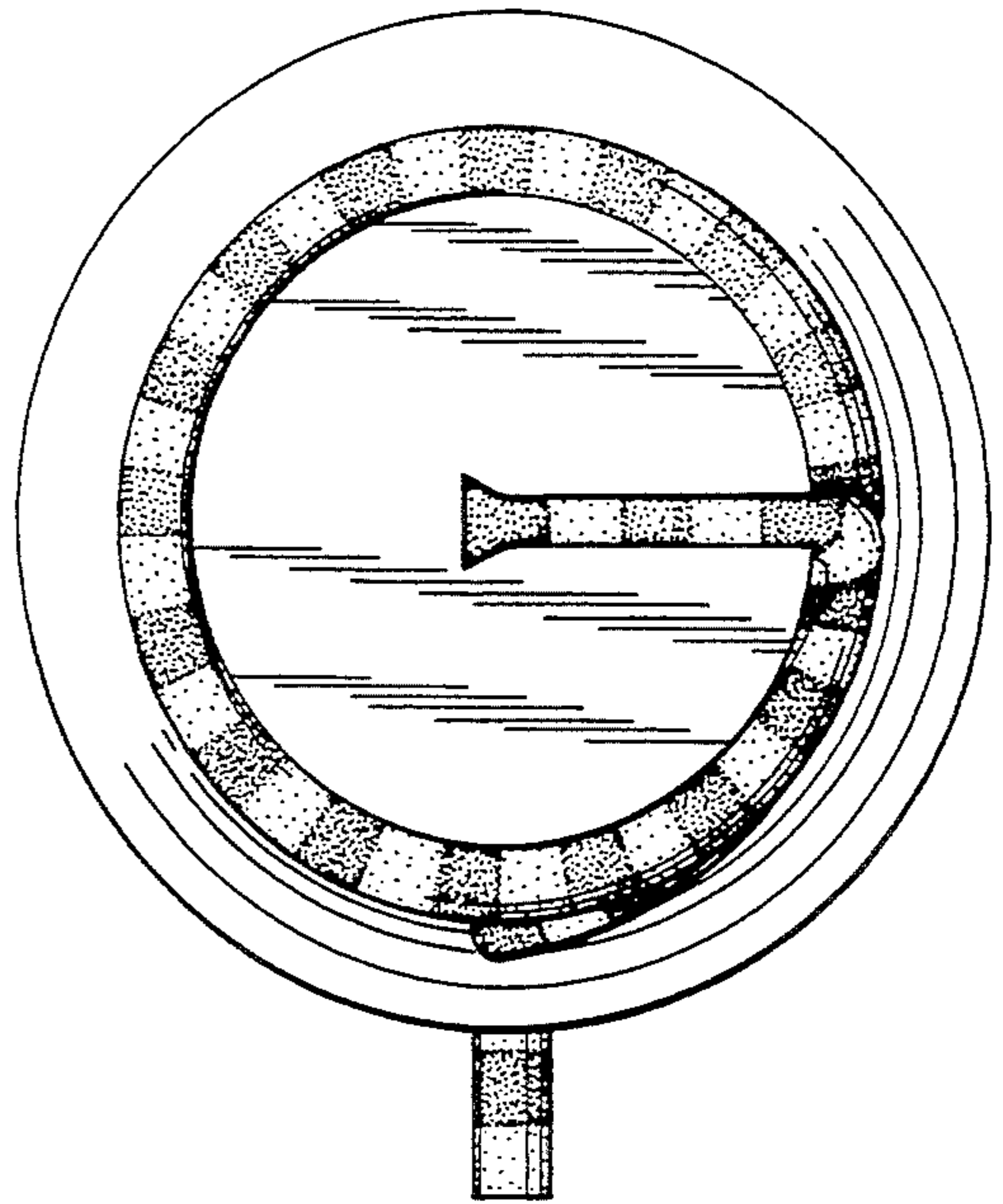

FIG. 6

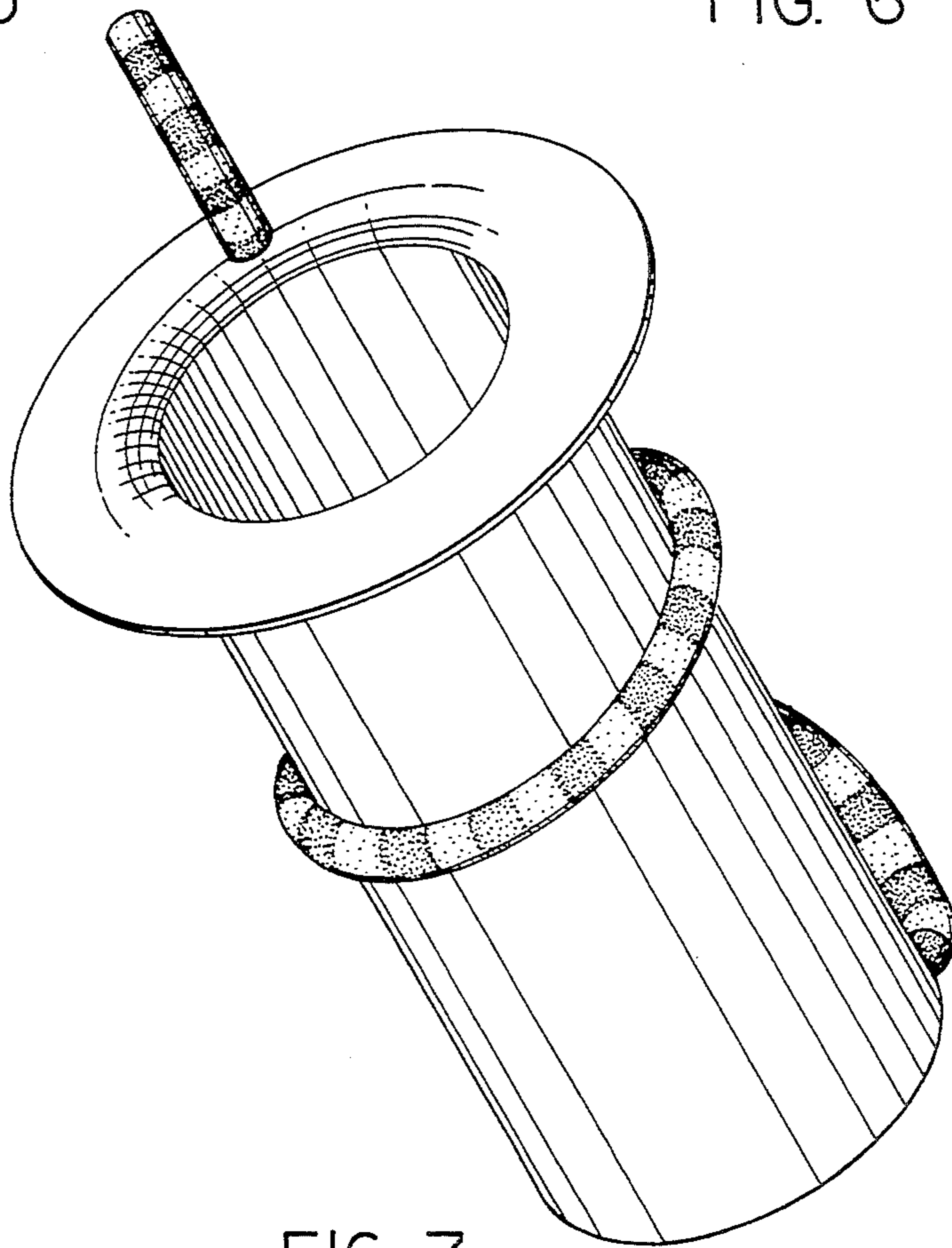

FIG. 7