



US00D360488S

United States Patent [19]
Cardinal

[11] **Patent Number: Des. 360,488**

[45] **Date of Patent: ** Jul. 18, 1995**

[54] **FACE GUARD WITH TRANSPARENT VISOR**

[75] **Inventor: Gilles Cardinal, St. Luc, Canada**

[73] **Assignee: Itech Sport Products, Inc.,
Dollard-des-Ormeaux, Canada**

[**] **Term: 14 Years**

[21] **Appl. No.: 23,476**

[22] **Filed: May 25, 1994**

[52] **U.S. Cl. D29/111**

[58] **Field of Search D29/108-111,
D29/122; 2/2, 424, 425, 9, 10, 418, 422, 15**

[56] **References Cited**

U.S. PATENT DOCUMENTS

- D. 280,460 9/1985 Eronberg et al. D29/111
- D. 282,117 1/1986 Gronberg et al. D29/111

- D. 349,978 8/1994 Copeland et al. D29/111
- D. 351,929 10/1994 Chiasson D29/110
- 4,933,933 6/1990 McClelland 2/9
- 5,129,108 7/1992 Copeland et al. 2/424
- 5,249,347 10/1993 Martinitz 2/9

Primary Examiner—Ruth McInroy

[57] **CLAIM**

The ornamental design for a face guard with transparent visor, as shown and described.

DESCRIPTION

FIG. 1 is a perspective view of a face guard with a transparent visor showing my new design; FIG. 2 is a front elevational view thereof; FIG. 3 is a rear elevational view thereof; FIG. 4 is a side elevational view thereof; FIG. 5 is a top plan view thereof; and, FIG. 6 is a bottom plan view thereof.

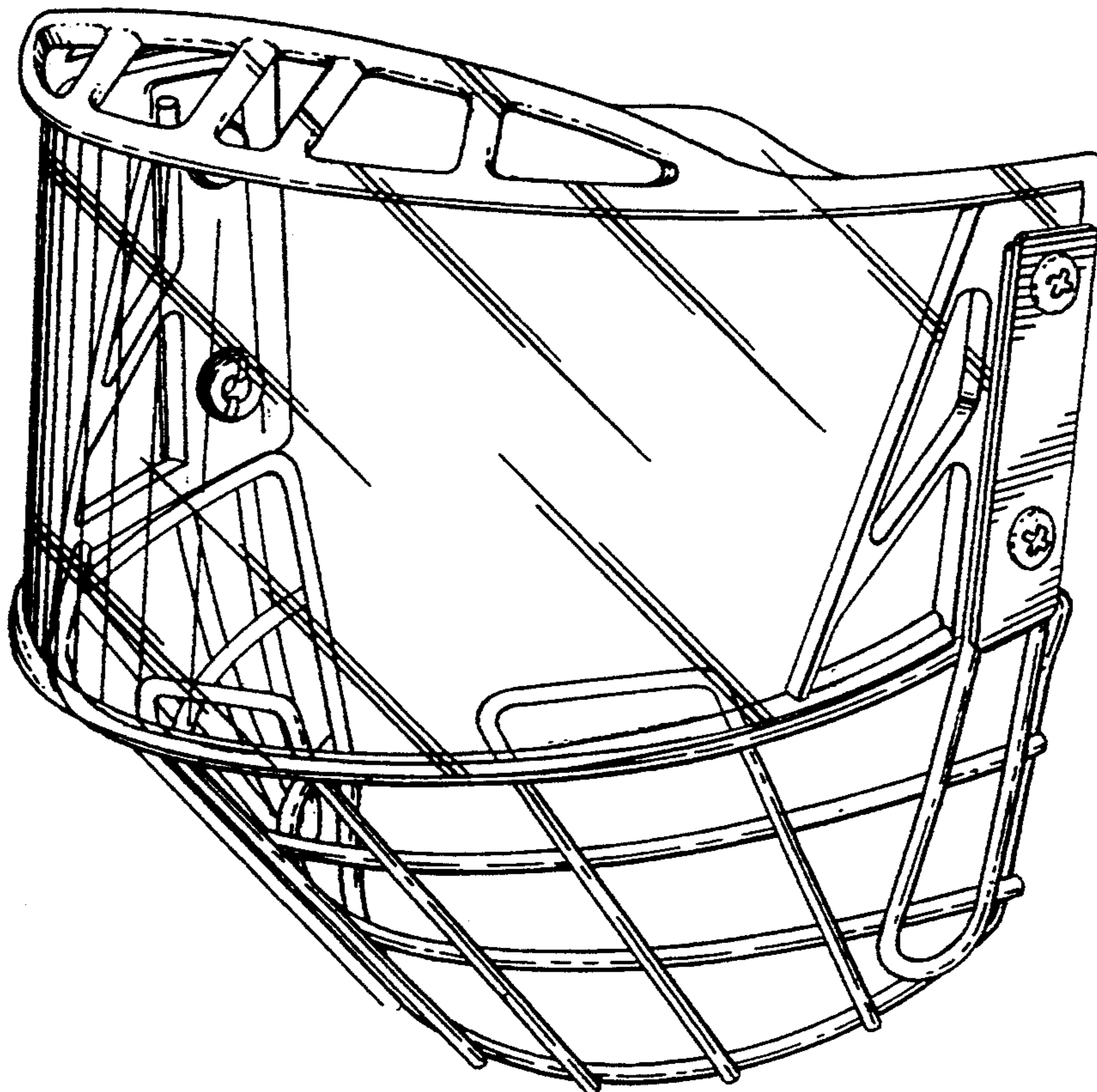

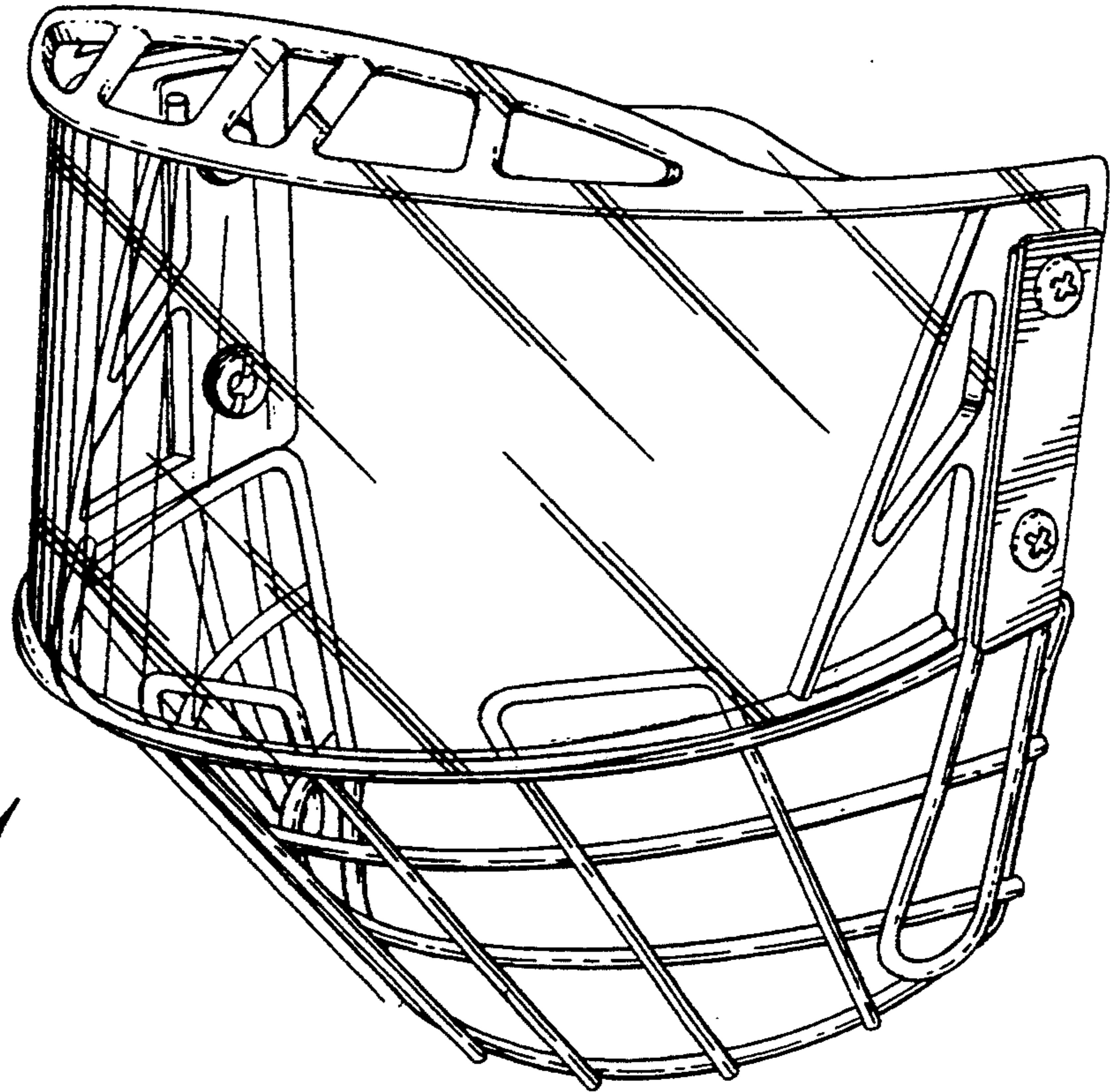

Fig. 1

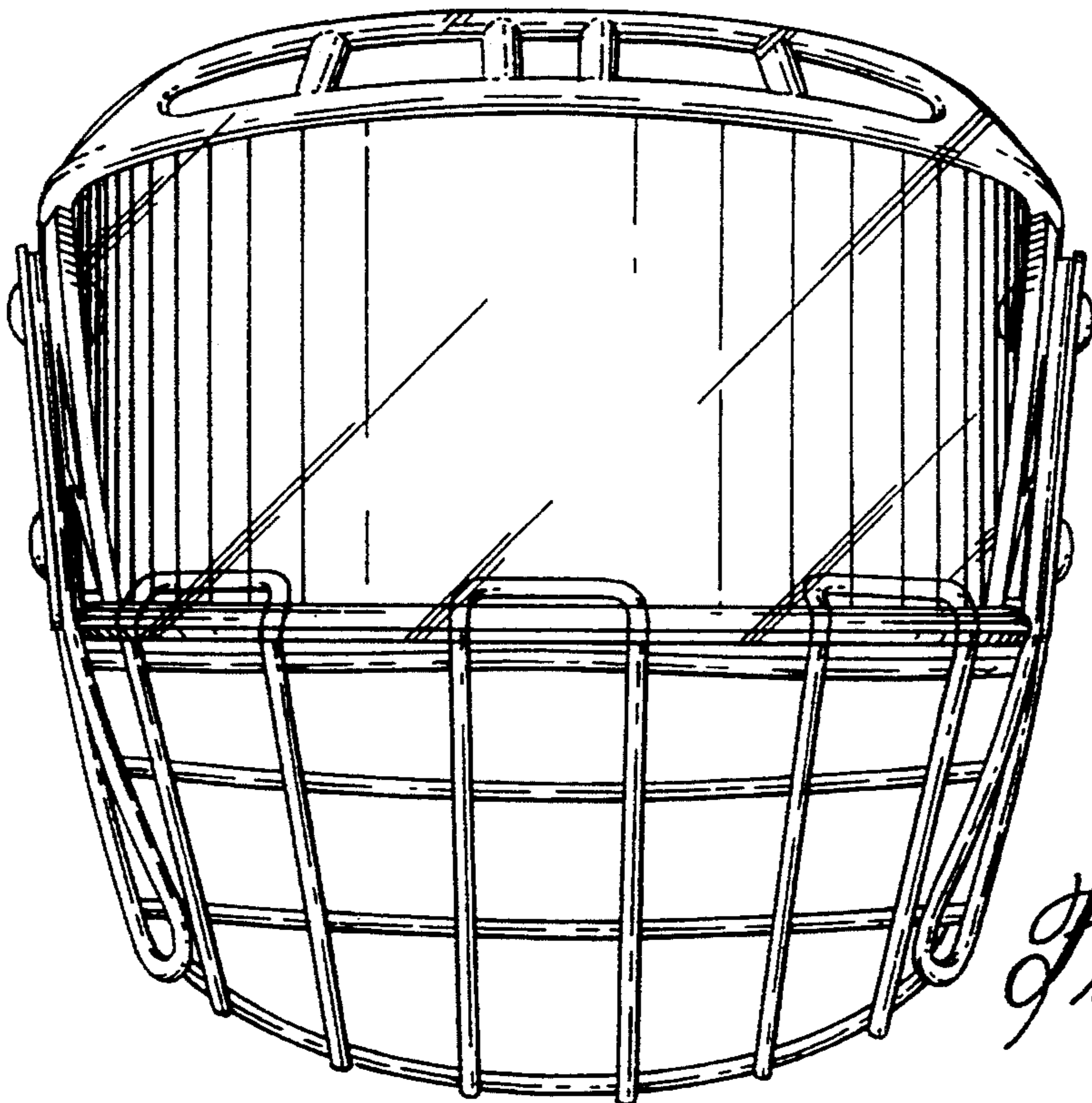

Fig. 2

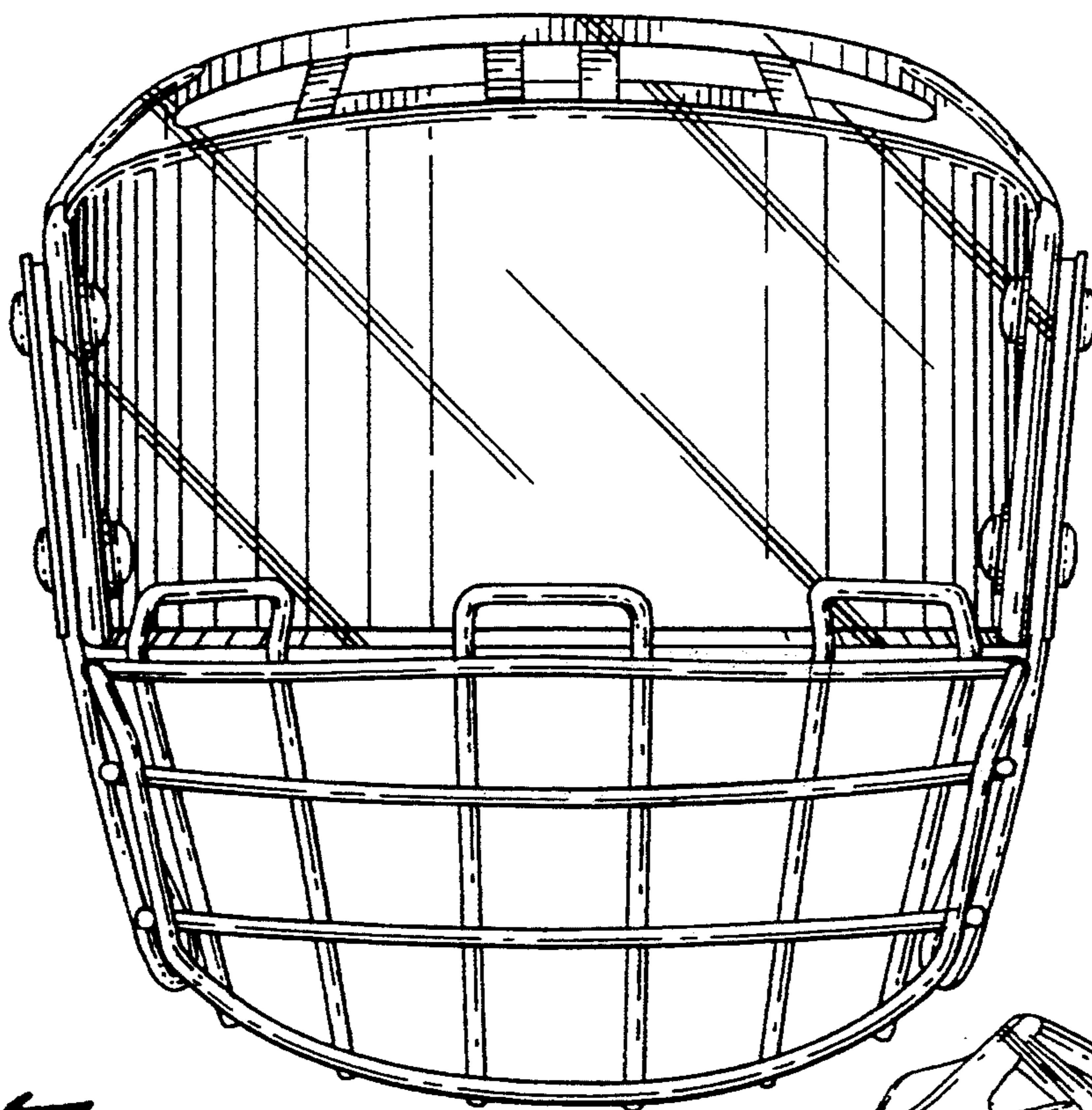

Fig. 3

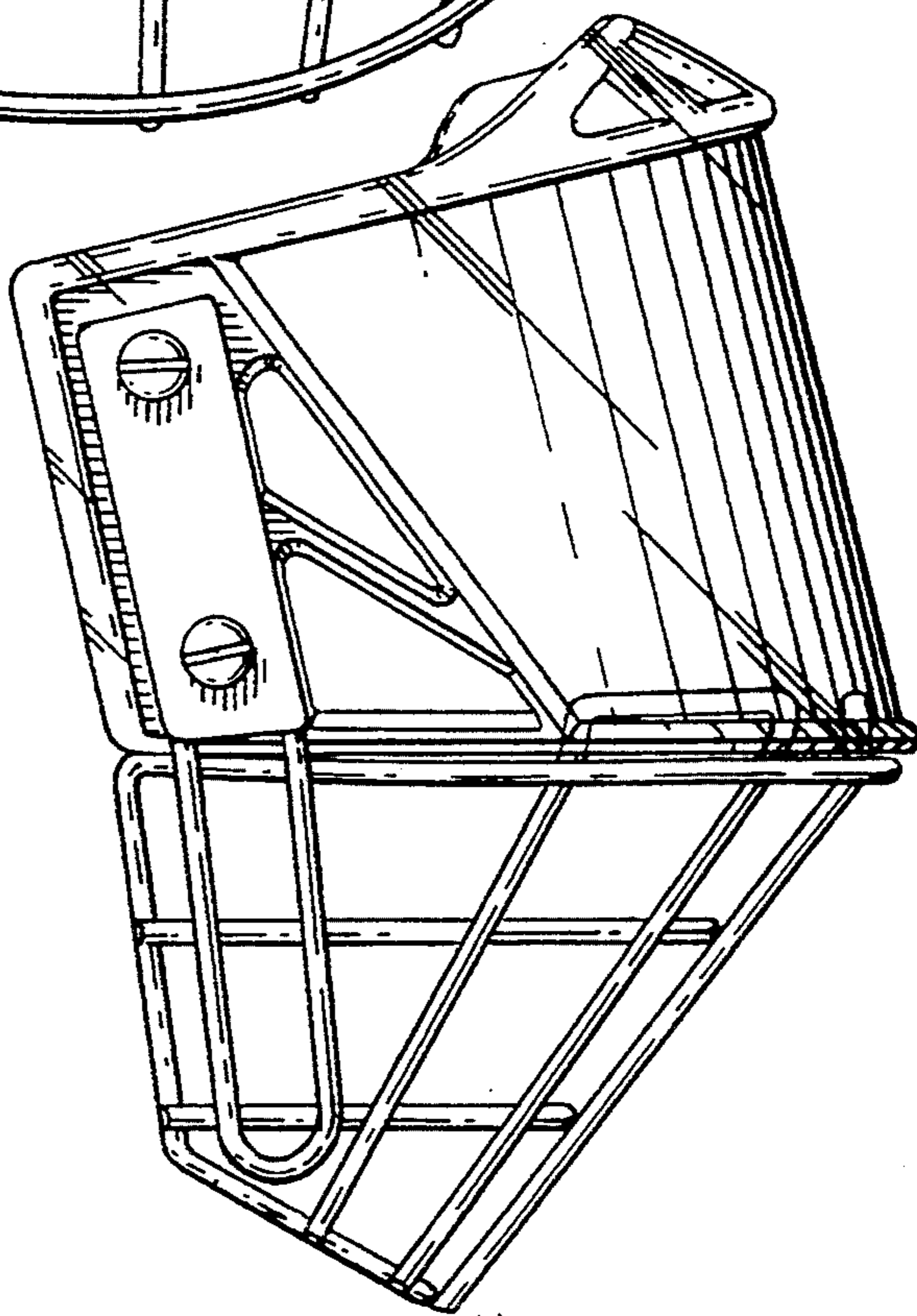

Fig. 4

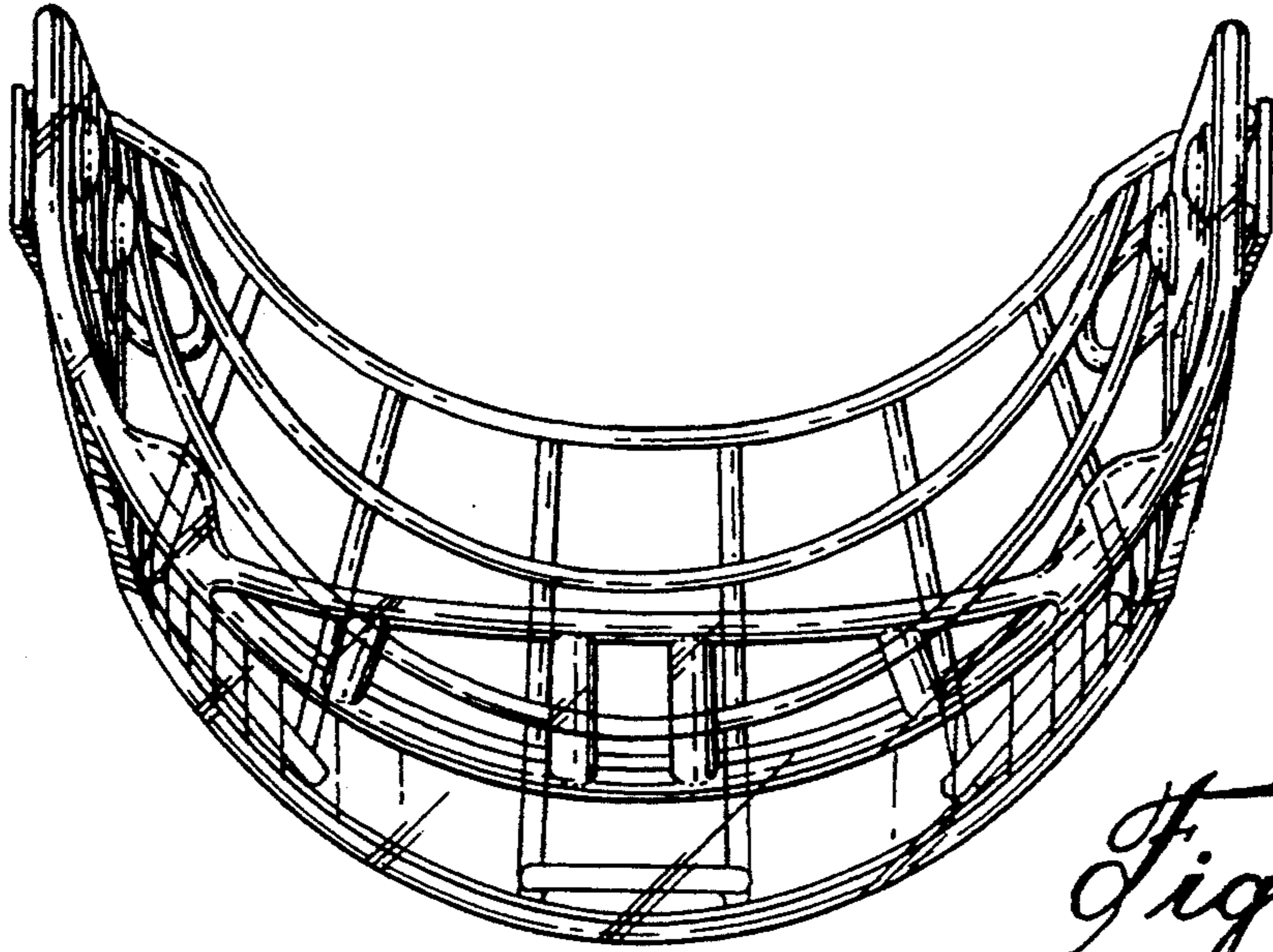

Fig. 5

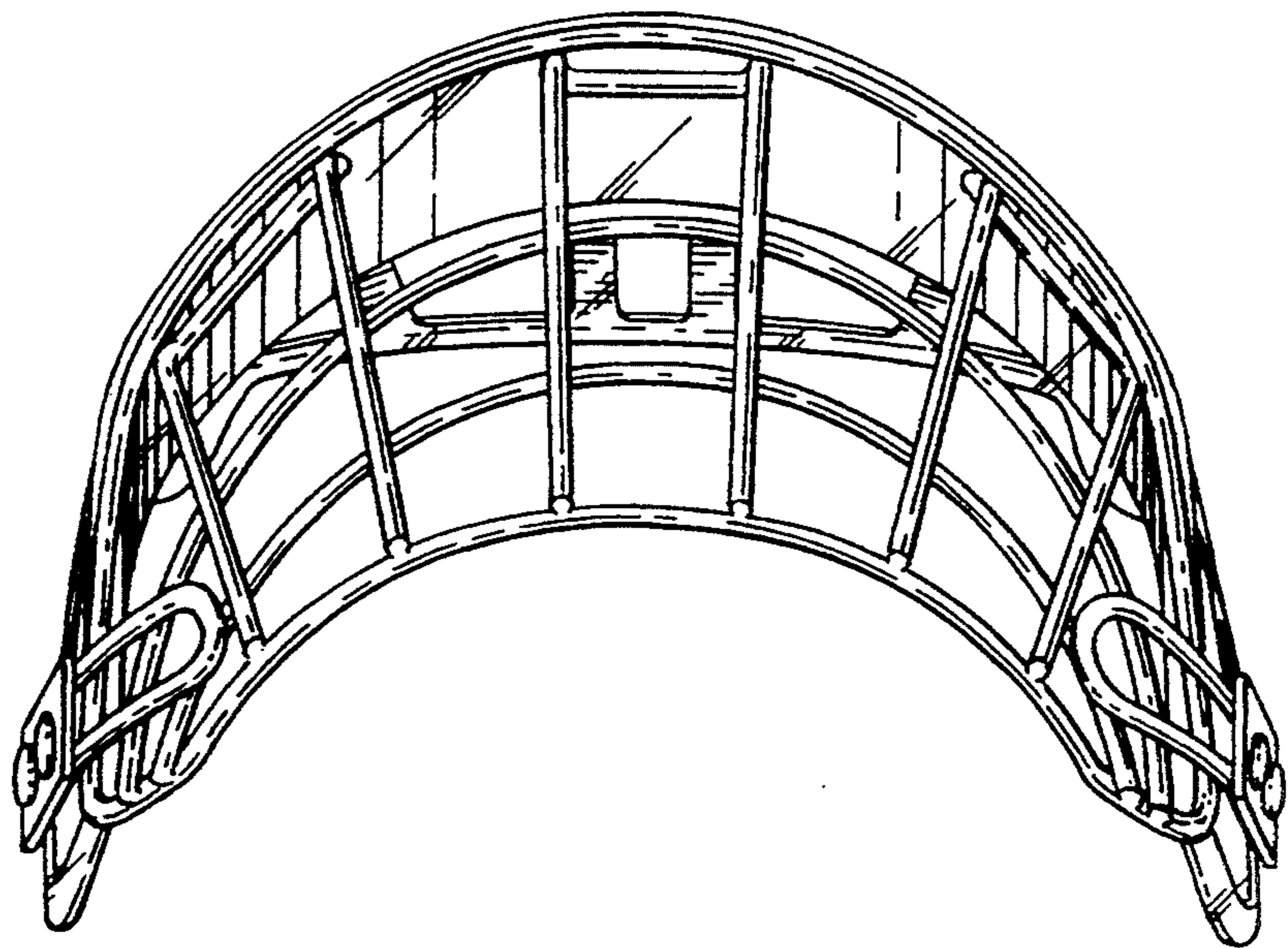

Fig. 6