



US00D360353S

United States Patent [19]

Schriever

[11] Patent Number: Des. 360,353

[45] Date of Patent: ** Jul. 18, 1995

[54] TIE DOWN EYELET
[76] Inventor: Frederick G. Schriever, 64 Clairview Rd., Grosse Pointe Shores, Mich. 48236

[**] Term: 14 Years

[21] Appl. No.: 14,917

[22] Filed: Nov. 3, 1993

[52] U.S. Cl. D8/356

[58] Field of Search D8/356, 367; 114/218; 248/56

4,191,108 3/1980 Jones 296/43 X
4,319,537 3/1982 Hackney 114/112
4,607,991 8/1986 Porter 296/43 X
4,812,093 3/1989 Millar, Jr. 410/110

OTHER PUBLICATIONS

Wilcox-Crittendon, Dec. 12, 1987, p. 26, bow eye, circled at top left of page.

Primary Examiner—A. Hugo Word
Assistant Examiner—Holly H. Baynham
Attorney, Agent, or Firm—Brooks & Kushman

[56] References Cited

U.S. PATENT DOCUMENTS

D. 172,741 8/1954 Cooper .
D. 193,579 9/1962 Frisch D8/356
D. 241,117 8/1976 Holtz D8/367
D. 272,987 3/1984 Allen D8/354
D. 275,868 10/1984 Ake D8/367
D. 298,645 11/1988 Miyata et al. D8/356 X
D. 309,251 7/1990 Palmer D8/367
3,421,726 1/1969 Getter 410/110
3,595,125 7/1971 Jacobs 296/43 X
3,866,873 2/1975 Bohli D8/354
3,871,637 3/1975 Mueller et al. 248/499

[57] CLAIM

The ornamental design for a tie down eyelet, as shown and described.

DESCRIPTION

FIG. 1 is a sectional view taken along the line 1—1 of FIG. 3;
FIG. 2 is a top plan view thereof;
FIG. 3 is a front elevational view thereof with the opposite side being a mirror image thereof;
FIG. 4 is a side elevational view thereof with the opposite side being a mirror image thereof;
FIG. 5 is a bottom plan view thereof; and,
FIG. 6 is a perspective view thereof.

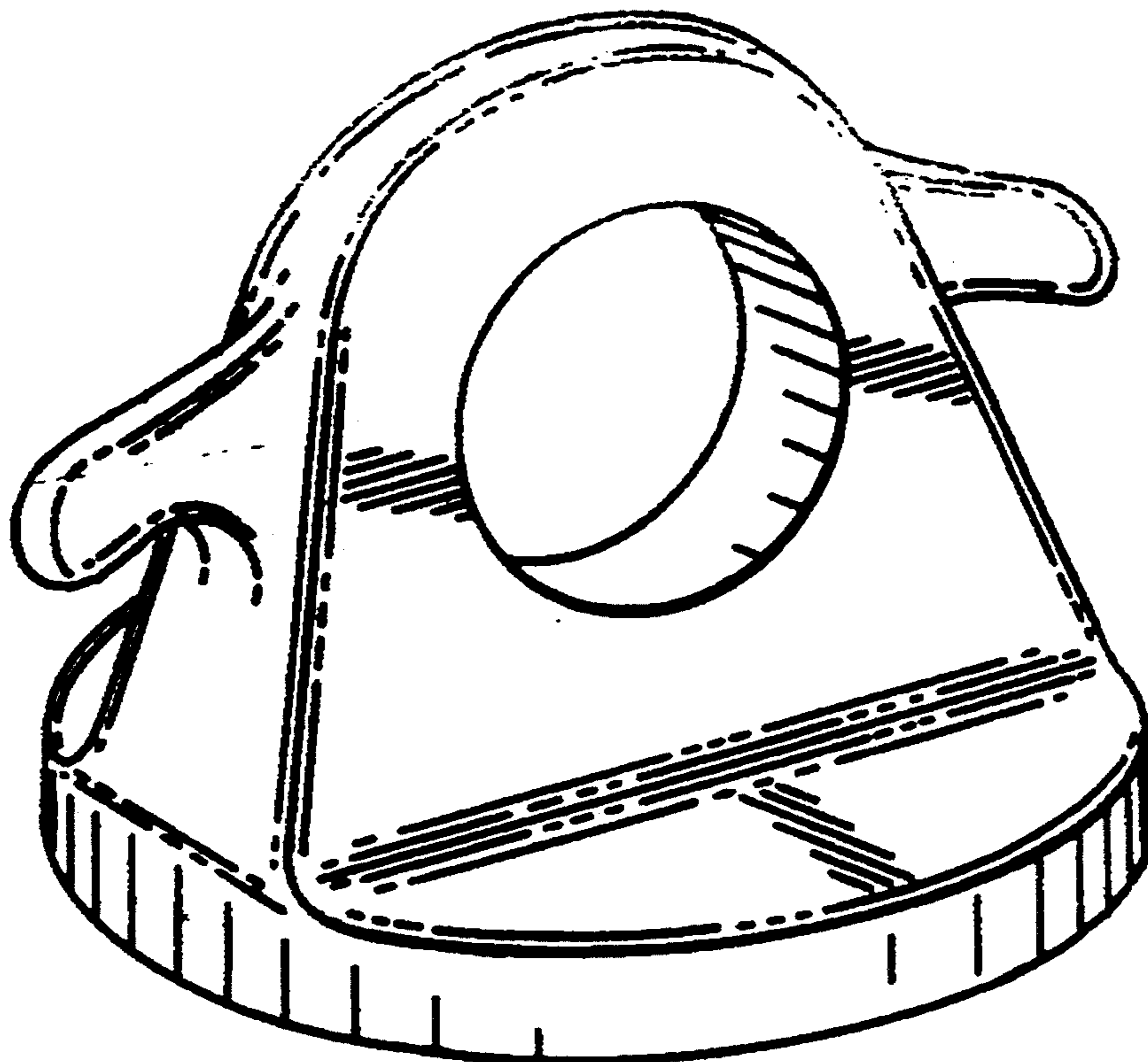

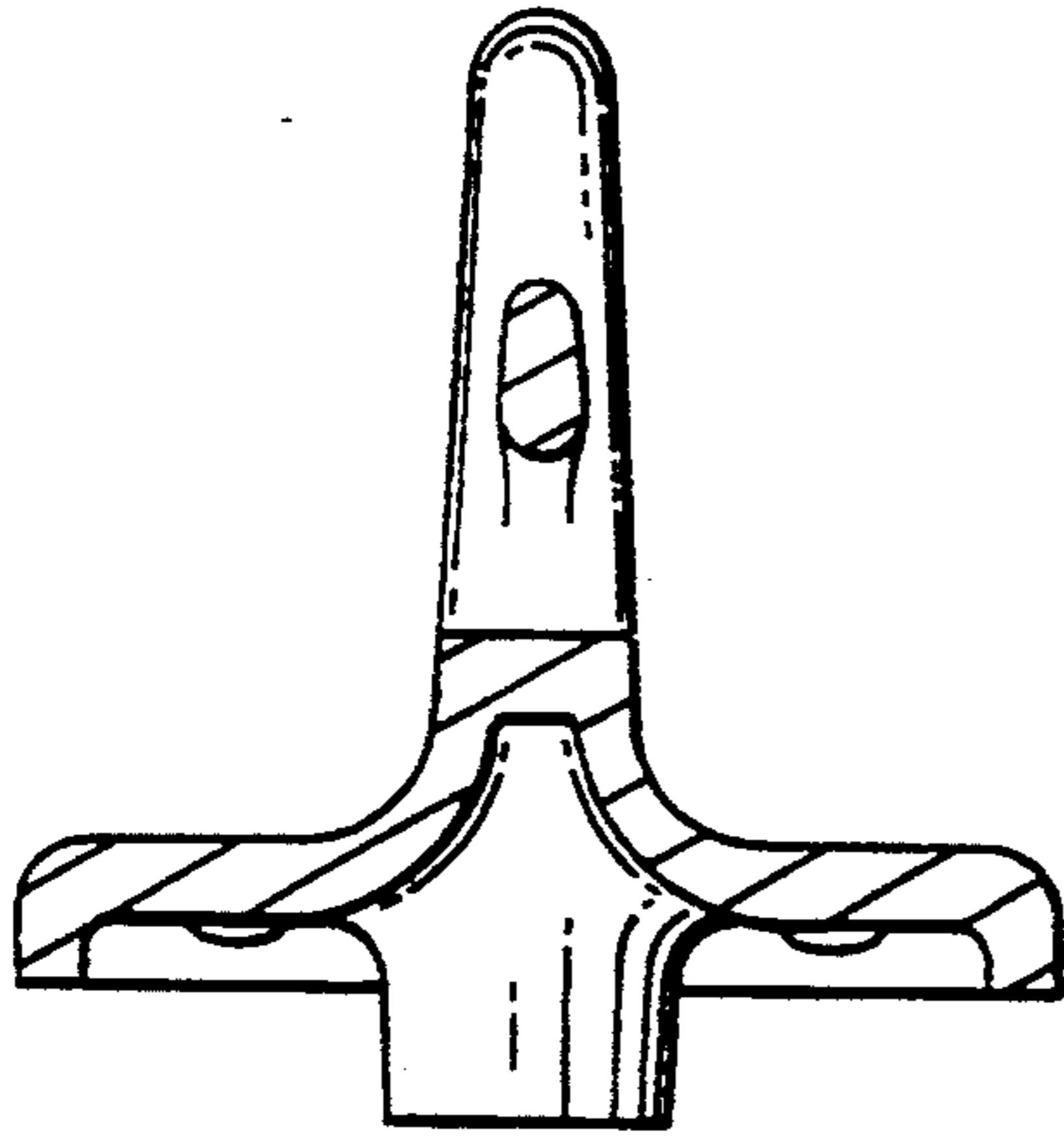

FIG. 1

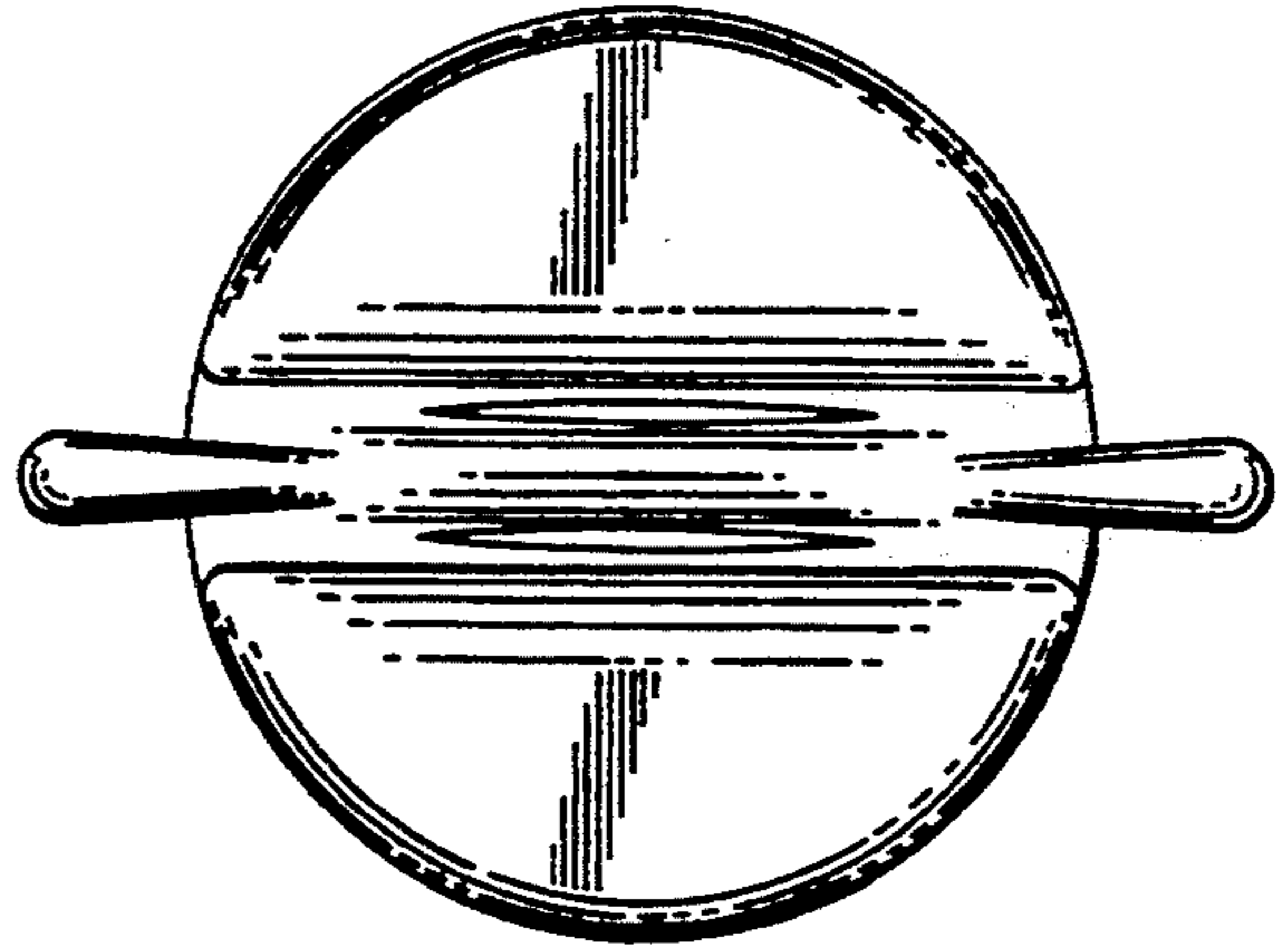

FIG. 2

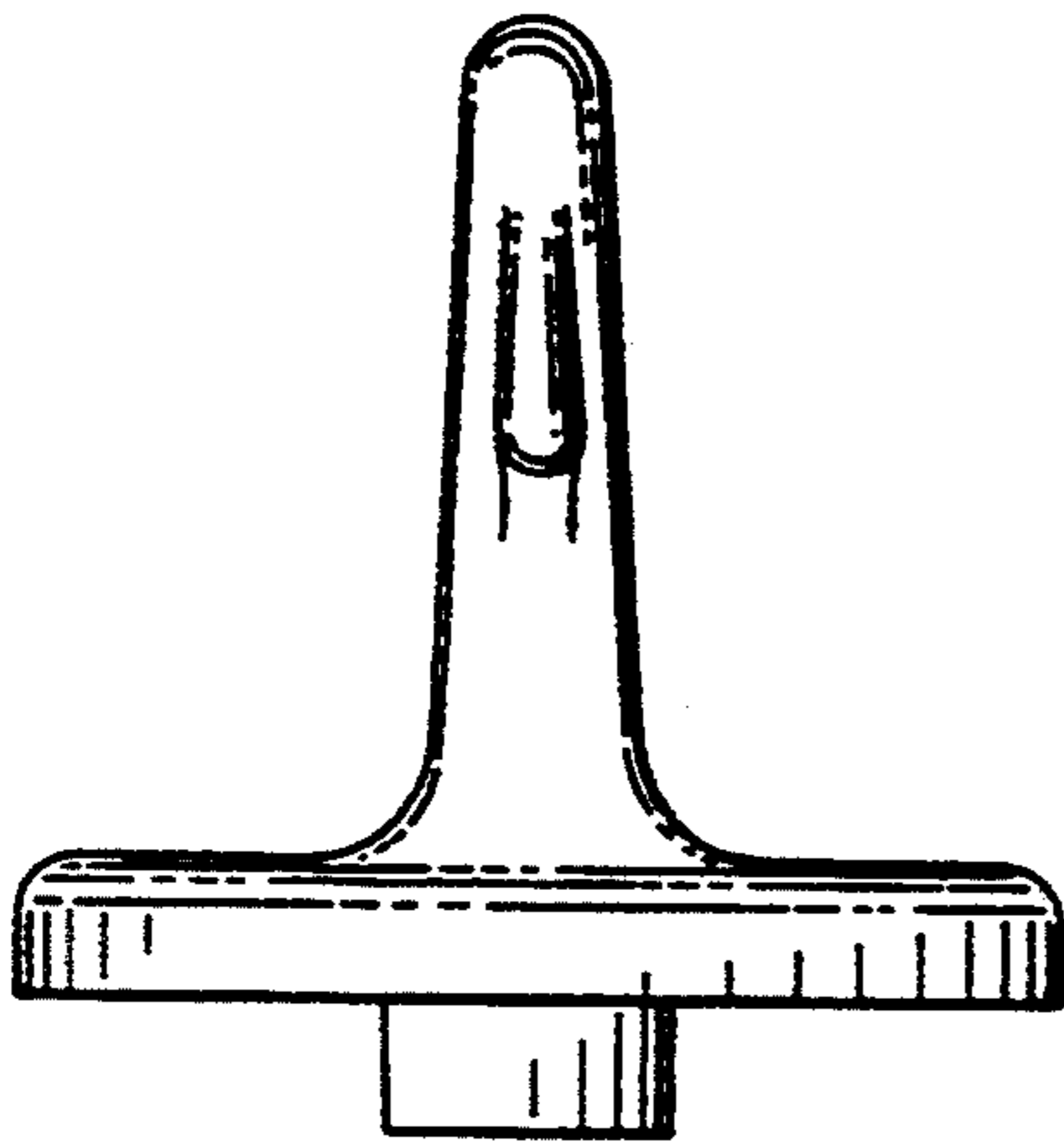

FIG. 4

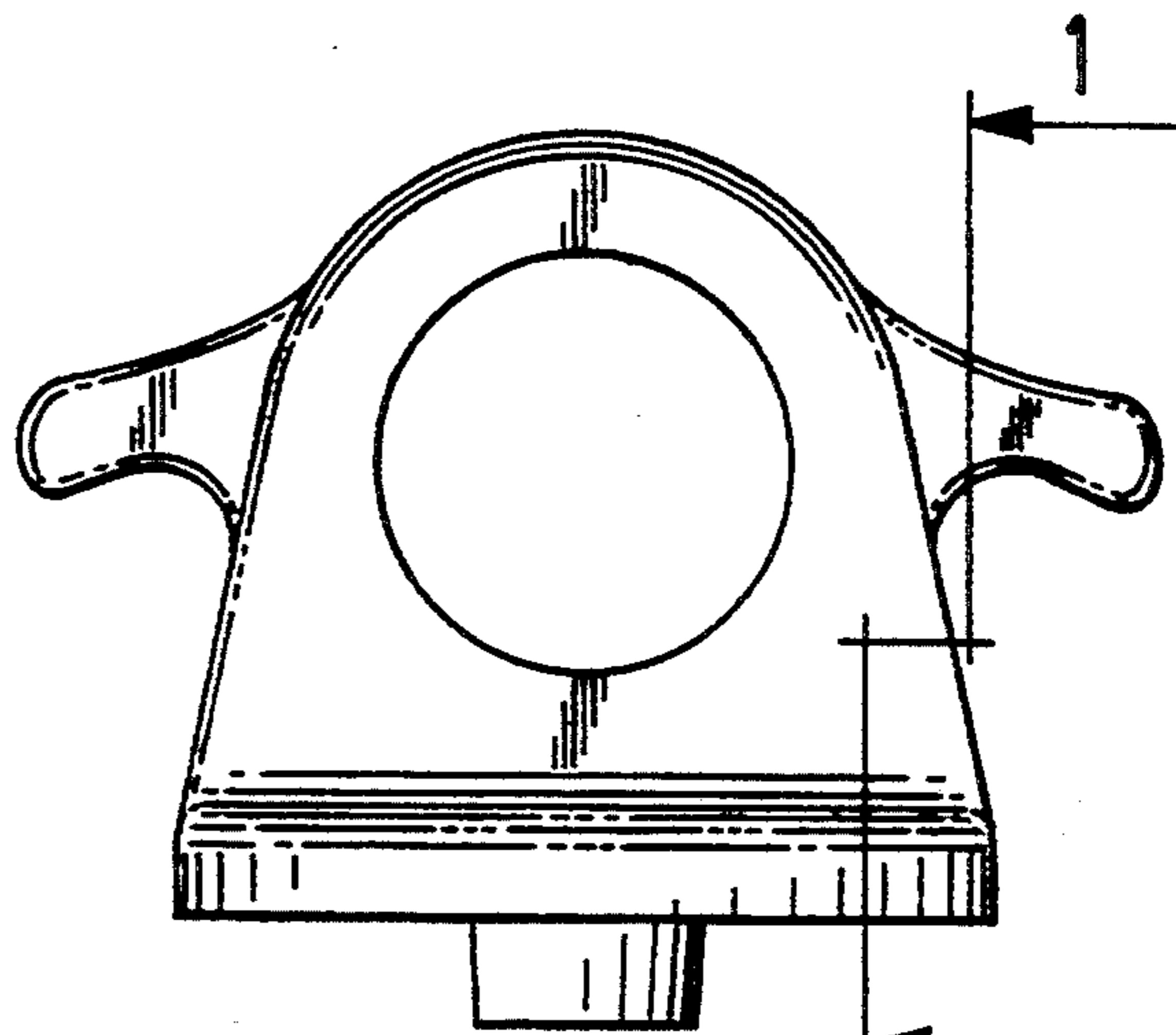

FIG. 3

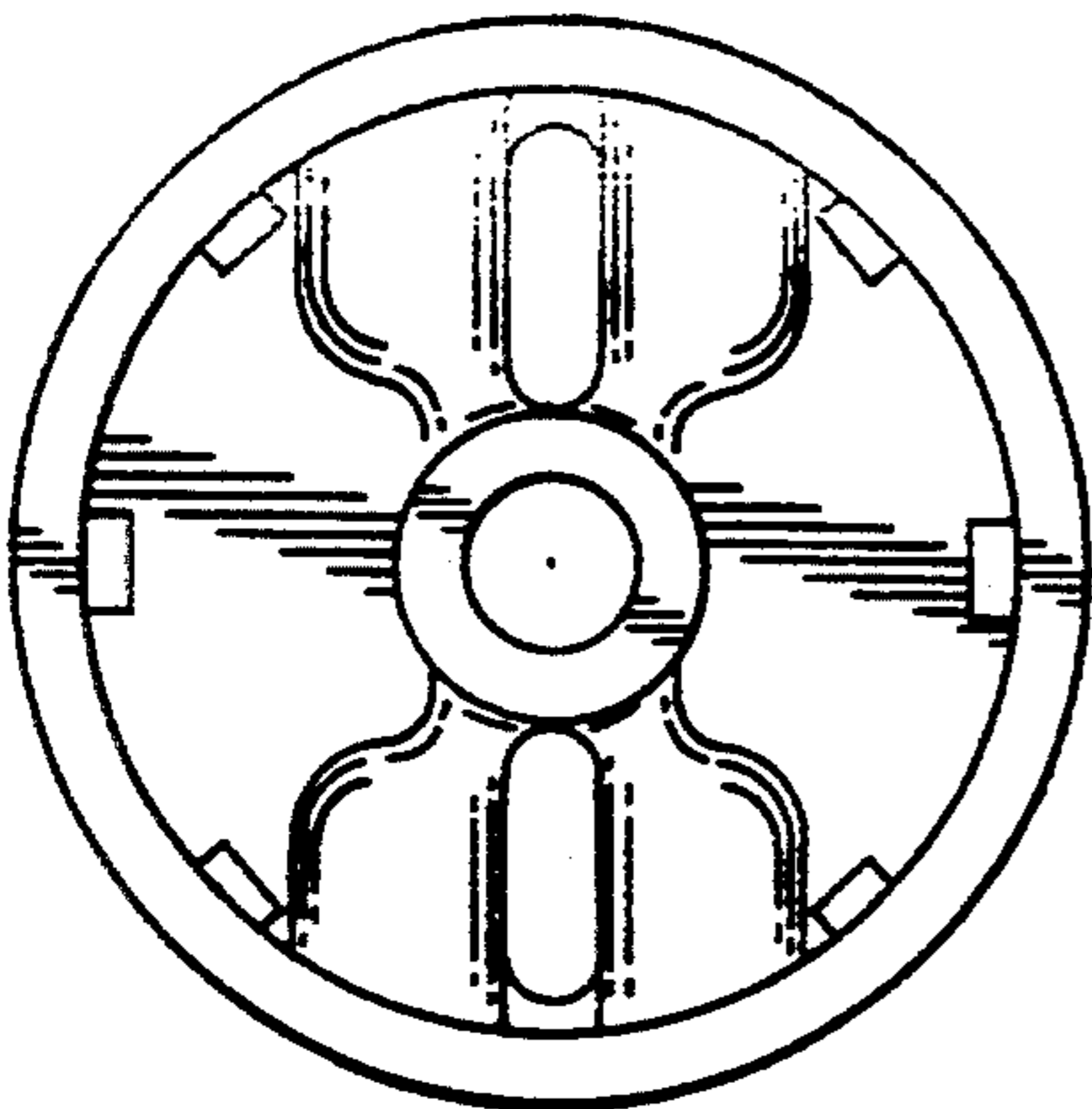

FIG. 5

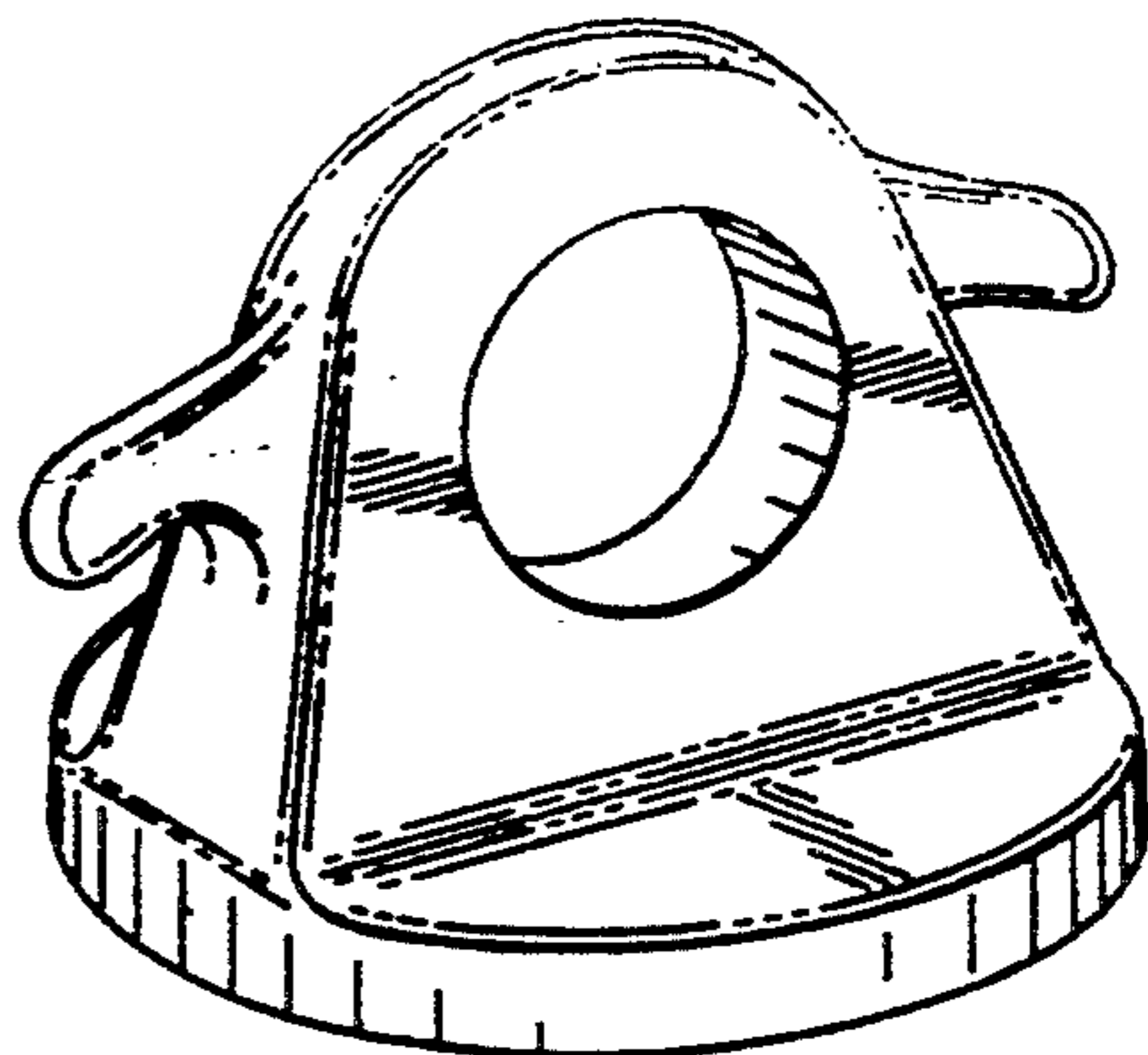

FIG. 6