



US00D360337S

United States Patent [19]

[11] Patent Number: Des. 360,337

Ward, Jr.

[45] Date of Patent: ** Jul. 18, 1995

[54] CUP WITH POMPON AND POMPON COVER

[76] Inventor: Alexander H. Ward, Jr., 5604 Winner Ave., Baltimore, Md. 21215

[*] Notice: The portion of the term of this patent subsequent to Nov. 15, 2008 has been disclaimed.

[**] Term: 14 Years

[21] Appl. No.: 29,070

[22] Filed: Sep. 28, 1994

[52] U.S. Cl. D7/507; D7/515

[58] Field of Search D7/507, 506, 509, 514, D7/515, 523, 511; D9/307, 319, 337, 503, 438; 428/4

2,962,201	11/1960	Brillis et al.	D7/523 X
4,055,840	10/1977	Uchytel	340/321
4,125,218	11/1978	DeBoer	D7/507 X
4,369,215	1/1983	Offen et al.	428/4
4,527,719	7/1985	Mackrill	223/44
4,786,535	11/1988	Young	428/4
4,806,396	2/1989	Pratt et al.	428/4
4,809,353	2/1989	Cheng	383/6
4,881,485	11/1989	Feinberg	116/28

Primary Examiner—Alan P. Douglas
Assistant Examiner—M. N. Pandozzi
Attorney, Agent, or Firm—Cornell D. M. Judge Cornish

[57] CLAIM

The ornamental design for cup with pompon and pompon cover, as shown as described.

DESCRIPTION

FIG. 1 is an exploded top perspective view of a cup with pompon and pompon cover showing my new design;
FIG. 2 is a bottom plan view thereof;
FIG. 3 is a side elevational view thereof with the pompon in its stored position;
FIG. 4 is a partial side elevational view broken away for ease of illustration;
FIG. 5 is a partial rear elevational view thereof, where the upper portion is broken away for case of illustration; and,
FIG. 6 is a top plan view thereof.

[56] References Cited

U.S. PATENT DOCUMENTS

D. 170,099	7/1953	Taylor	D7/509
D. 202,568	10/1965	Pool	D7/523
D. 248,916	8/1978	Reynolds et al.	D7/523
D. 261,086	10/1981	Trombly	D7/509
D. 289,955	5/1987	Buist	D7/507
D. 351,314	10/1994	Sokolski et al.	D7/511 X
2,103,831	12/1937	Sidon	D7/523 X
2,540,565	2/1951	Barbieri	D7/523 X
2,745,586	5/1956	Thoma	D7/507 X
2,867,365	1/1959	Tourette	D7/507 X

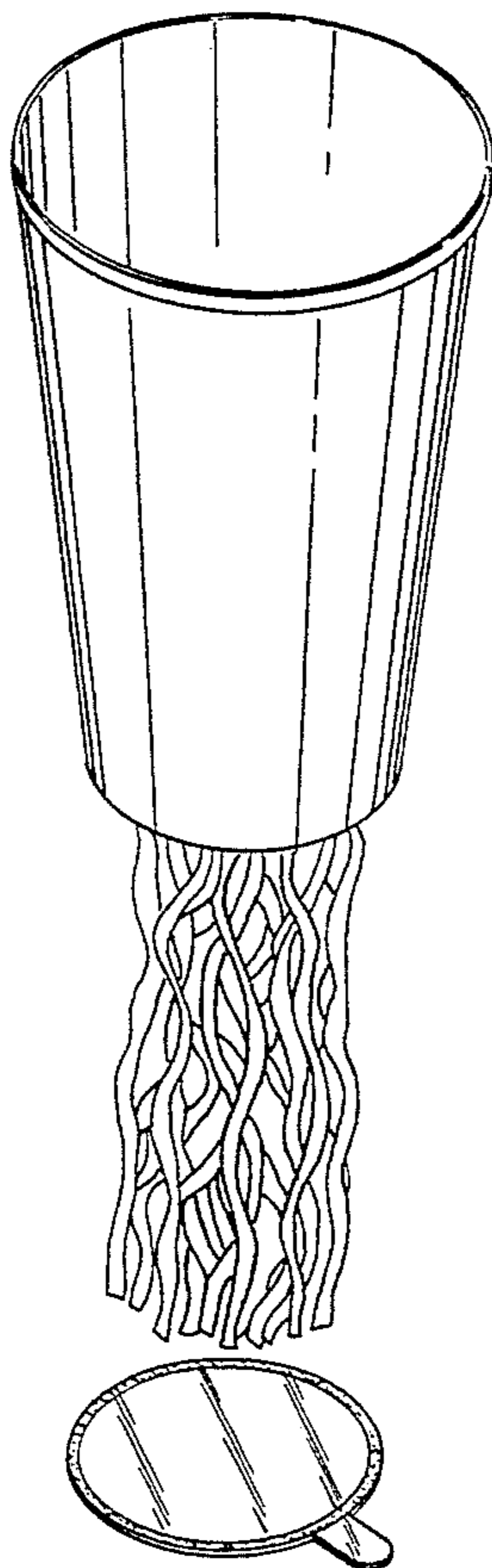

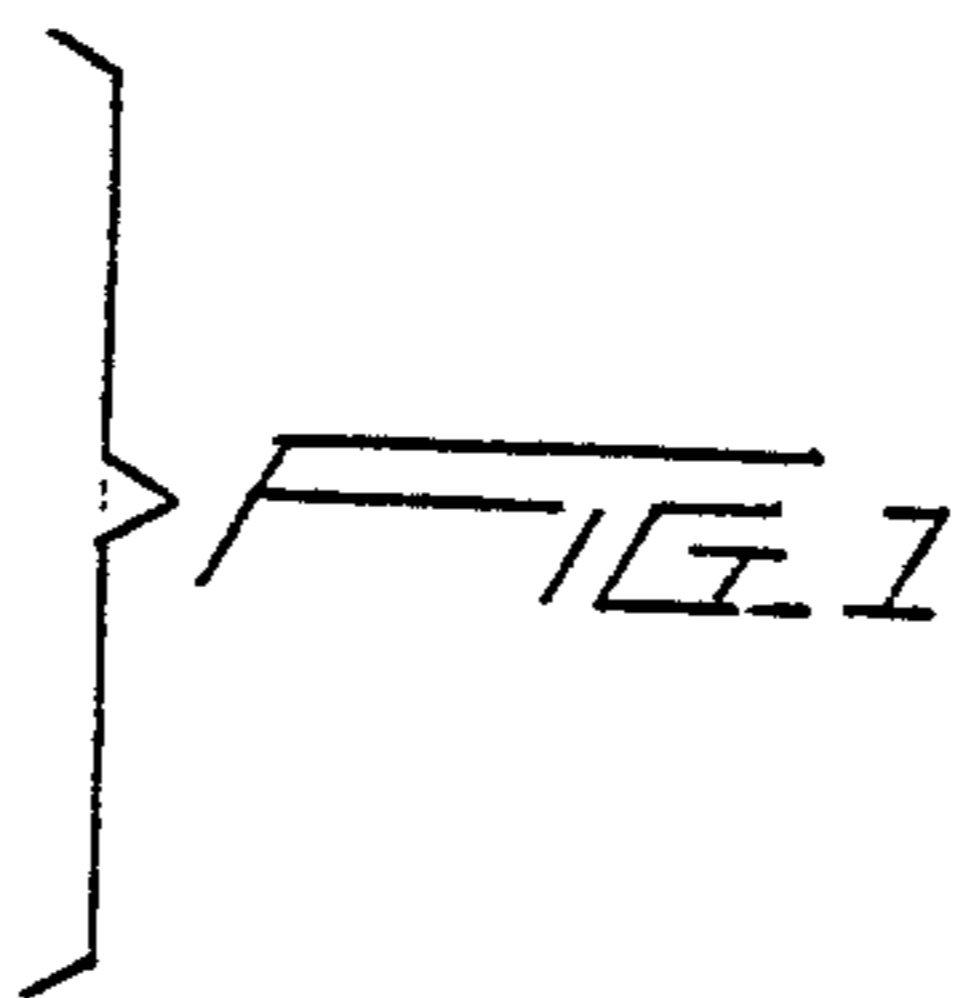
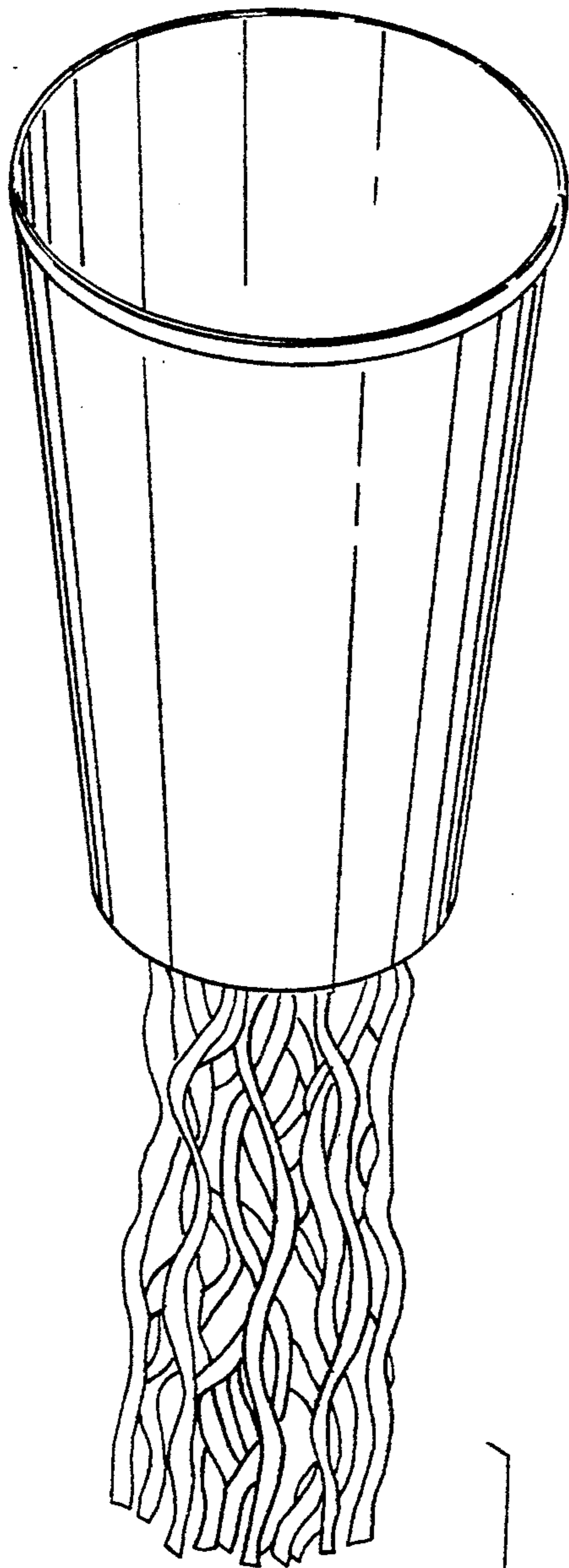

FIG. 2

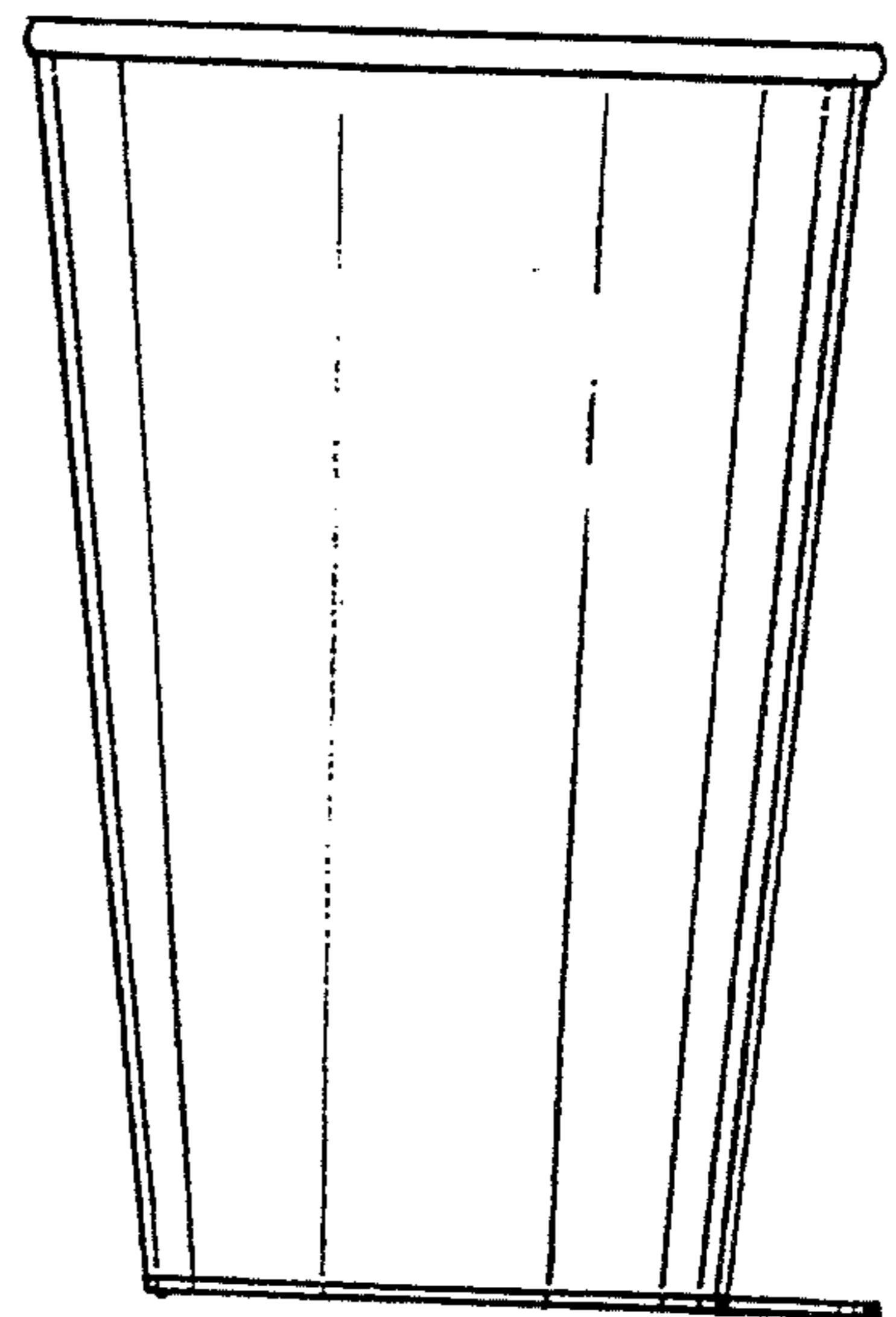
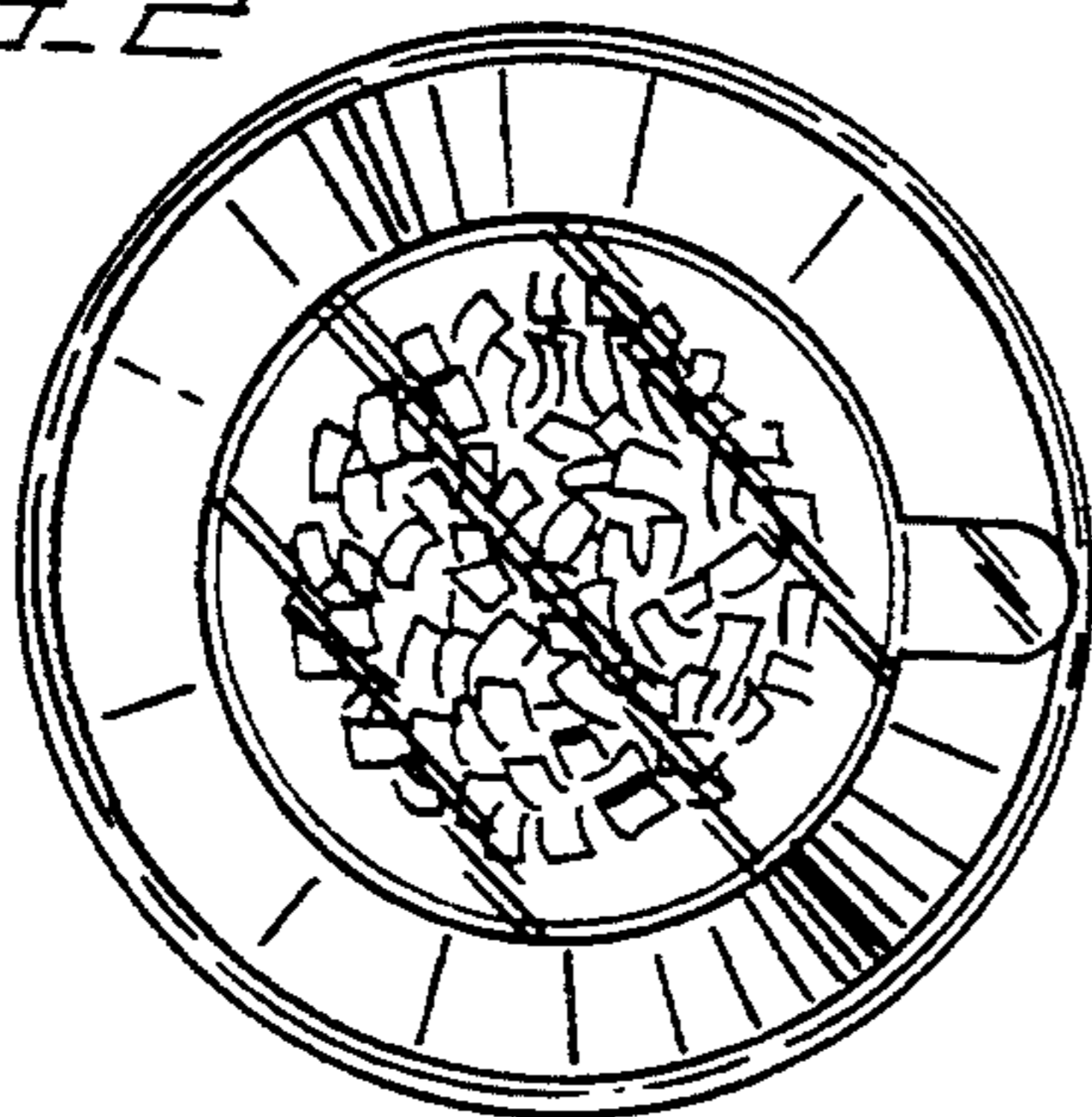

FIG. 3

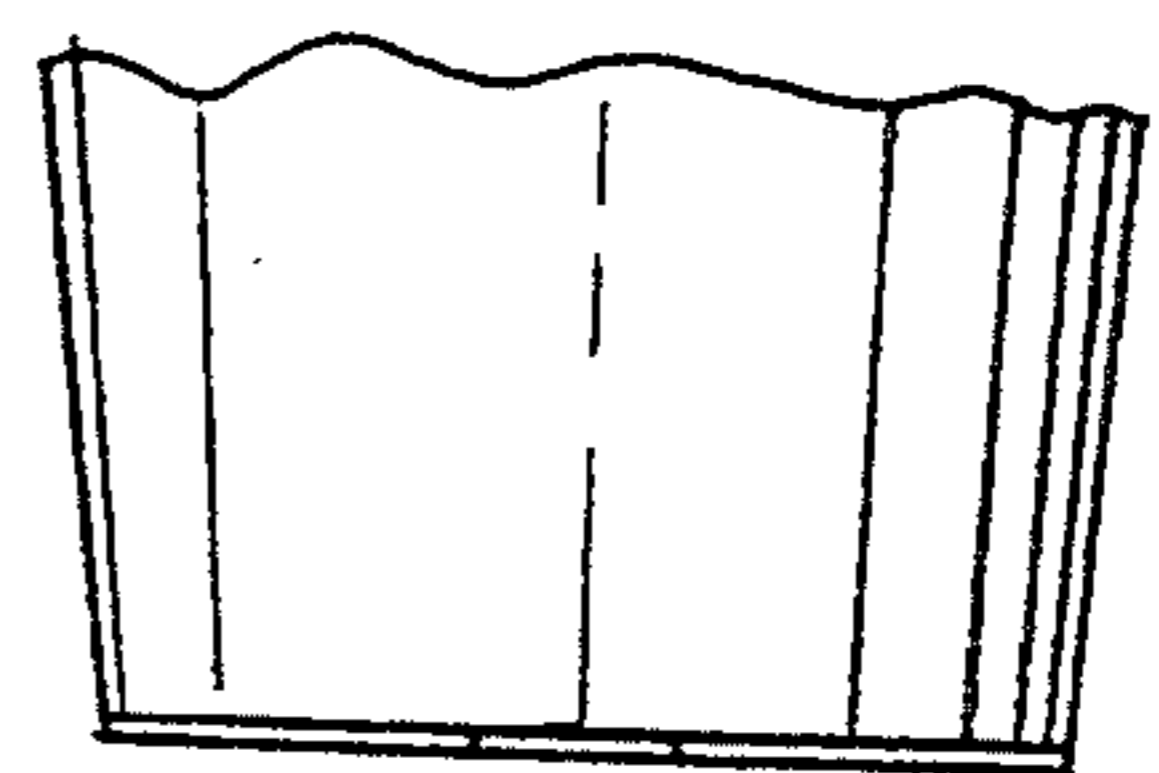

FIG. 4

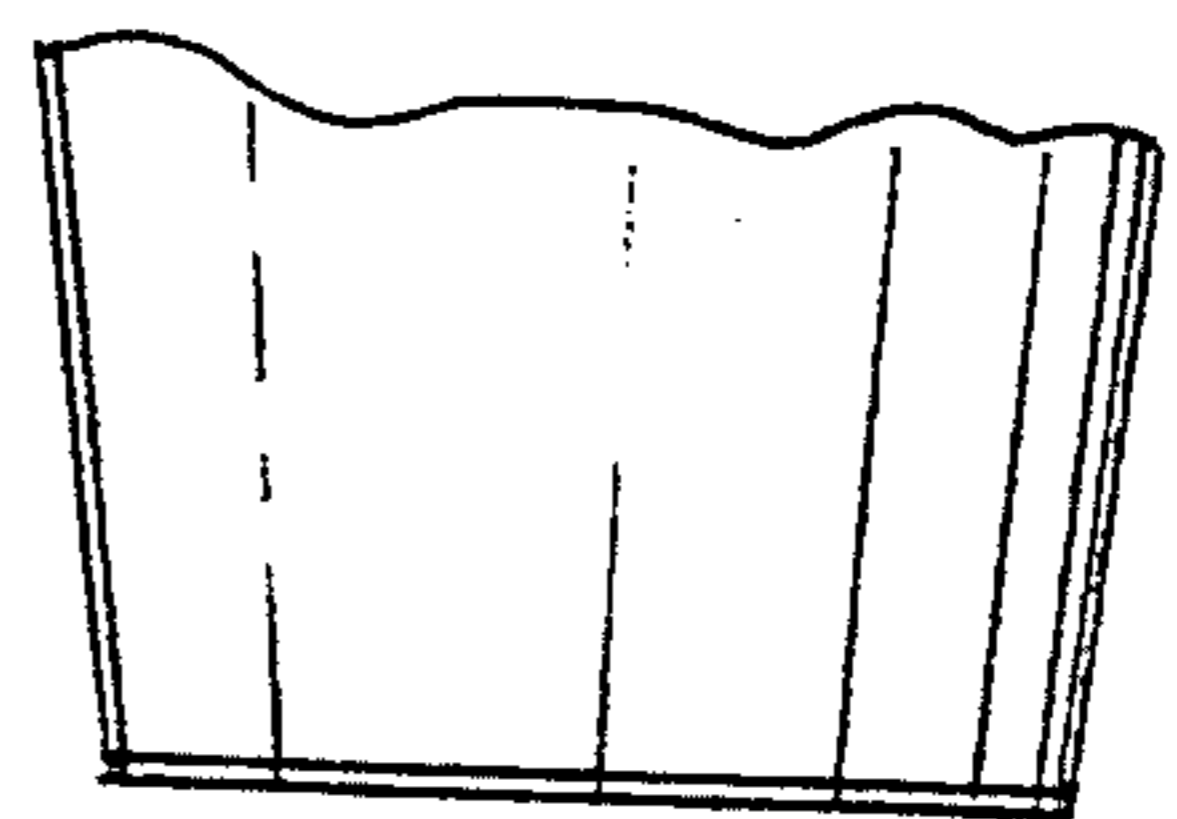

FIG. 5

FIG. 6

