



US00D360330S

United States Patent [19]

Ankeney

[11] Patent Number: Des. 360,330

[45] Date of Patent: ** Jul. 18, 1995

[54] COMPACT DISC DISPLAY

[76] Inventor: Steven C. Ankeney, 1461 N. Placentia Ave., Apt. 43, Fullerton, Calif. 92631

[**] Term: 14 Years

[21] Appl. No.: 20,653

[22] Filed: Mar. 30, 1994

[52] U.S. Cl. D6/629; D6/450; D6/407

[58] Field of Search D6/449, 450, 451, 407, D6/626-635, 475, 476, 466, 467, 479, 512, 396, 405; 211/40-42; 206/387

[56] References Cited

U.S. PATENT DOCUMENTS

- D. 160,657 10/1950 Phillips D6/450
- D. 307,987 5/1990 Bustos D6/450

D. 328,994 9/1992 Jürgens D6/450 X

Primary Examiner—Alan P. Douglas
Assistant Examiner—S. Snapp
Attorney, Agent, or Firm—Roy A. Ekstrand

[57] CLAIM

The ornamental design for a compact disc display, as shown and described.

DESCRIPTION

FIG. 1 sets forth a perspective view of a compact disc display showing the present invention new design; FIG. 2 is a top view thereof; FIG. 3 is a rear view thereof; FIG. 4 is a front view thereof; FIG. 5 is a left side view thereof; FIG. 6 is a right side view thereof; and, FIG. 7 is a bottom view thereof.

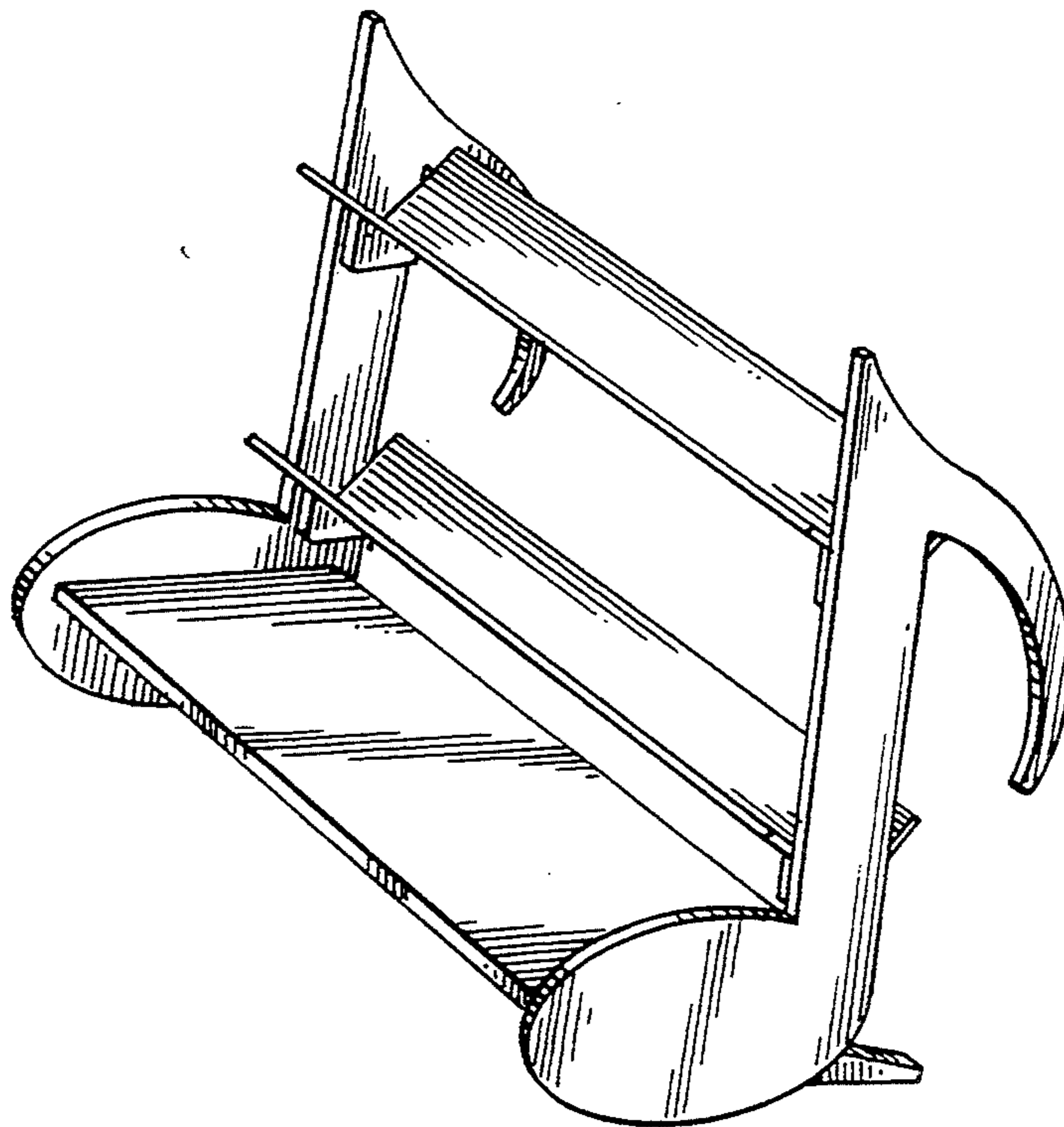

FIG. 1

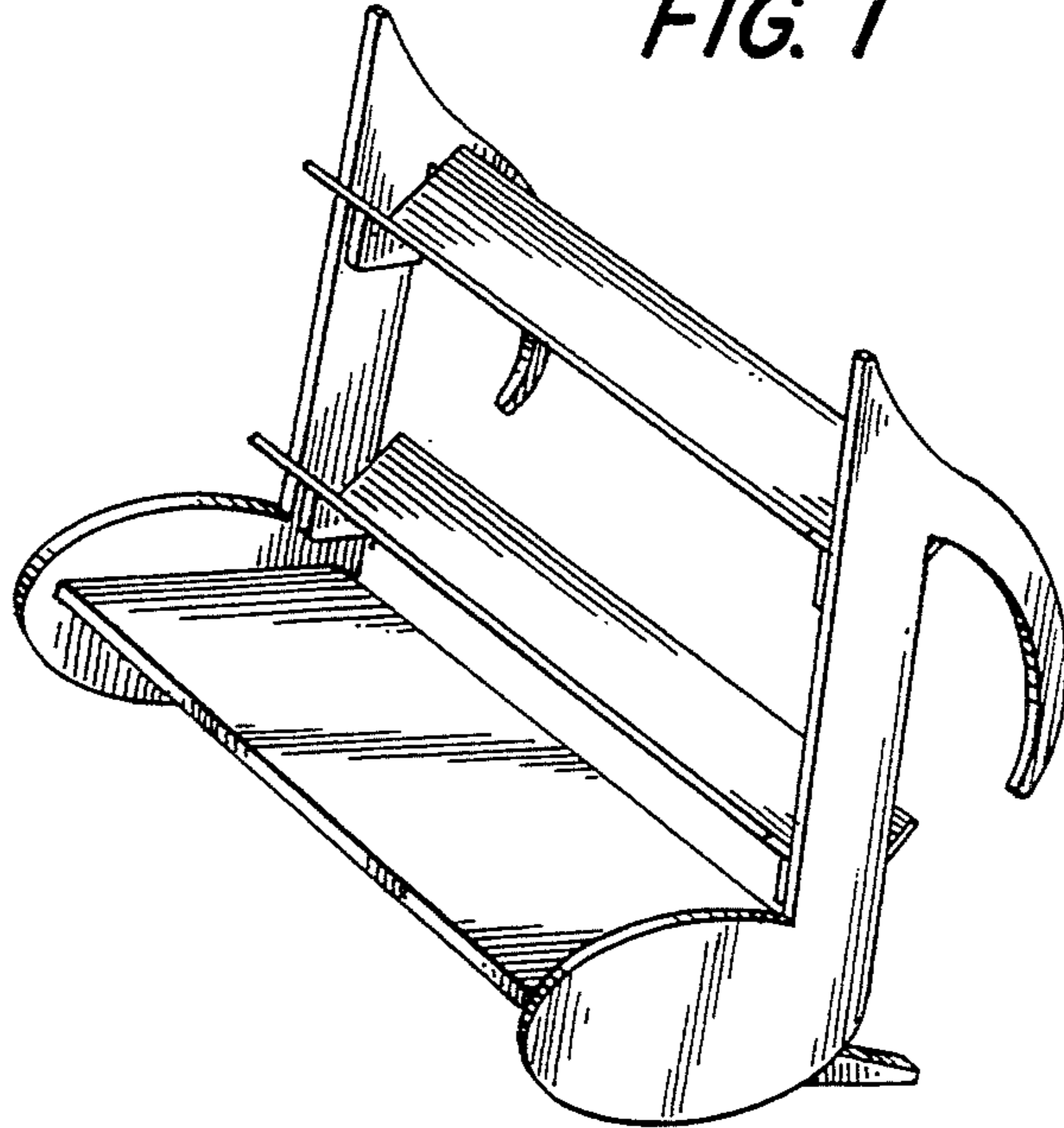

FIG. 2

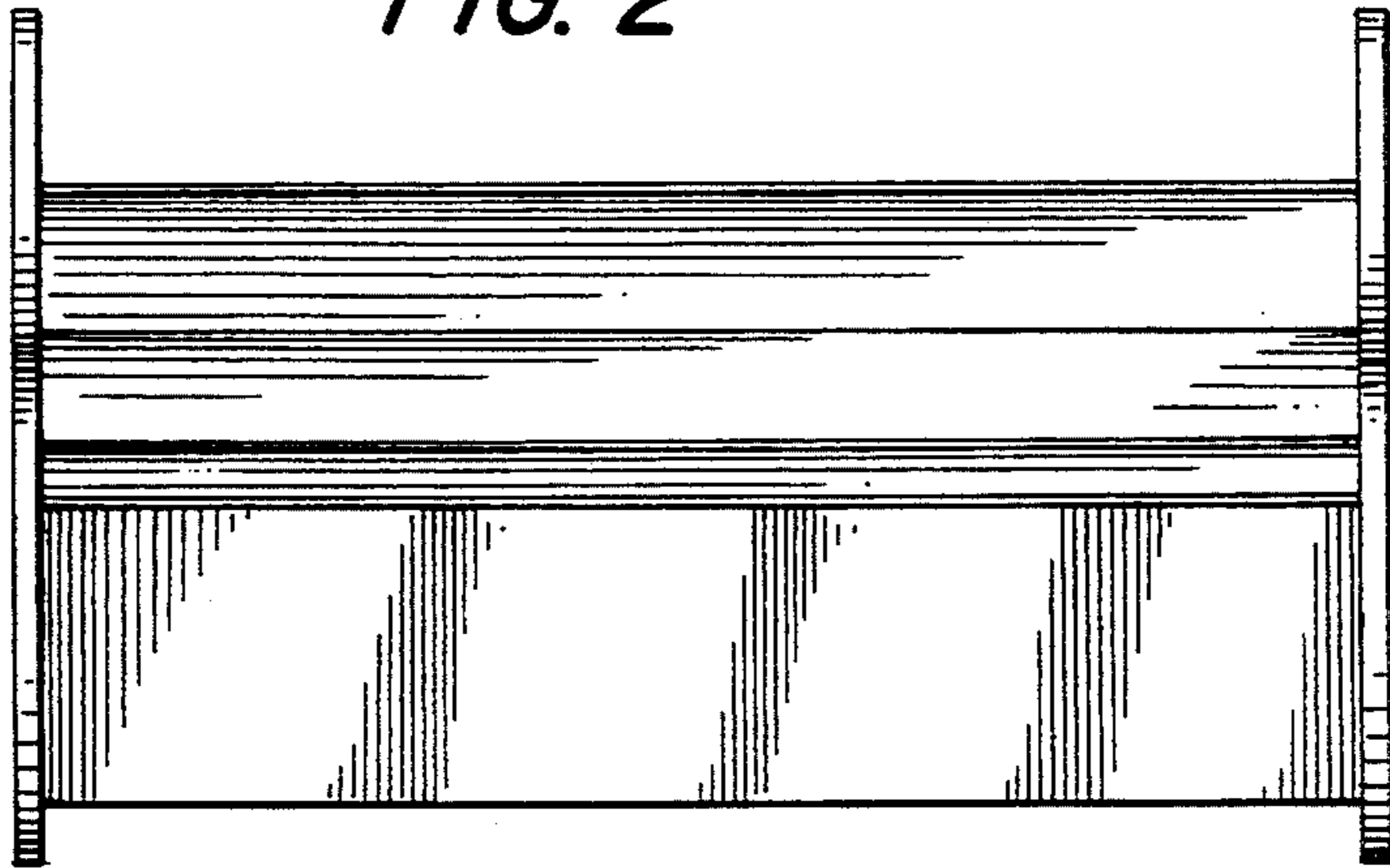

FIG. 3

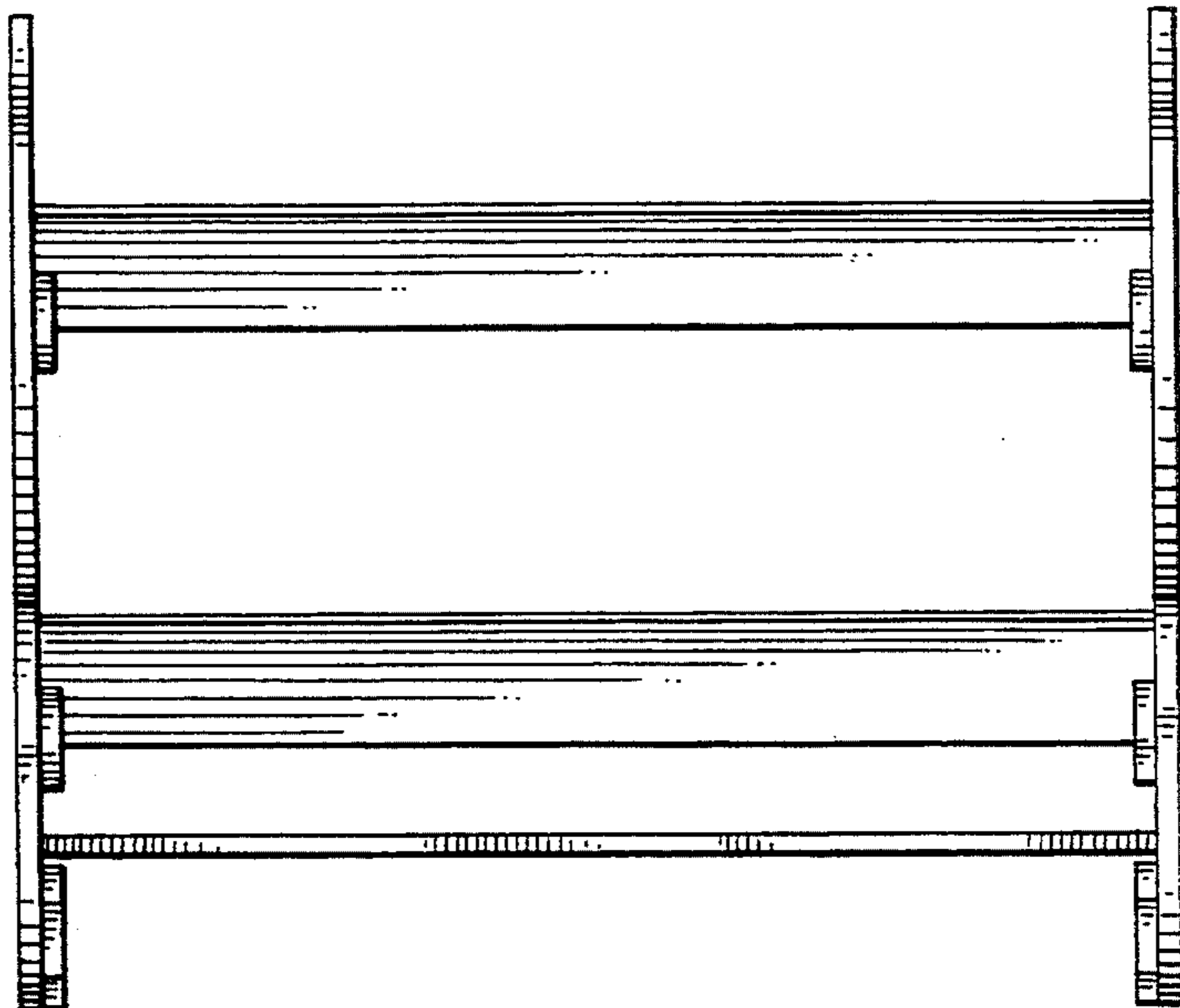

FIG. 6

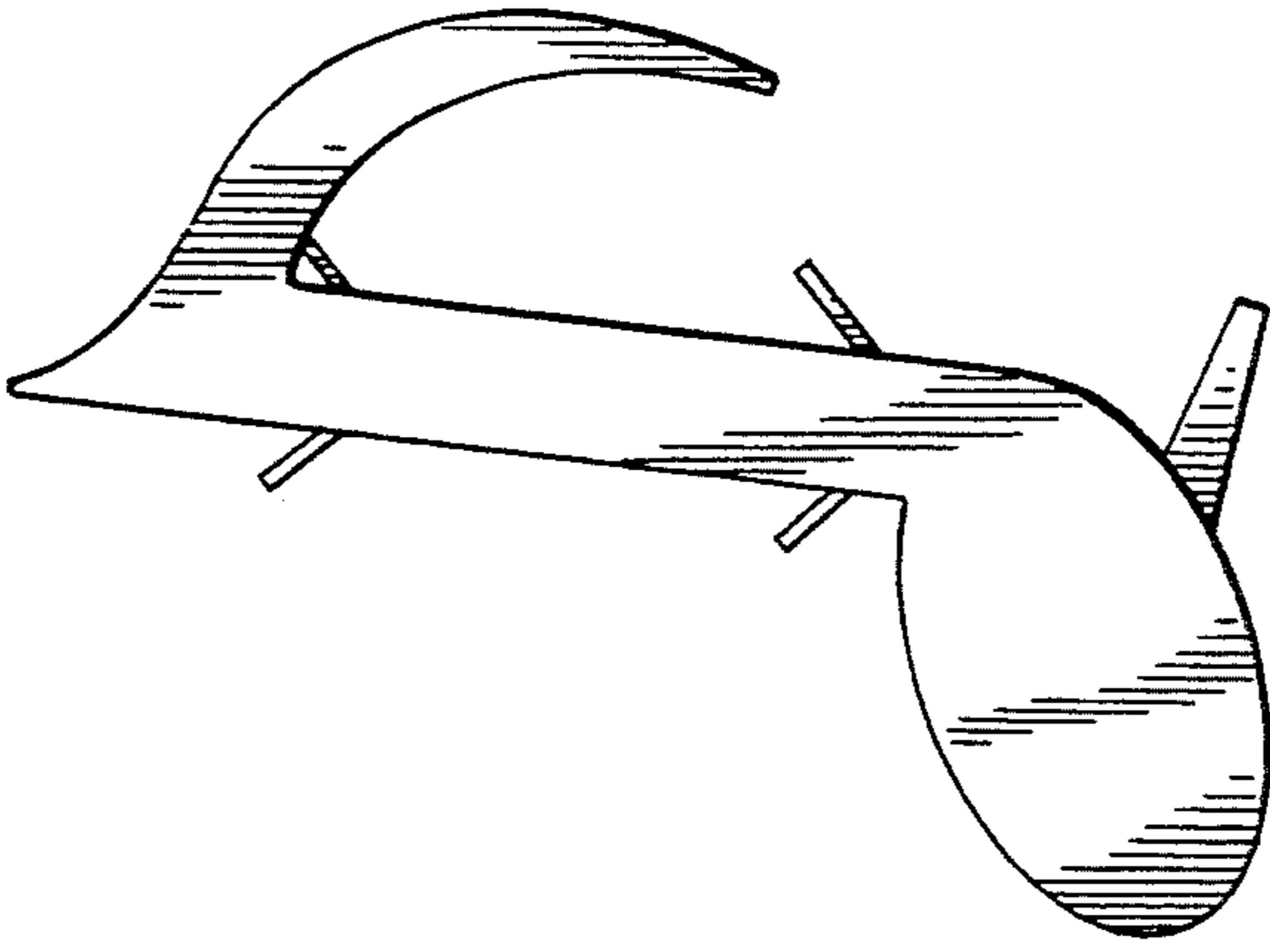

FIG. 4

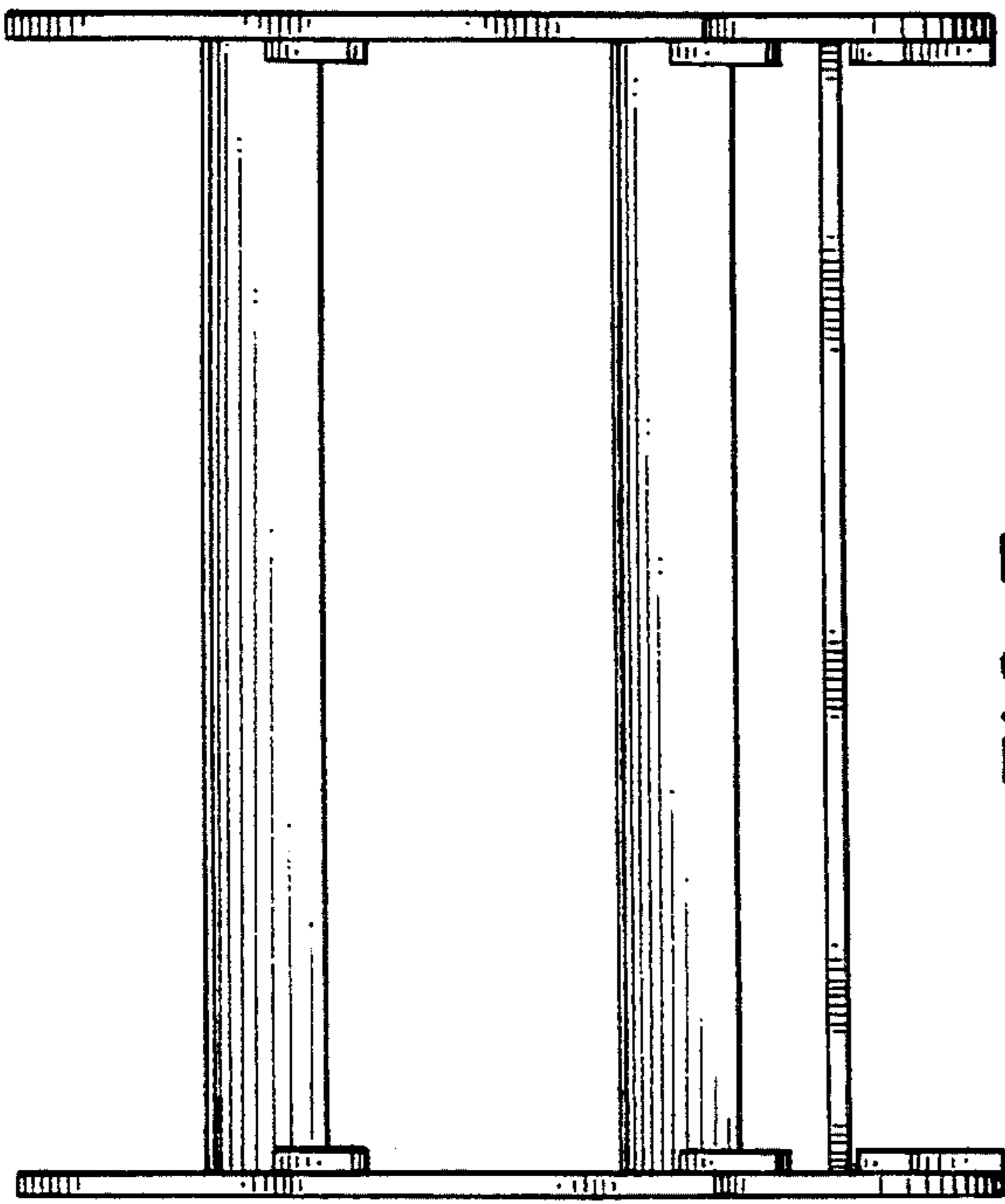

FIG. 7

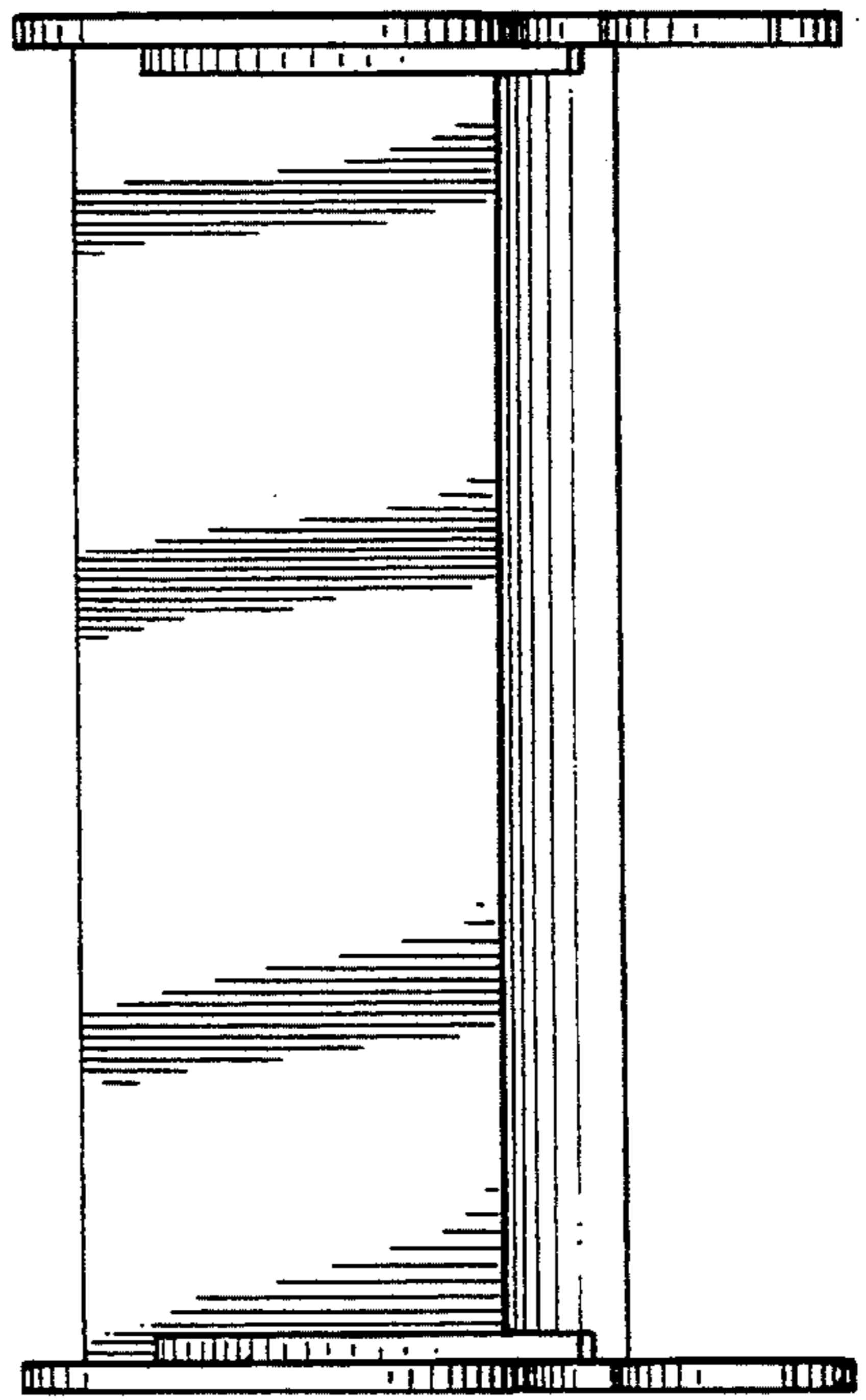

FIG. 5

