



US00D360279S

United States Patent [19] Yeh

[11] Patent Number: Des. 360,279
[45] Date of Patent: ** Jul. 11, 1995

[54] HALOGEN TORCHIERE

[76] Inventor: John Yeh, 660 S. Aberdeen, Anaheim Hills, Calif. 90266

[**] Term: 14 Years

[21] Appl. No.: 20,395

[22] Filed: Mar. 25, 1994

[52] U.S. Cl. D26/110; D26/131

[58] Field of Search D26/93, 102-112, D26/113, 72, 80-92, 128-137; 362/410-414, 147, 404-408

[56] References Cited

U.S. PATENT DOCUMENTS

D. 23,808	11/1894	Wilder	D26/134
D. 63,536	12/1923	Warman	D26/88
D. 119,822	4/1940	Sheerer	D26/134
D. 120,022	4/1940	Sheerer	D26/133
D. 171,021	12/1953	Arch	D26/105
5,016,154	5/1991	Leeyeh	362/414

OTHER PUBLICATIONS

Abitare, Dec. 1988, p. 192, Prezzo Floor Lamp, Triangular Openings in Shade.

Home Lighting & Accessories, Dec. 1992, p. 86, Cambridge Floor Lamp Head.

House Beautiful, Nov. 1953, p. 339, Ceiling Light, Square Openings in Shade.

Primary Examiner—Susan J. Lucas

Attorney, Agent, or Firm—Francis X. LoJacono

[57] CLAIM

The ornamental design for a halogen torchiere, as shown and described.

DESCRIPTION

FIG. 1 a front-perspective view of a halogen torchiere, showing my new design thereof;
 FIG. 2 is a top plan view thereof;
 FIG. 3 is a rear-elevational view thereof;
 FIG. 4 is a bottom plan view thereof;
 FIG. 5 a front-perspective view of an alternative embodiment of the present invention of a halogen torchiere;
 FIG. 6 is a top plan view thereof;
 FIG. 7 is a rear-elevational view thereof;
 FIG. 8 is a bottom plan view thereof;
 FIG. 9 a front-perspective view of an alternative embodiment of the present invention of a halogen torchiere;
 FIG. 10 is a top plan view thereof;
 FIG. 11 is a rear-elevational view thereof;
 FIG. 12 is a bottom plan view thereof;
 FIG. 13 a front-perspective view of an alternative embodiment of the present invention of a halogen torchiere;
 FIG. 14 is a top plan view thereof;
 FIG. 15 is a rear-elevational view thereof;
 FIG. 16 is a bottom plan view thereof;
 FIG. 17 a front-perspective view of an alternative embodiment of the present invention of a halogen torchiere;
 FIG. 18 is a top plan view thereof;
 FIG. 19 is a rear-elevational view thereof; and,
 FIG. 20 is a bottom plan view thereof.

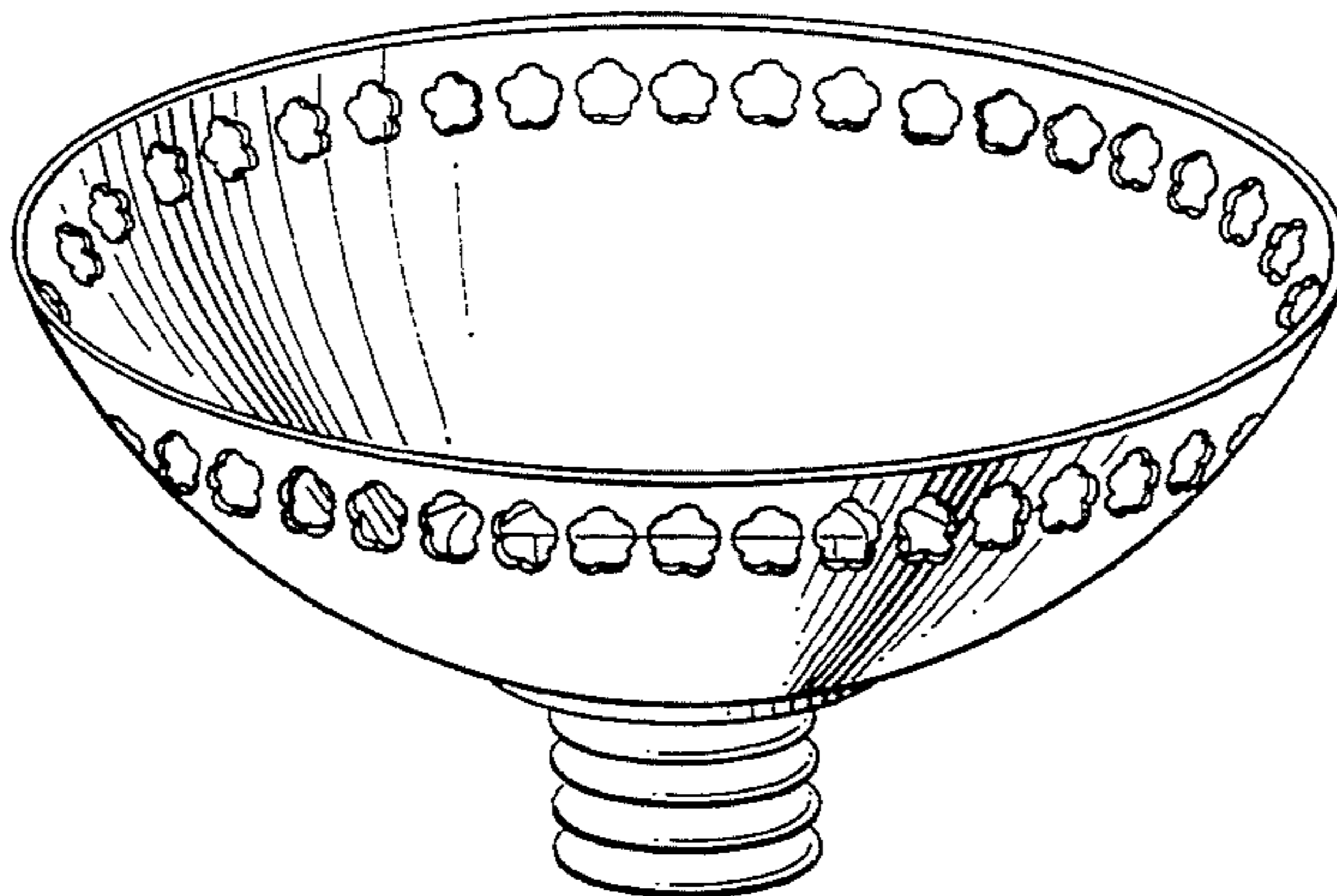
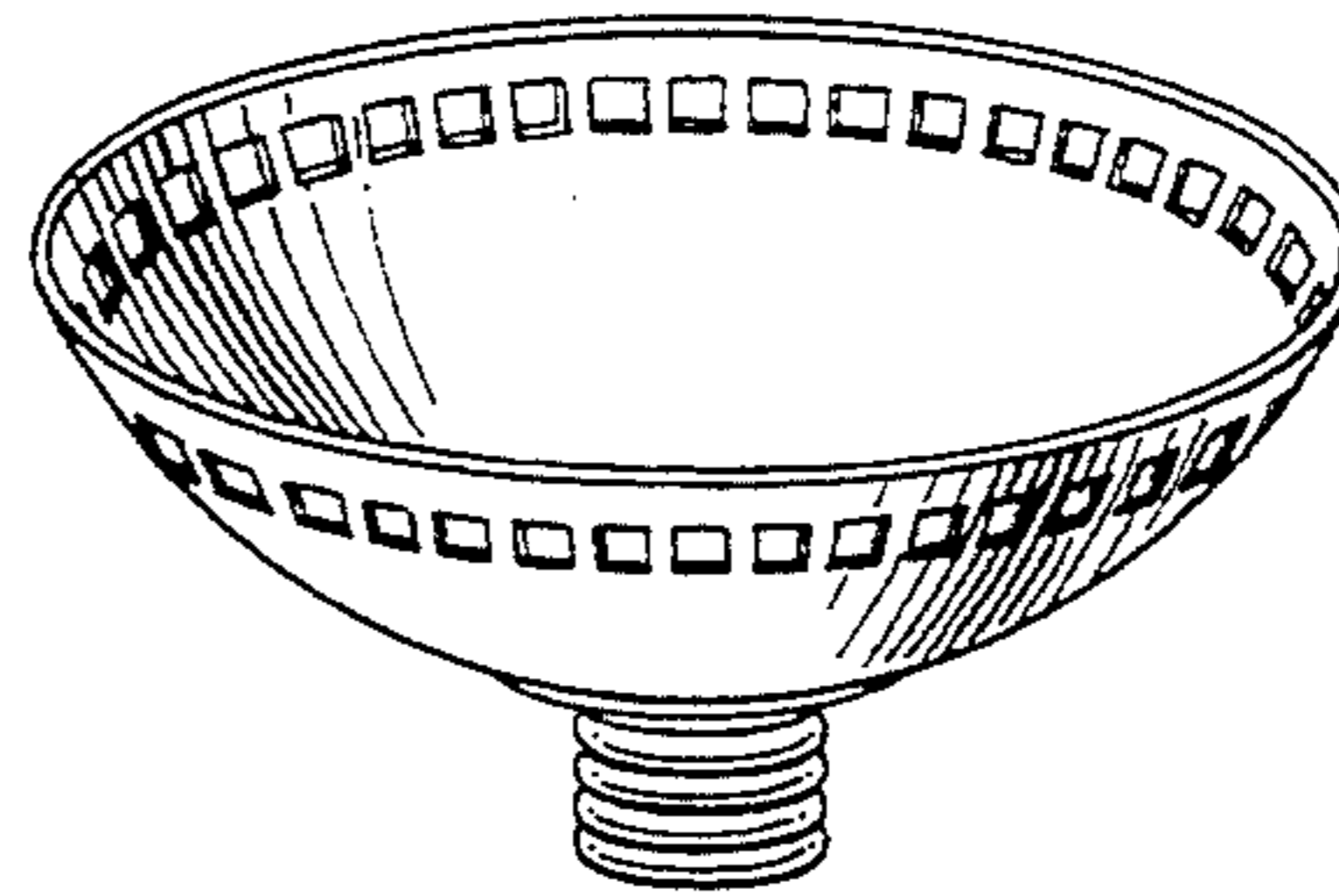
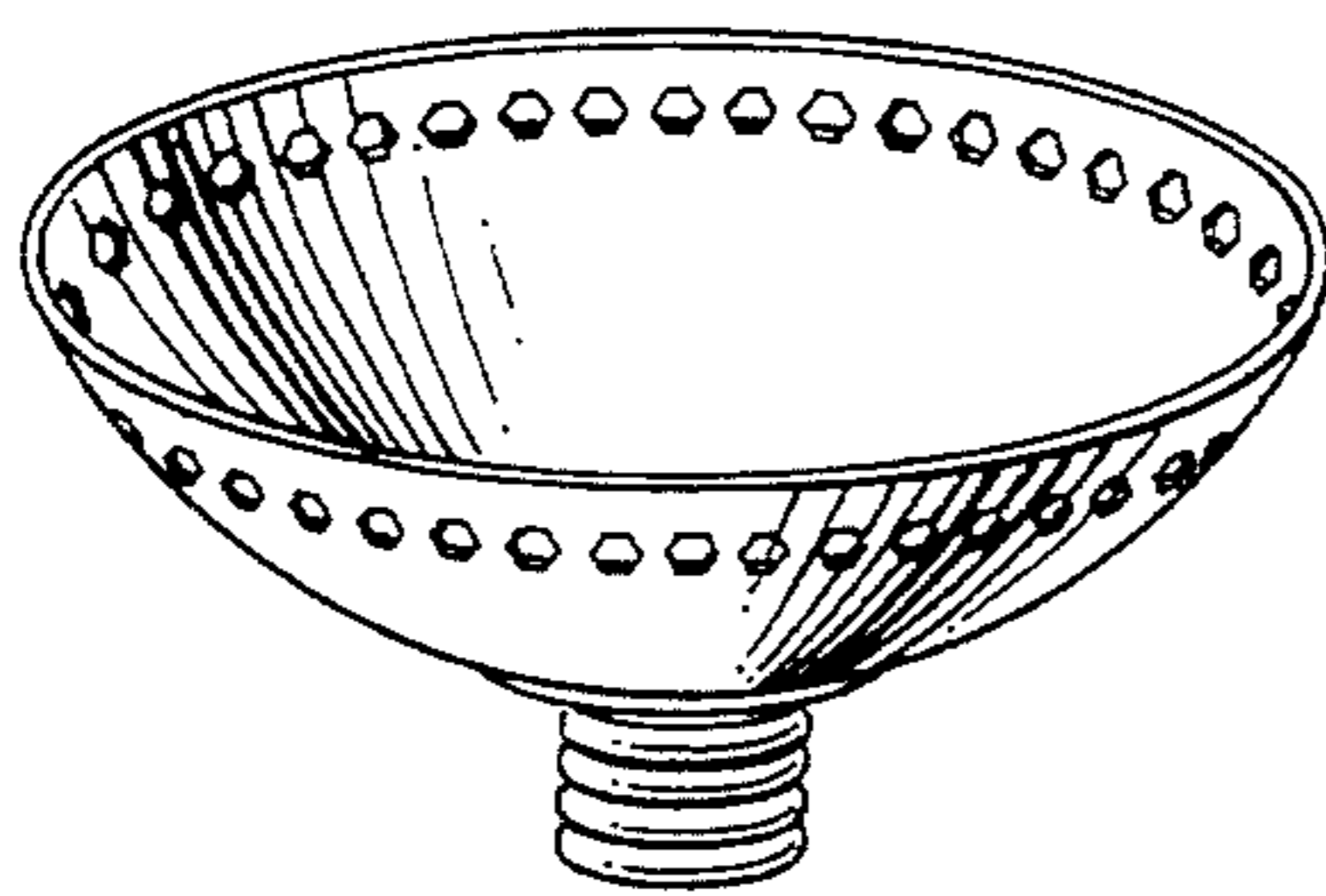

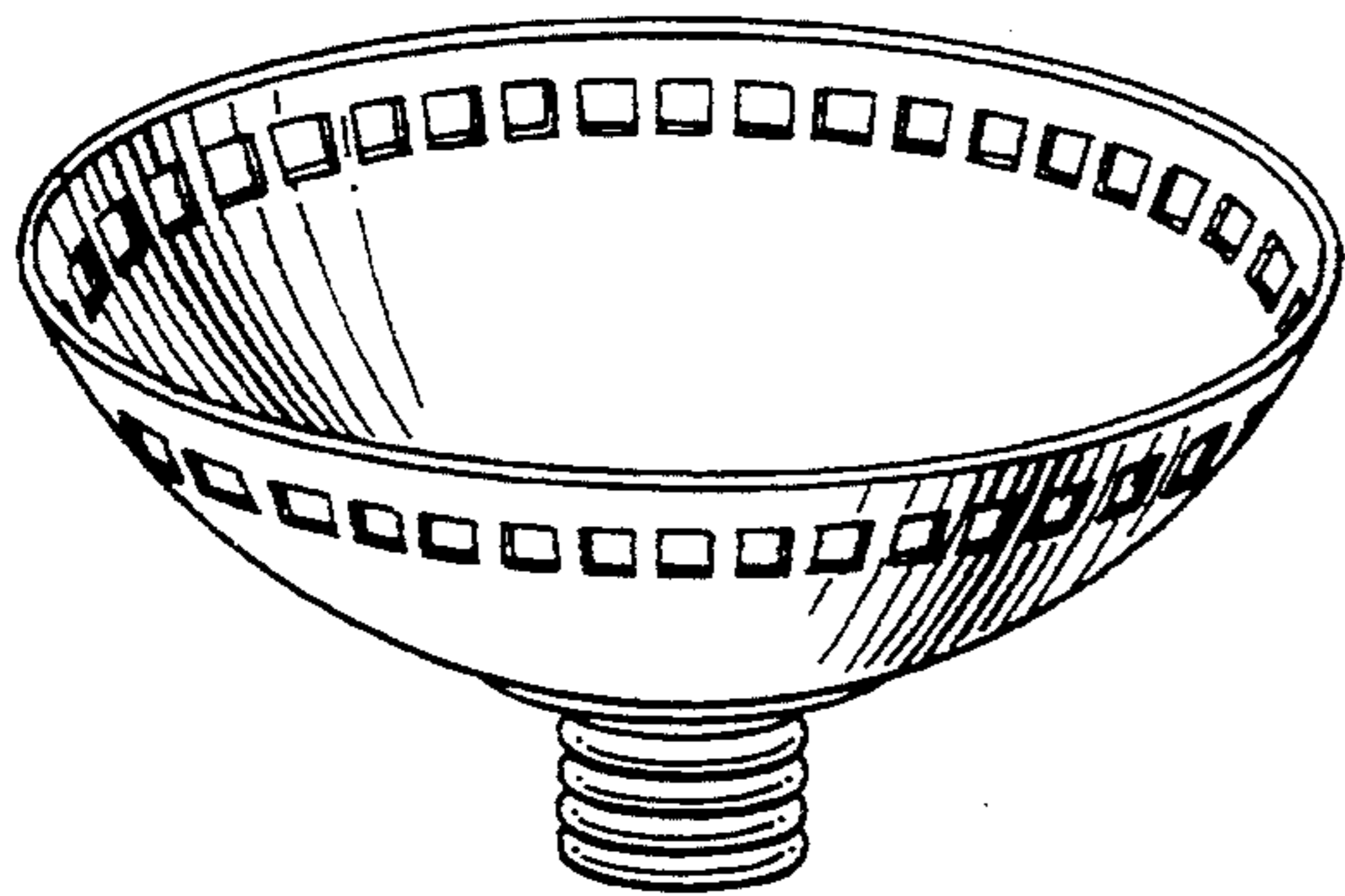

FIG. 1

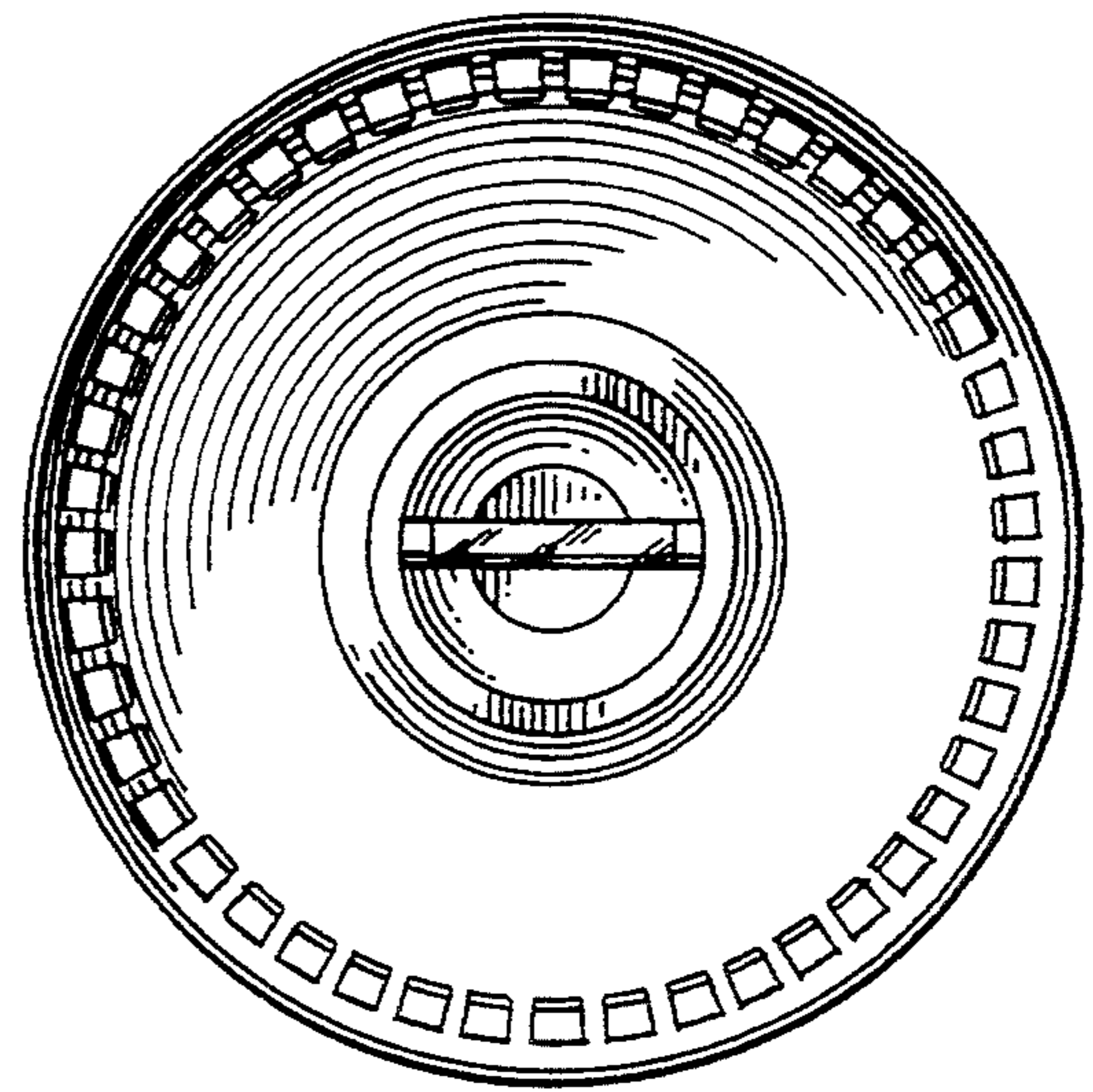

FIG. 2

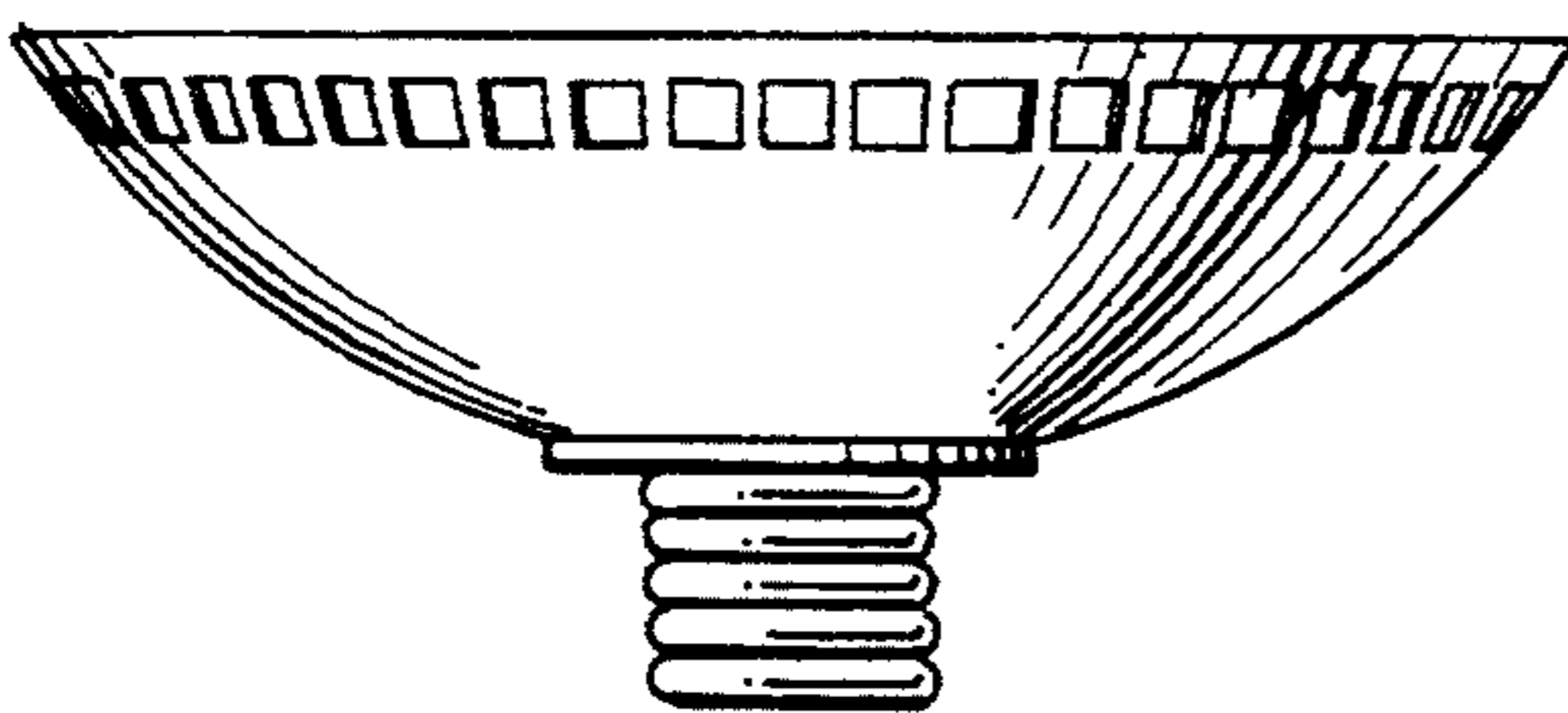

FIG. 3

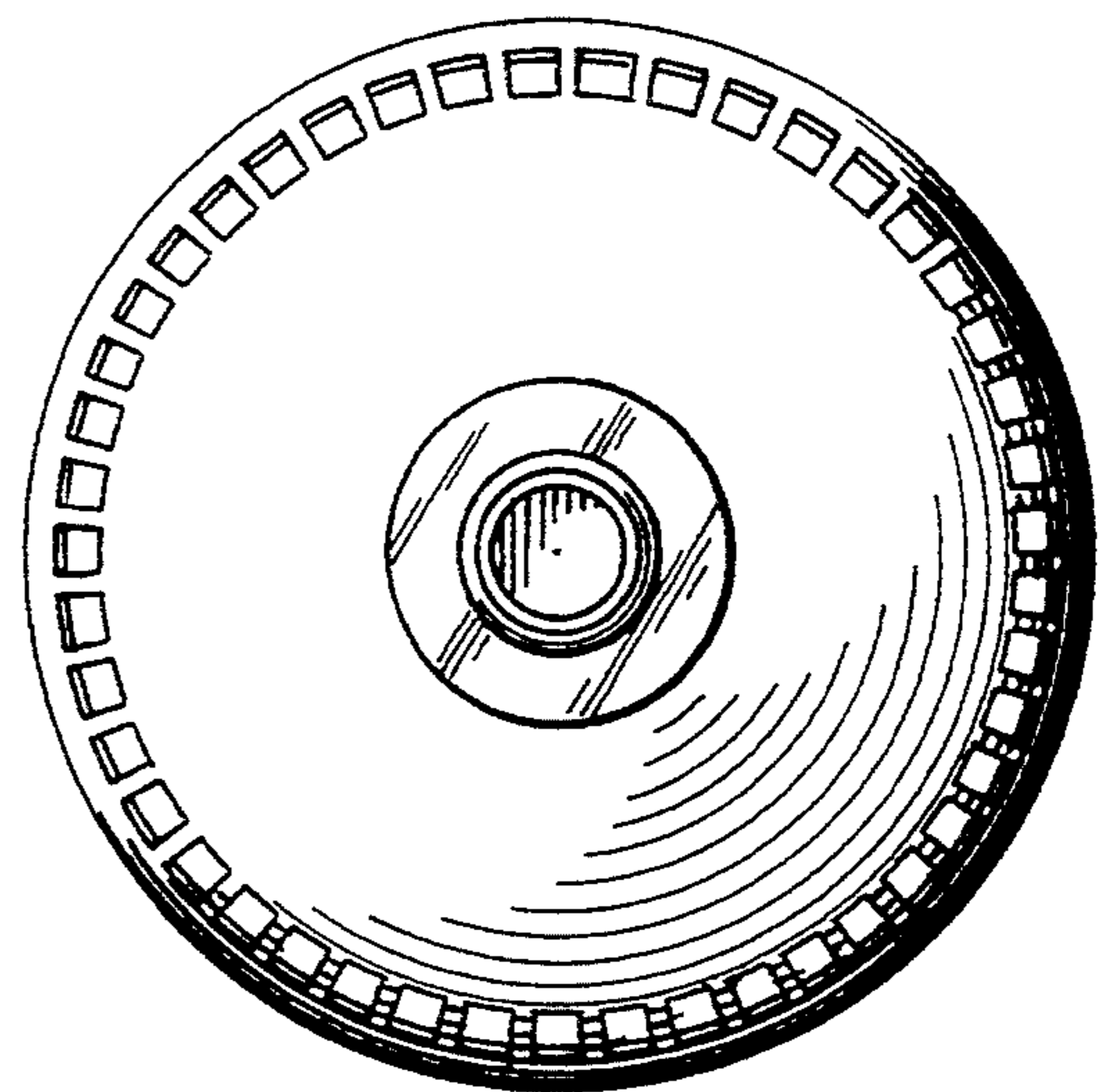

FIG. 4

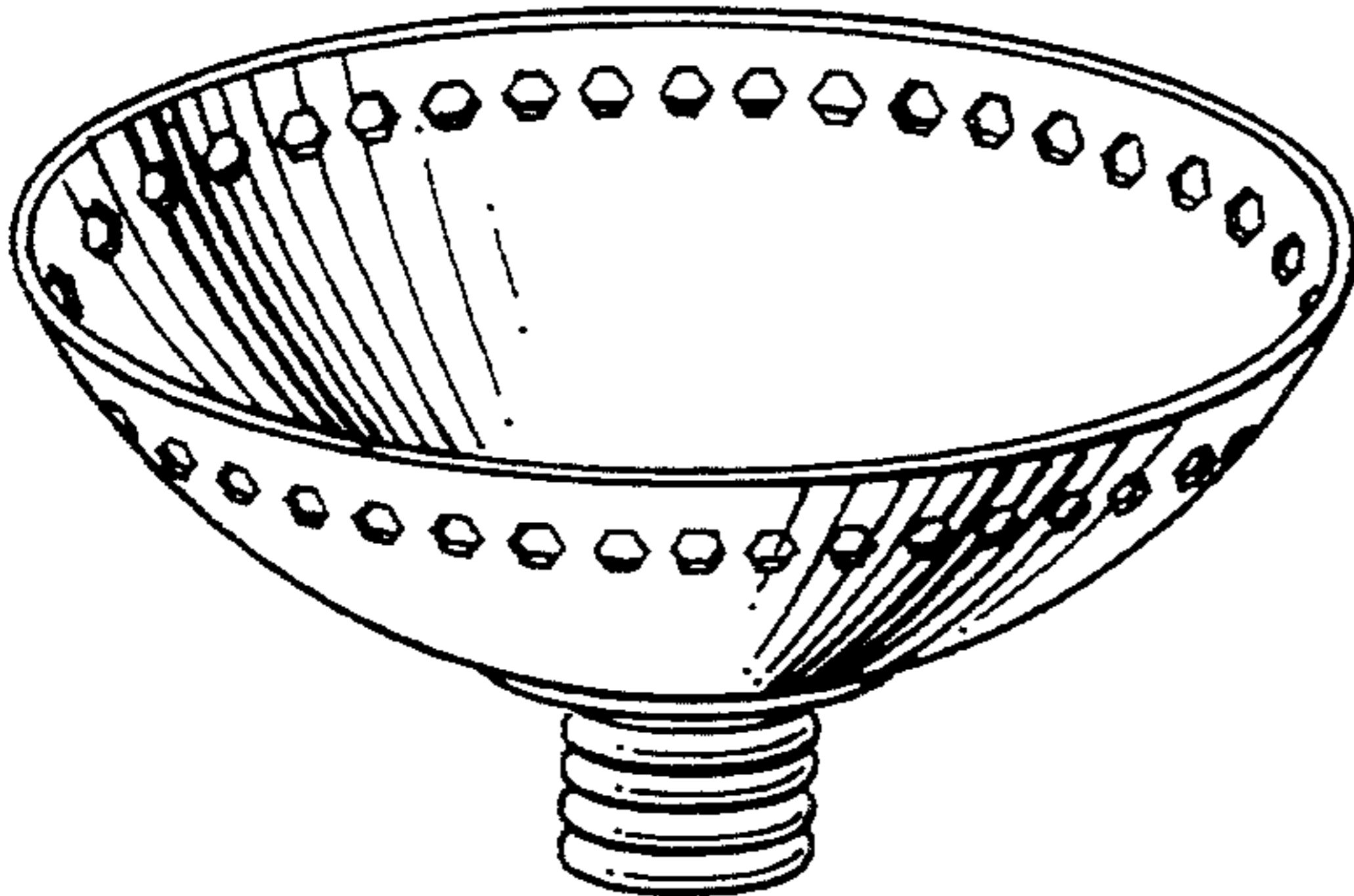

FIG. 5

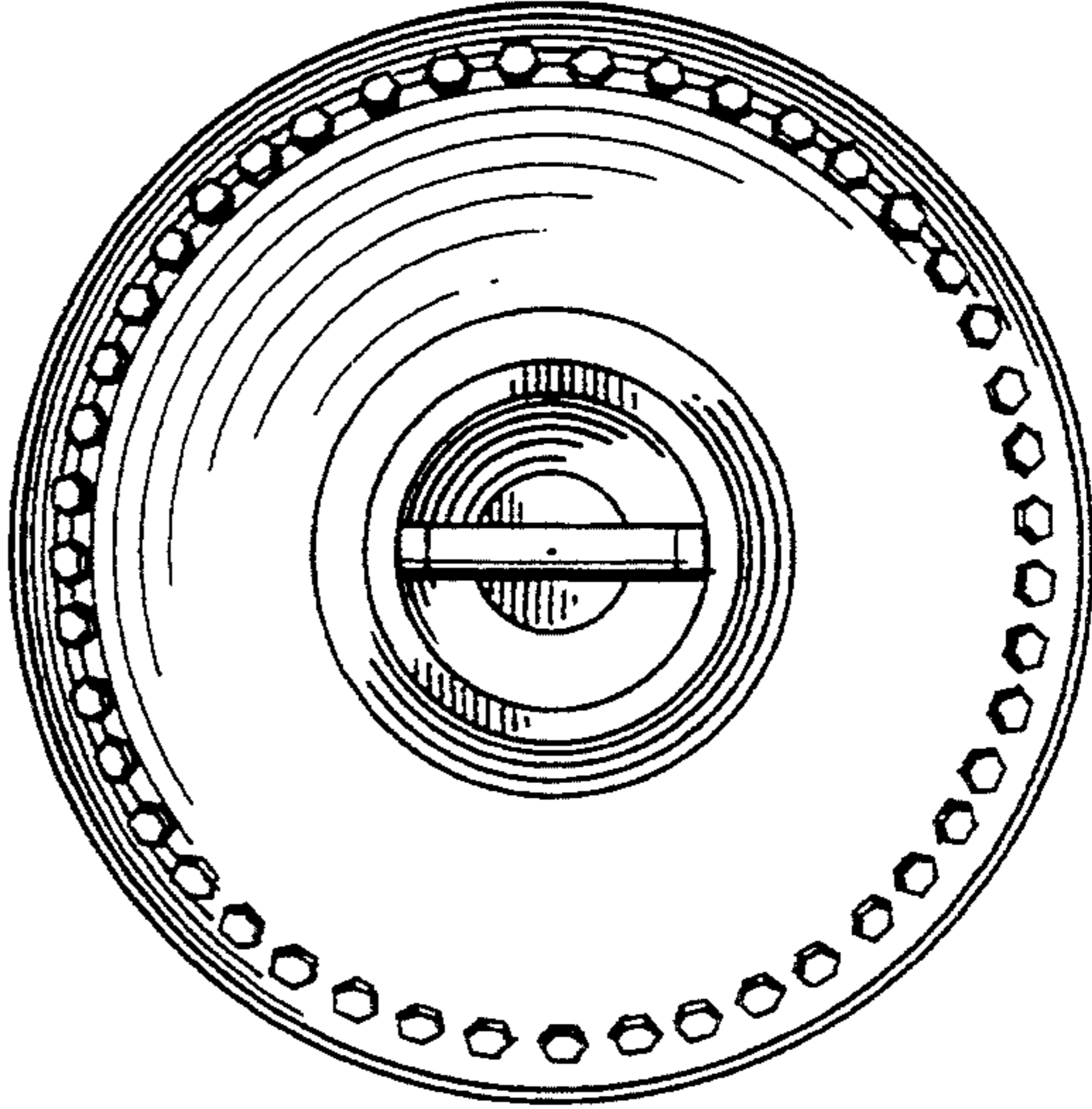

FIG. 6

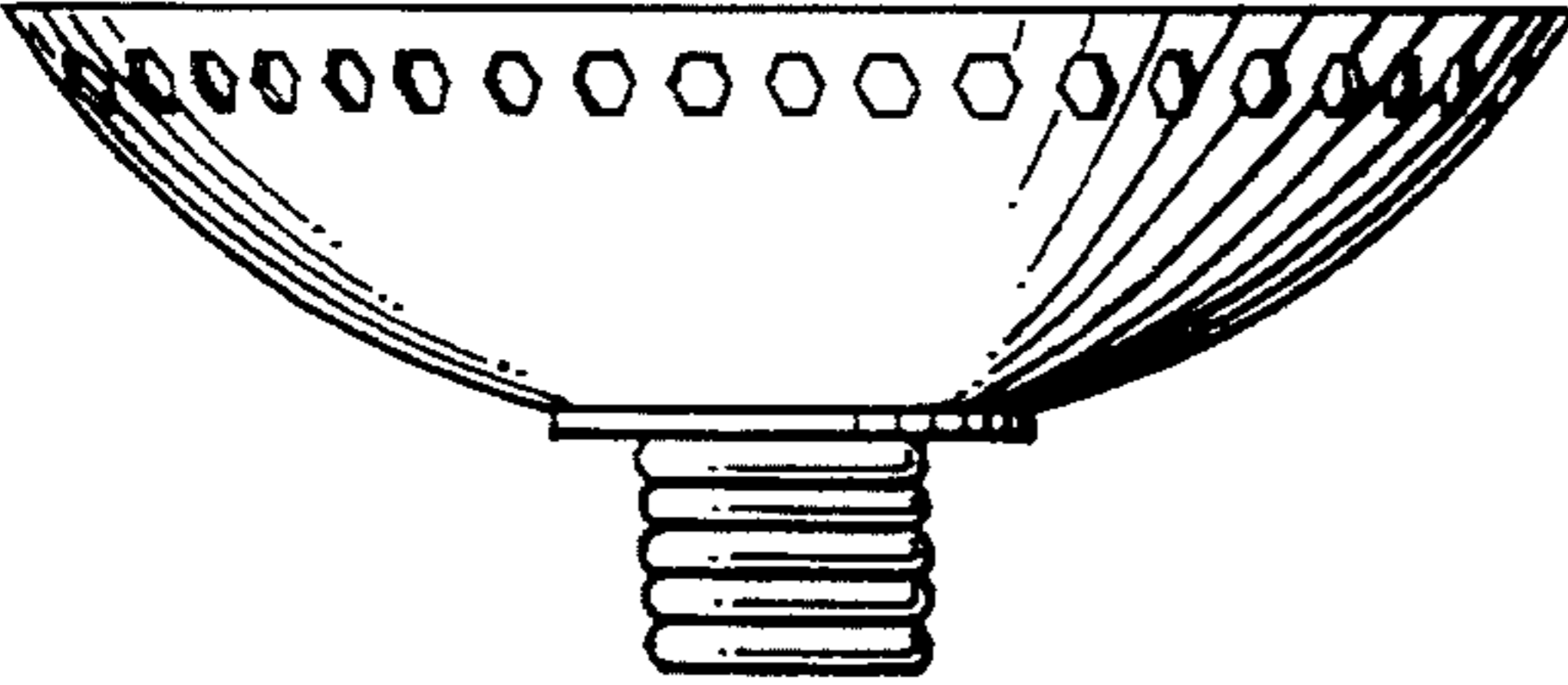

FIG. 7

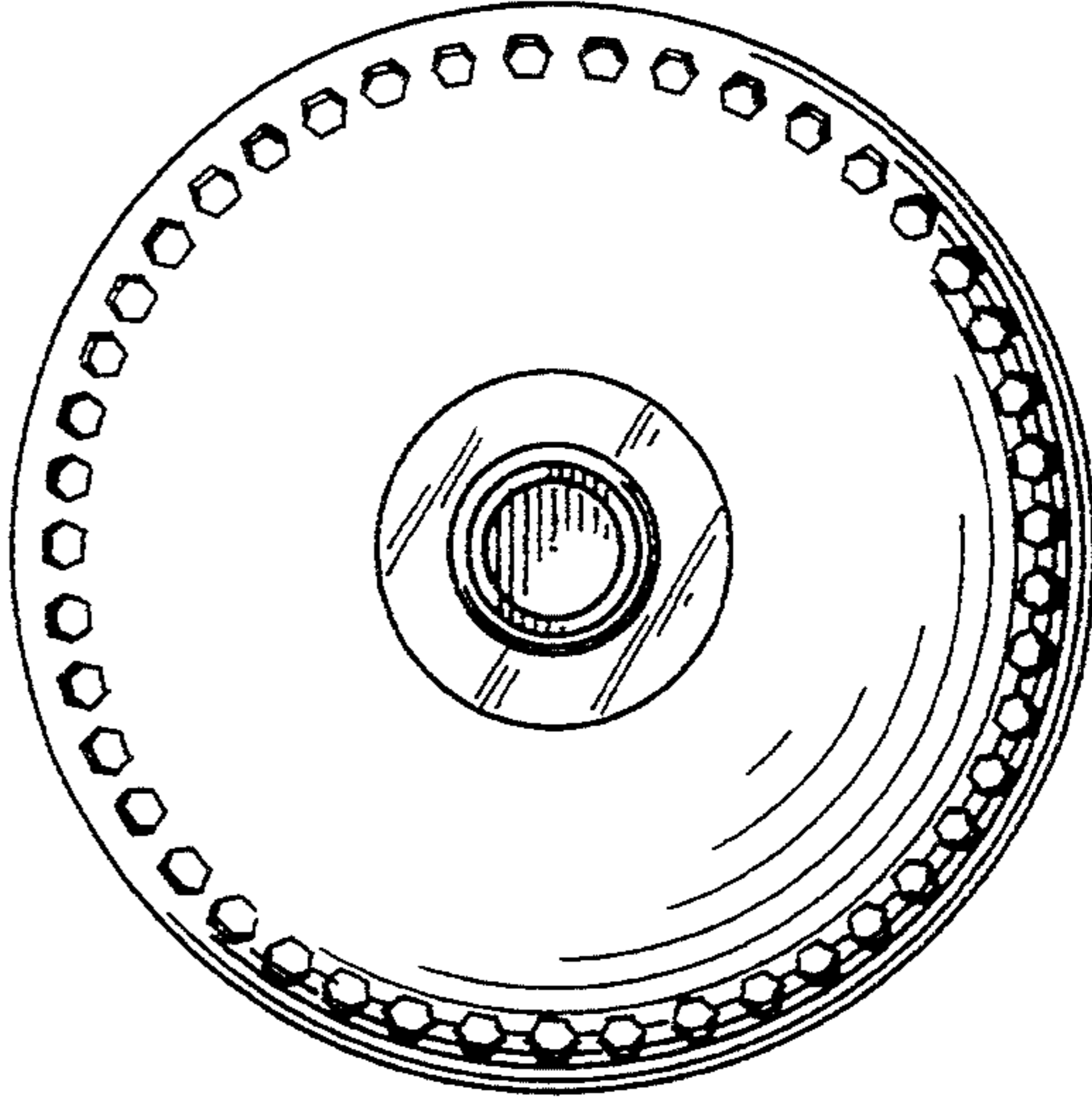

FIG. 8

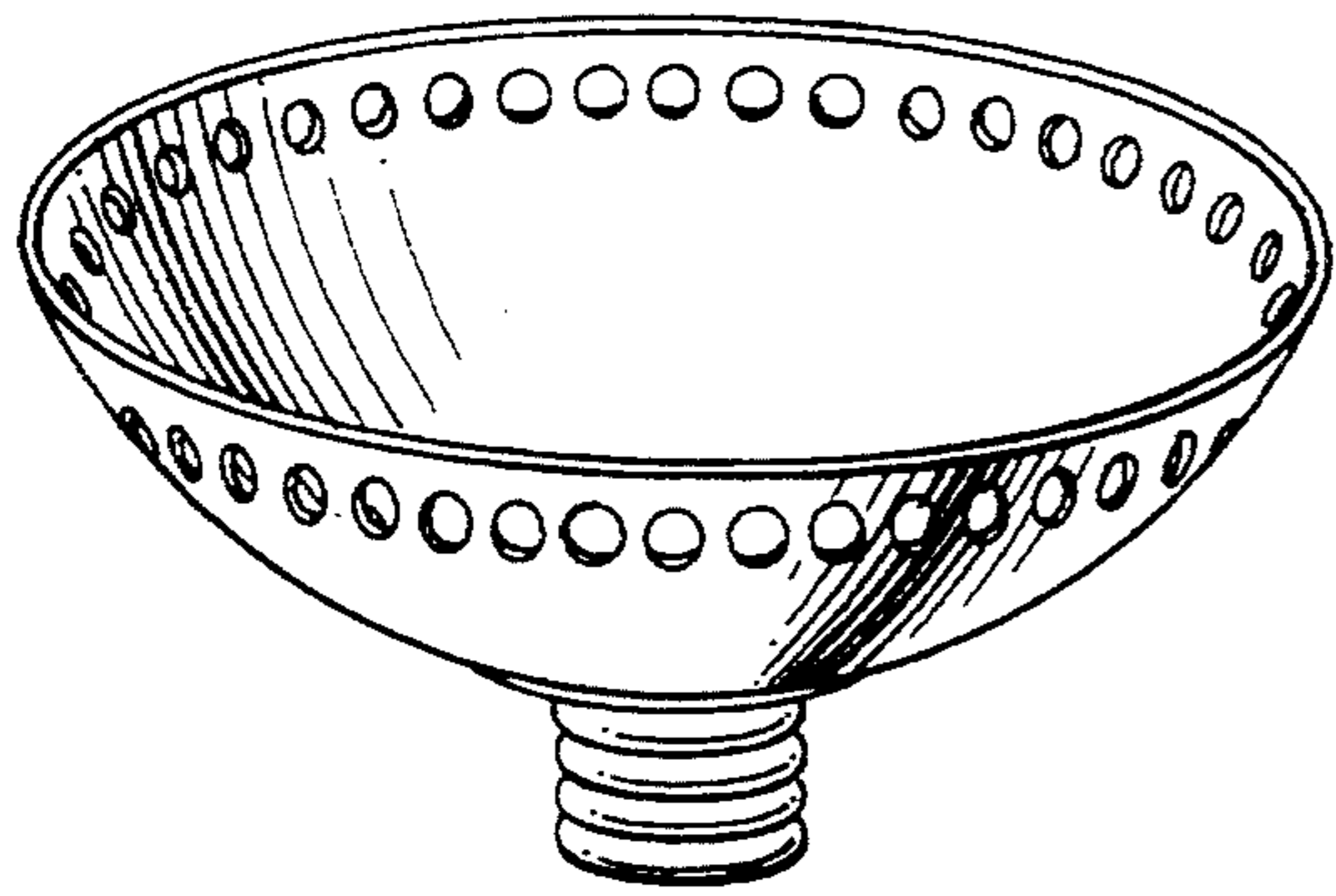

FIG. 9

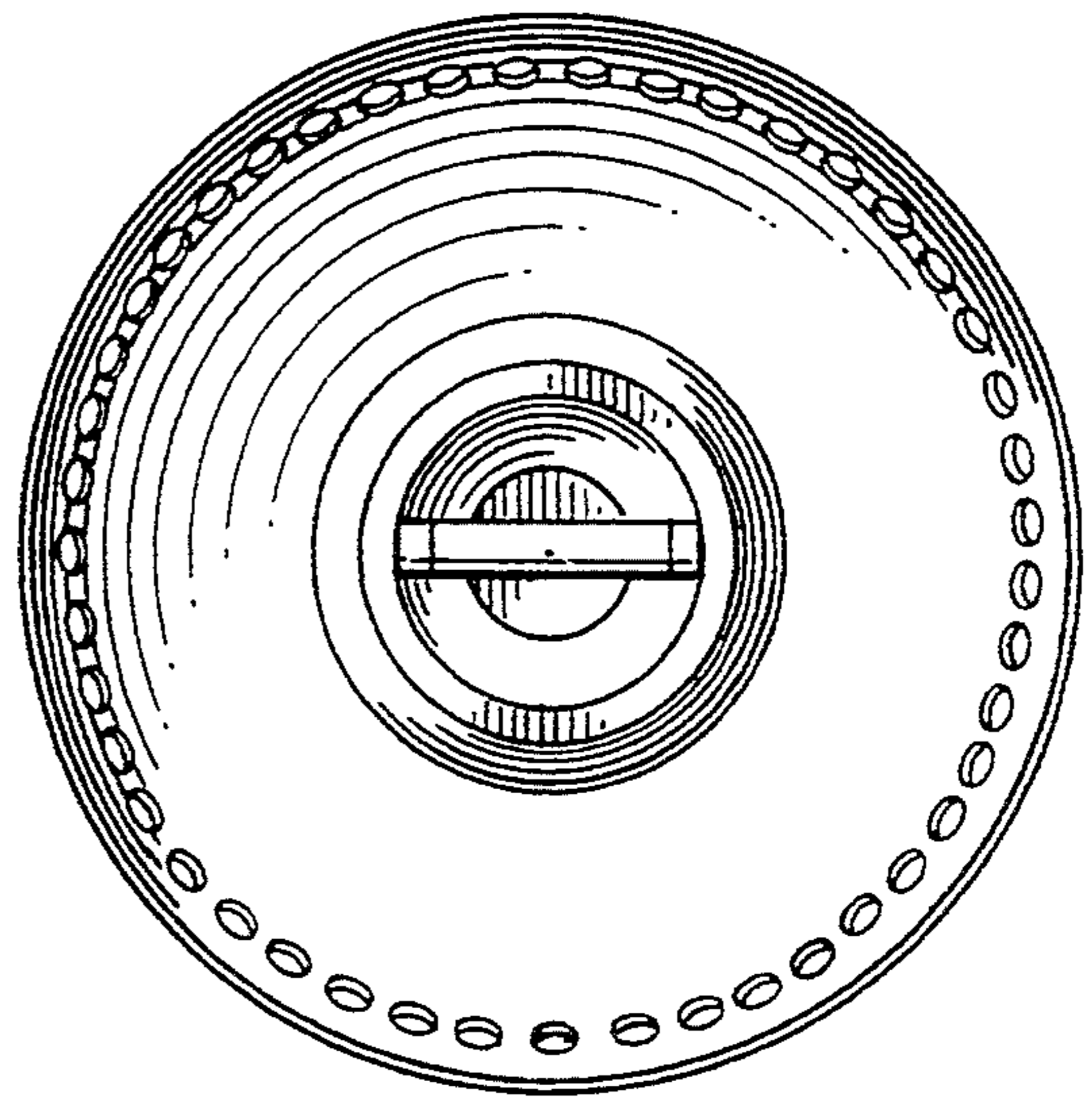

FIG. 10

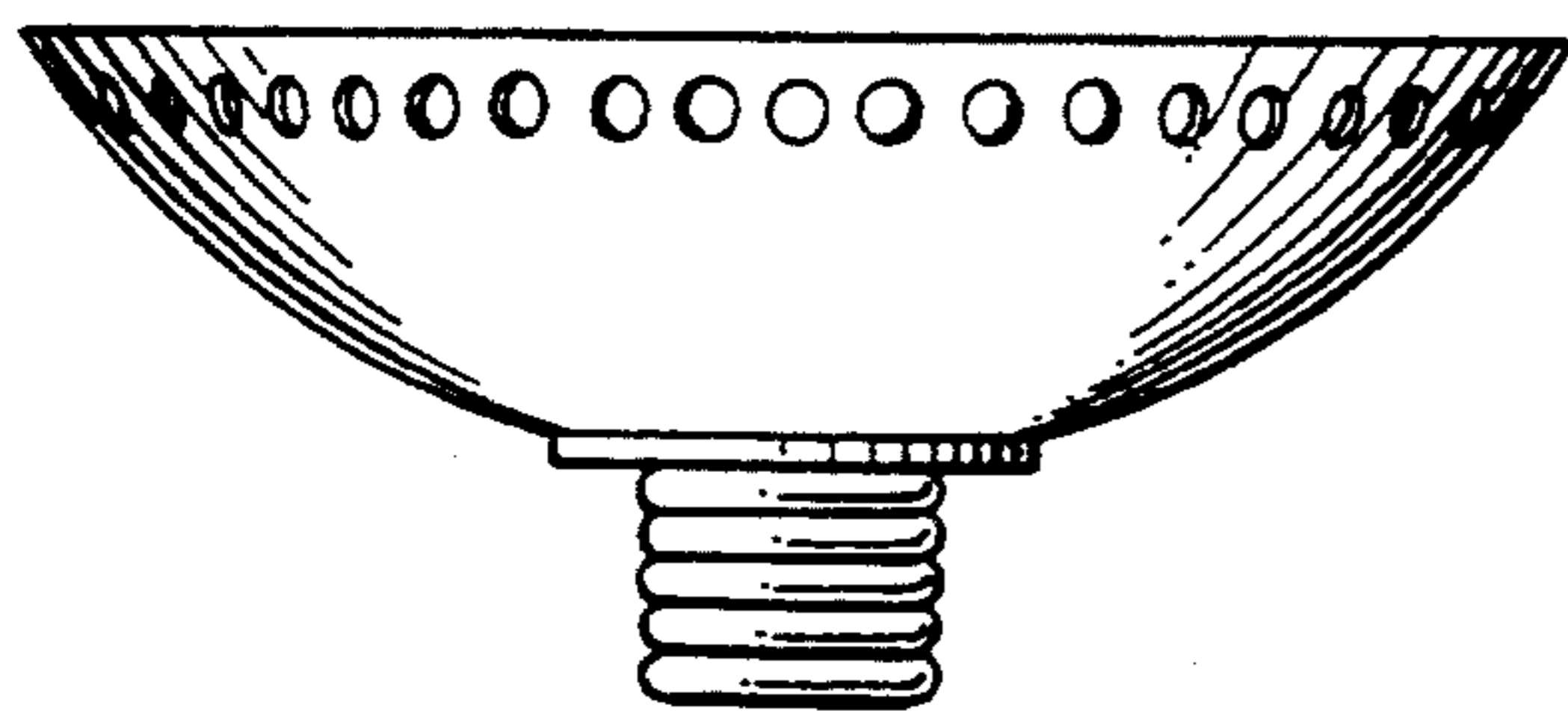

FIG. 11

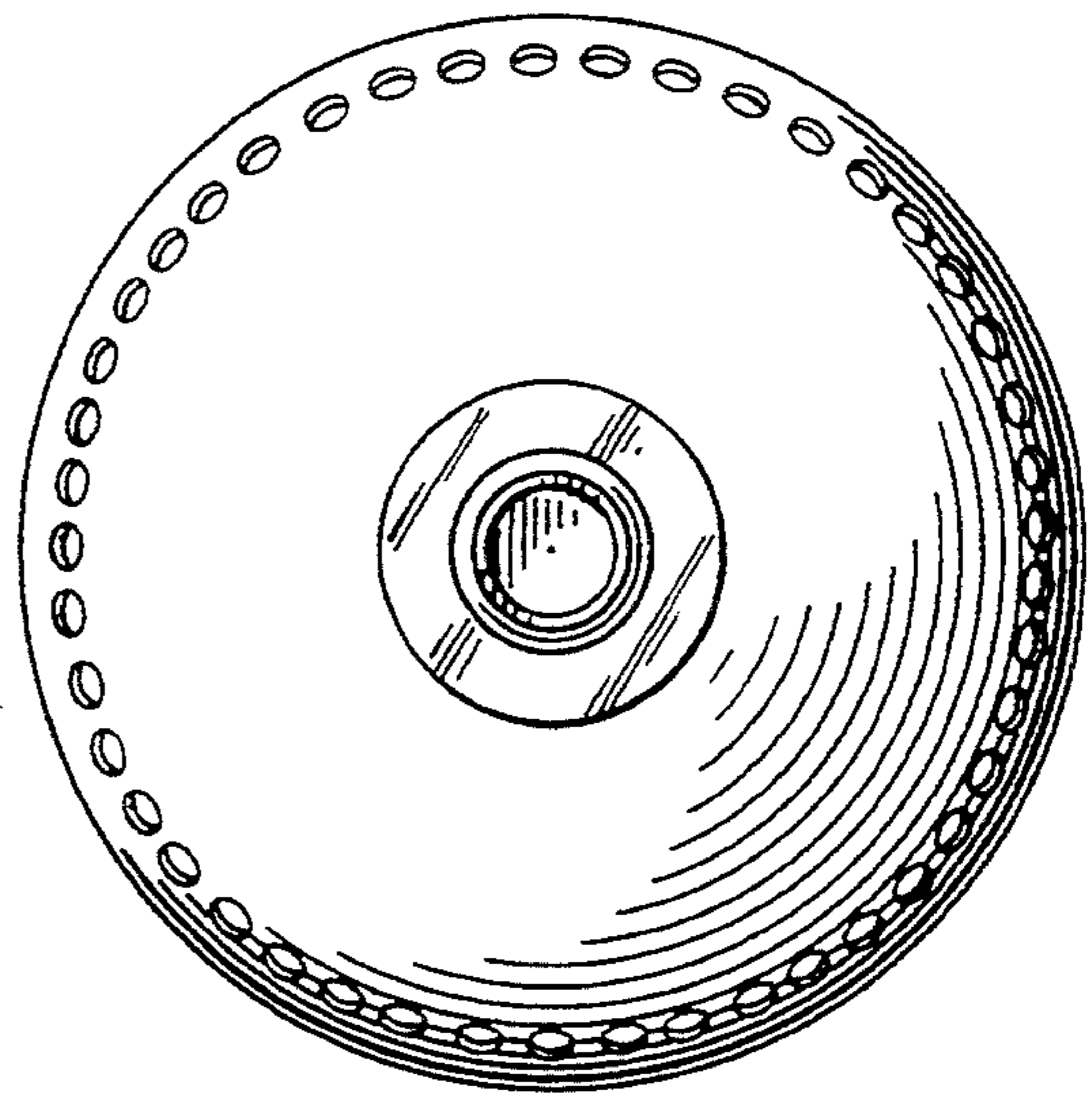

FIG. 12

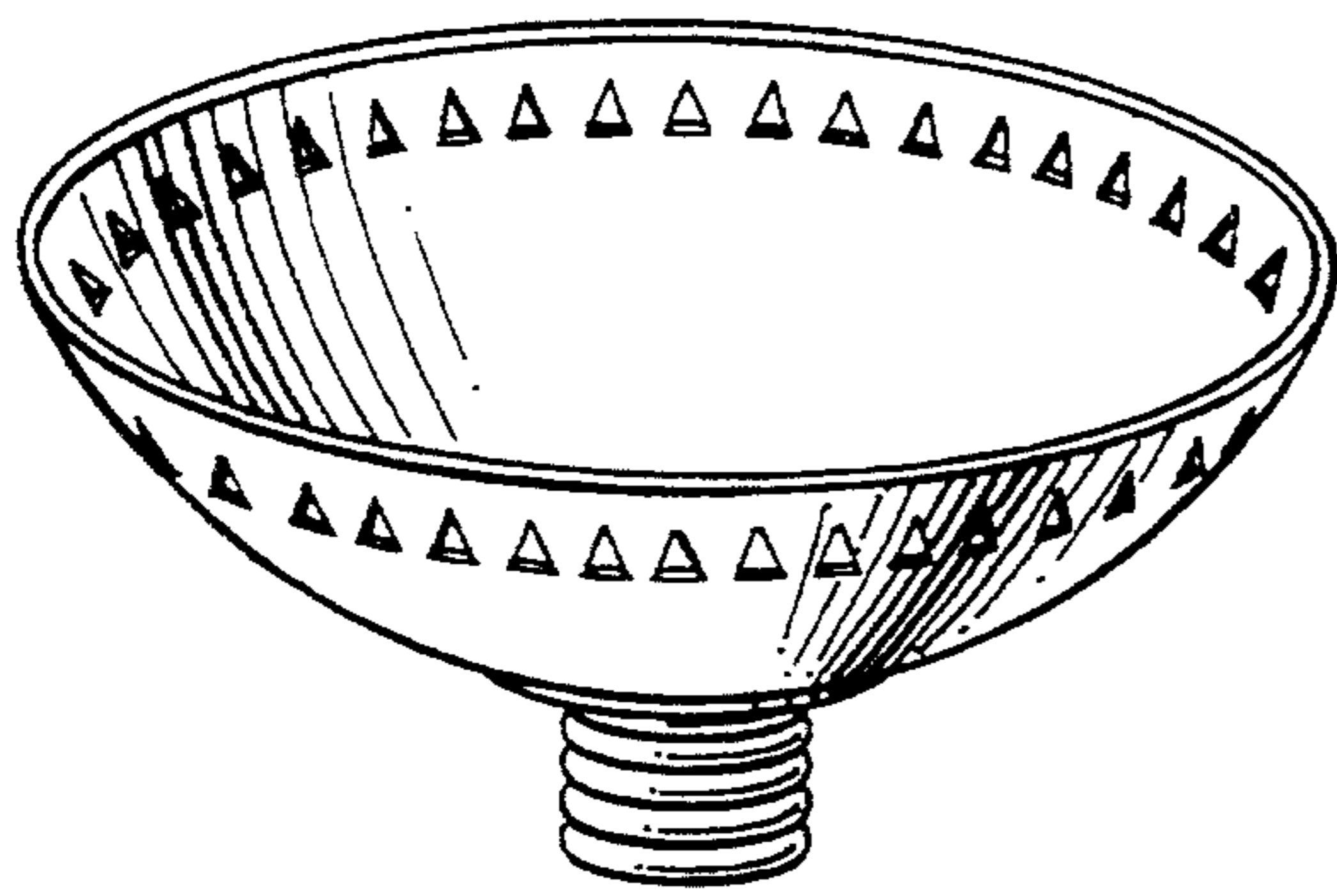

FIG. 13

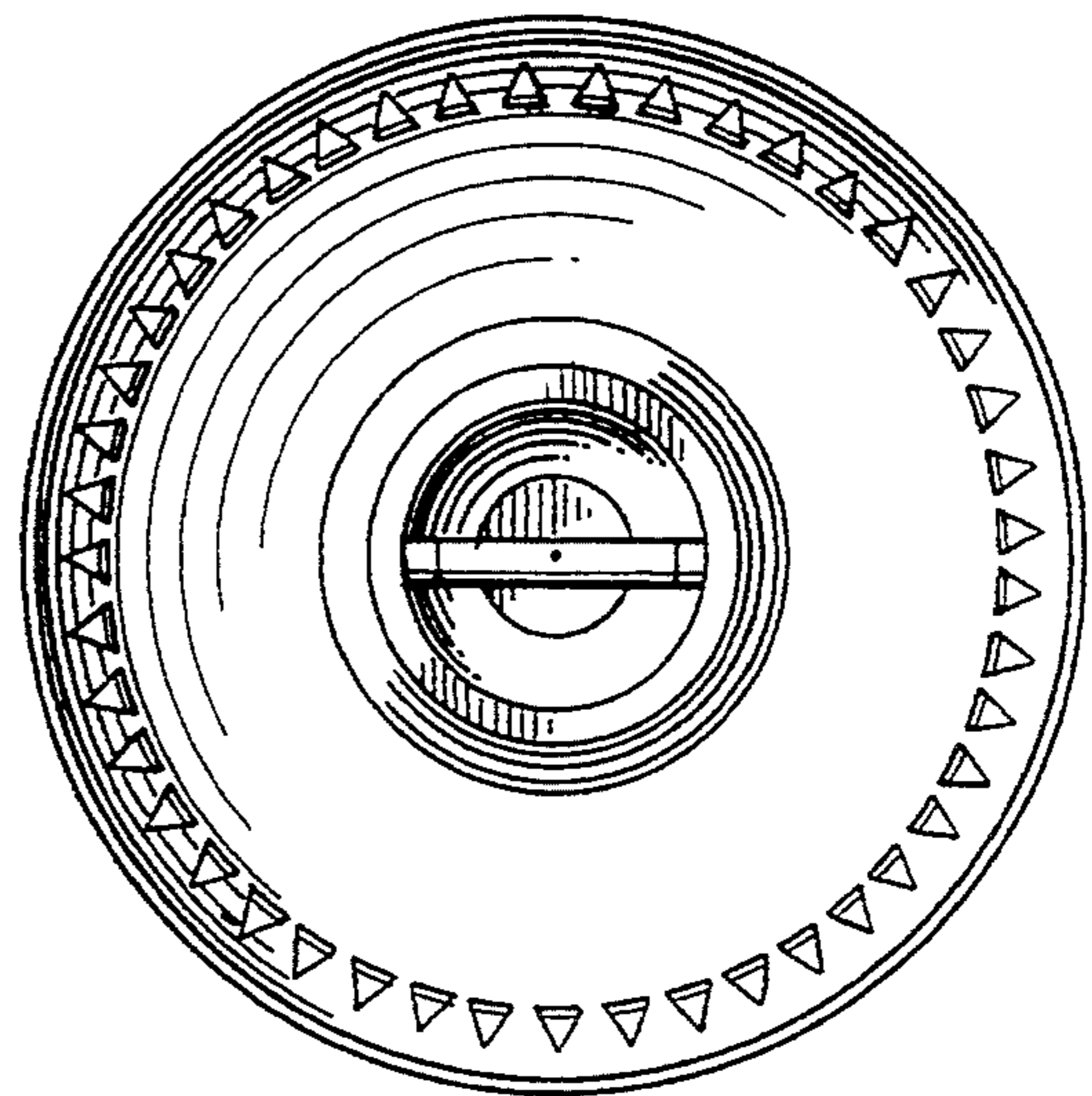

FIG. 14

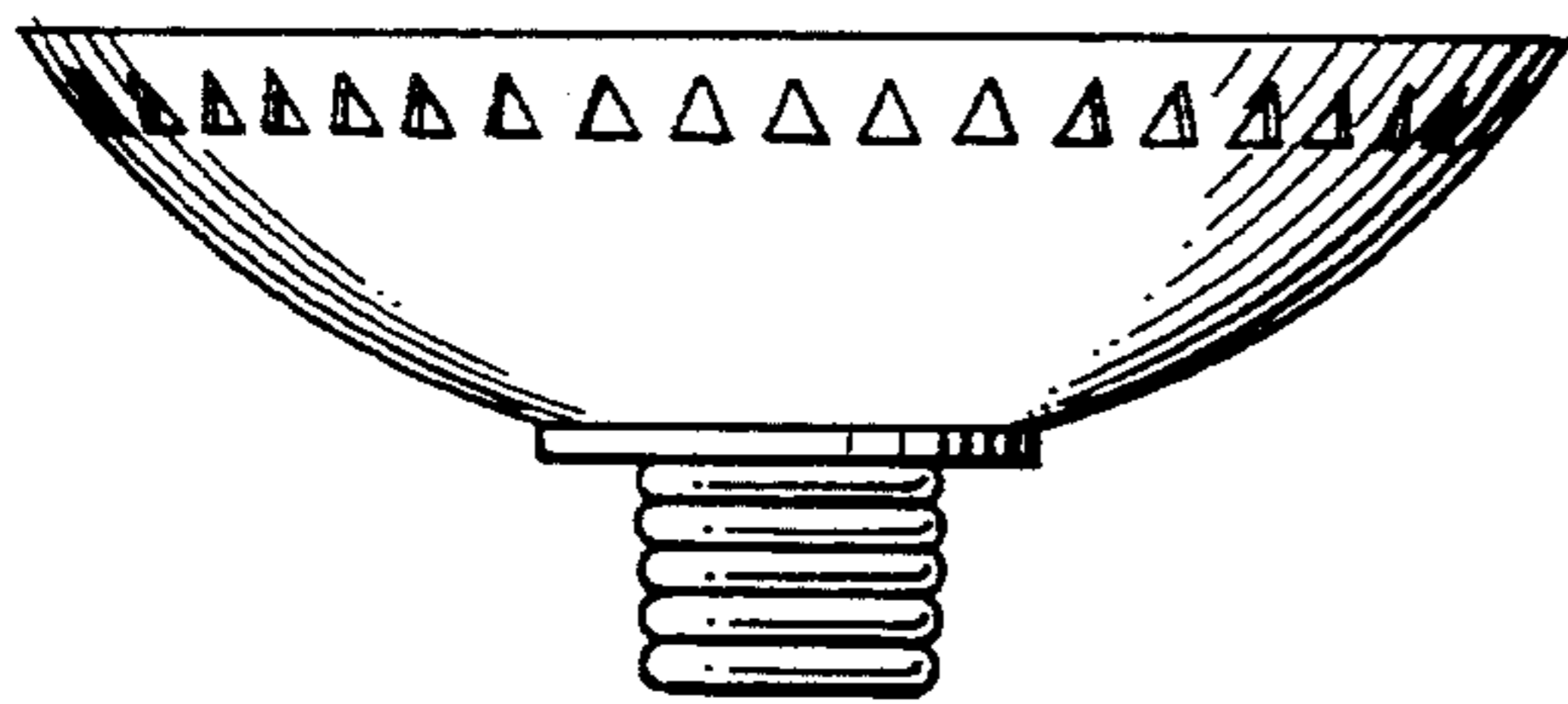

FIG. 15



FIG. 16

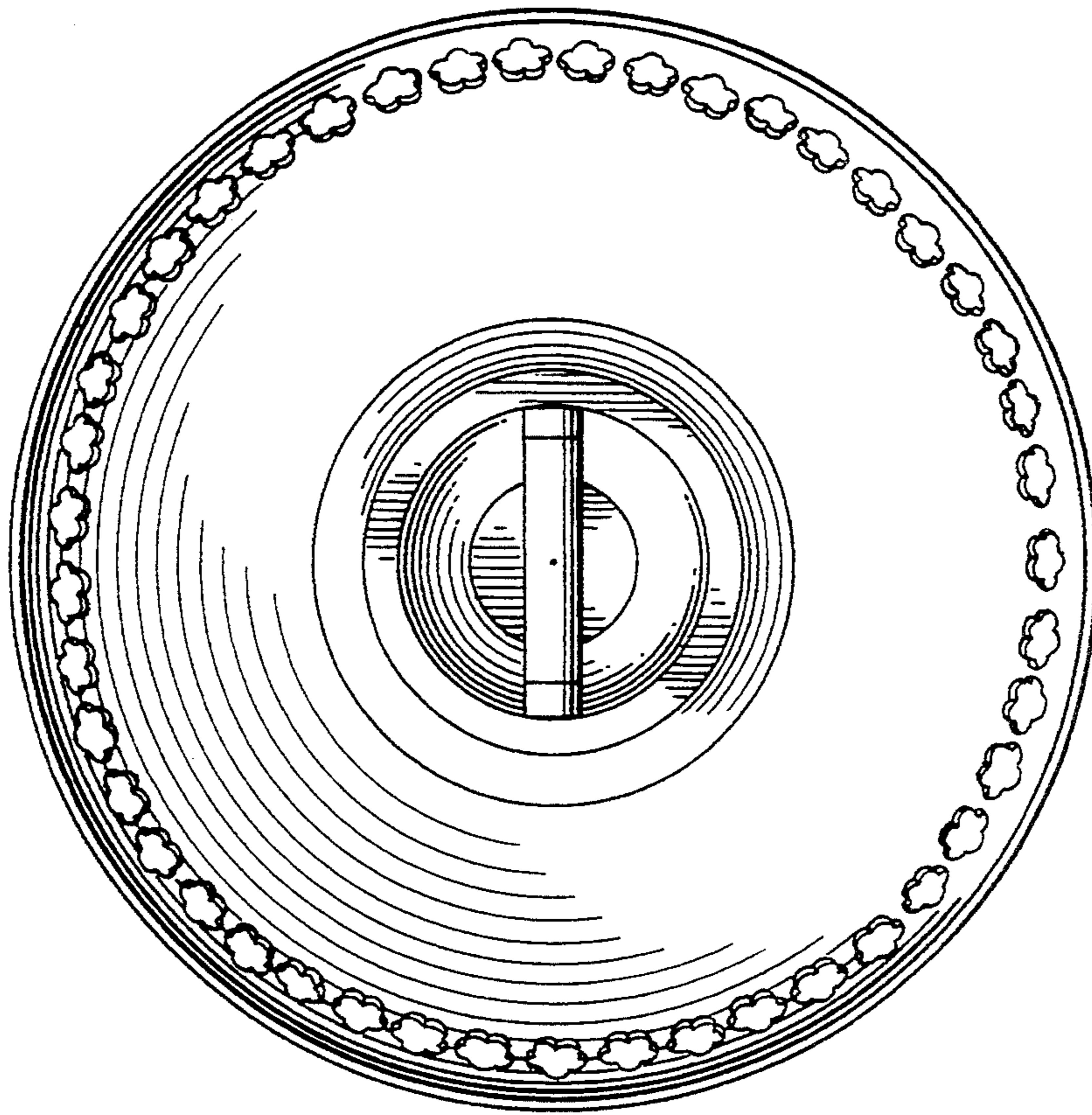

FIG. 18

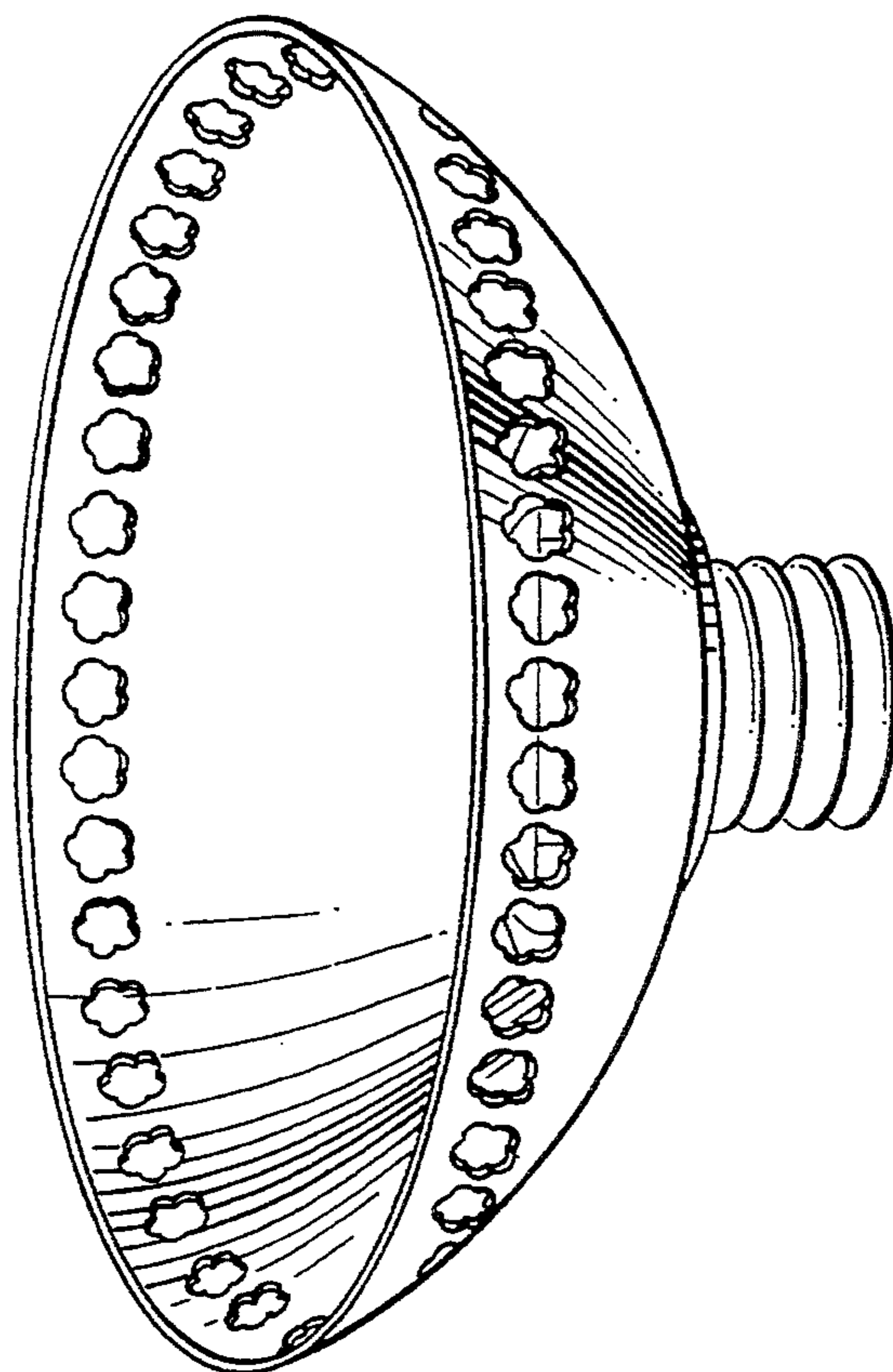

FIG. 17

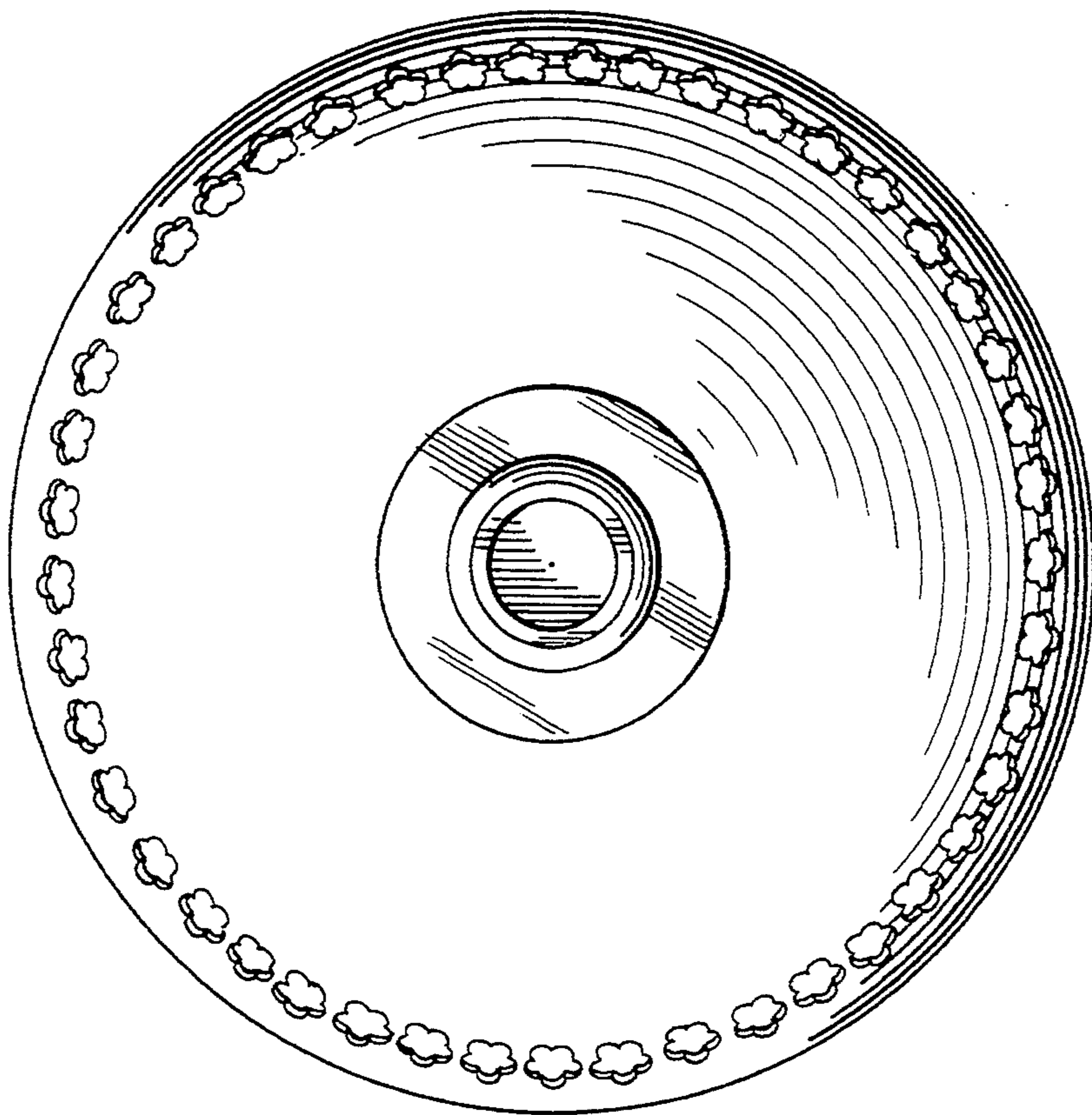

FIG. 20

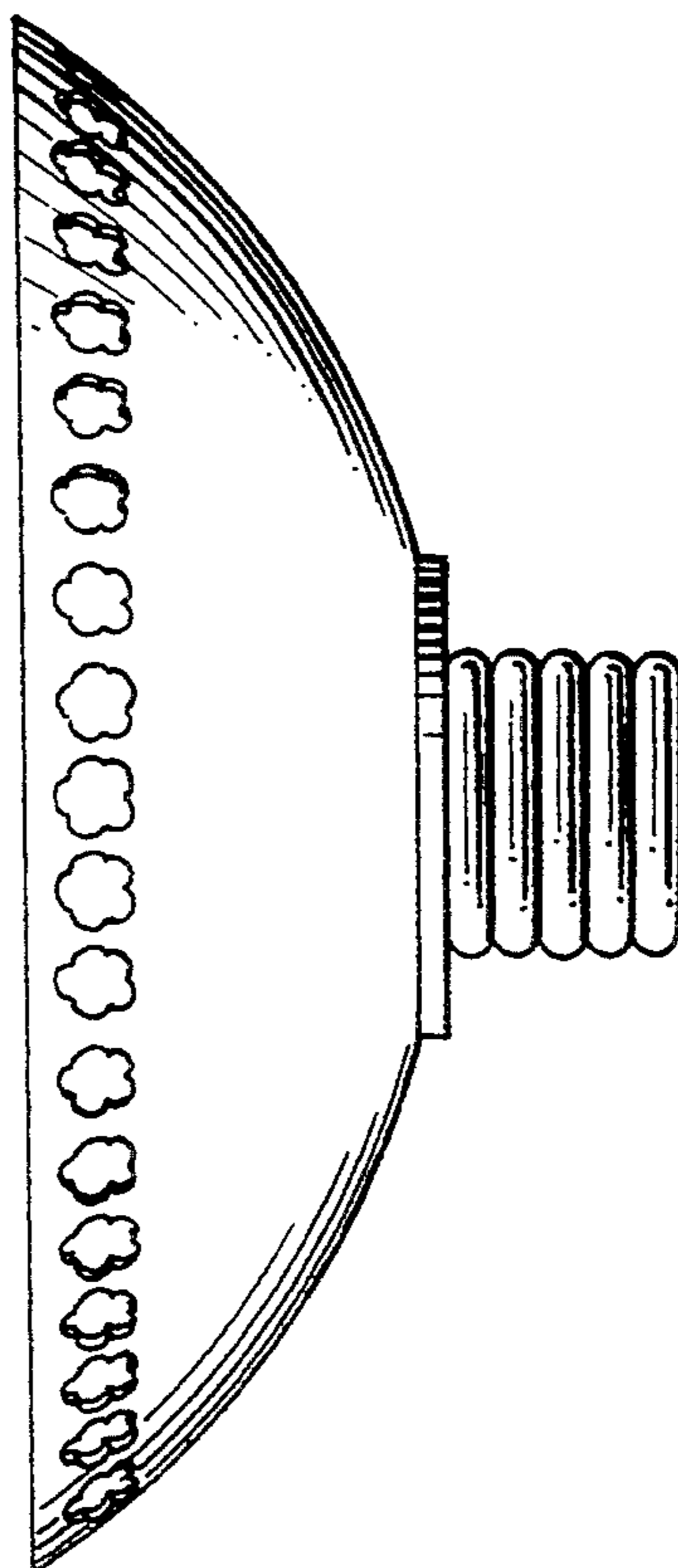

FIG. 19