



US00D360255S

United States Patent [19]

Nagato

[11] Patent Number: Des. 360,255

[45] Date of Patent: ** Jul. 11, 1995

[54] URINAL

[75] Inventor: Kenichi Nagato, Kitakyushu, Japan

[73] Assignee: Toto Ltd., Kitakyushu, Japan

[**] Term: 14 Years

[21] Appl. No.: 25,605

[22] Filed: Jul. 6, 1994

D. 222,062 9/1971 Rutzick D23/302
D. 294,966 3/1988 Kohler, Jr. et al. D23/302

FOREIGN PATENT DOCUMENTS

41102515 11/1965 Japan .

Primary Examiner—A. Hugo Word
Assistant Examiner—Eric M. Watterson
Attorney, Agent, or Firm—Ladas & Parry

Related U.S. Application Data

[63] Continuation of Ser. No. 5,121, Feb. 23, 1993, abandoned.

Foreign Application Priority Data

Aug. 25, 1992 [JP] Japan 4-25063
[52] U.S. Cl. D23/302
[58] Field of Search D23/302, 309, 301, 308,
D23/310, 307

References Cited

U.S. PATENT DOCUMENTS

D. 49,012 5/1916 Crane D23/302

[57] CLAIM

The ornamental design for a urinal, as shown and described.

DESCRIPTION

FIG. 1 is a front view of a urinal embodying my new design;
FIG. 2 is a rear view of a urinal of FIG. 1;
FIG. 3 is a side view of a urinal of FIG. 1;
FIG. 4 is a sectional view of a urinal of FIG. 1 shown in the direction of the arrows of line 4—4 in FIG. 1;
FIG. 5 is a plan view of a urinal of FIG. 1;
FIG. 6 is a bottom view of a urinal of FIG. 1; and,
FIG. 7 is a sectional view of a urinal of FIG. 1 shown in the direction of the arrows of line 7—7 in FIG. 1.

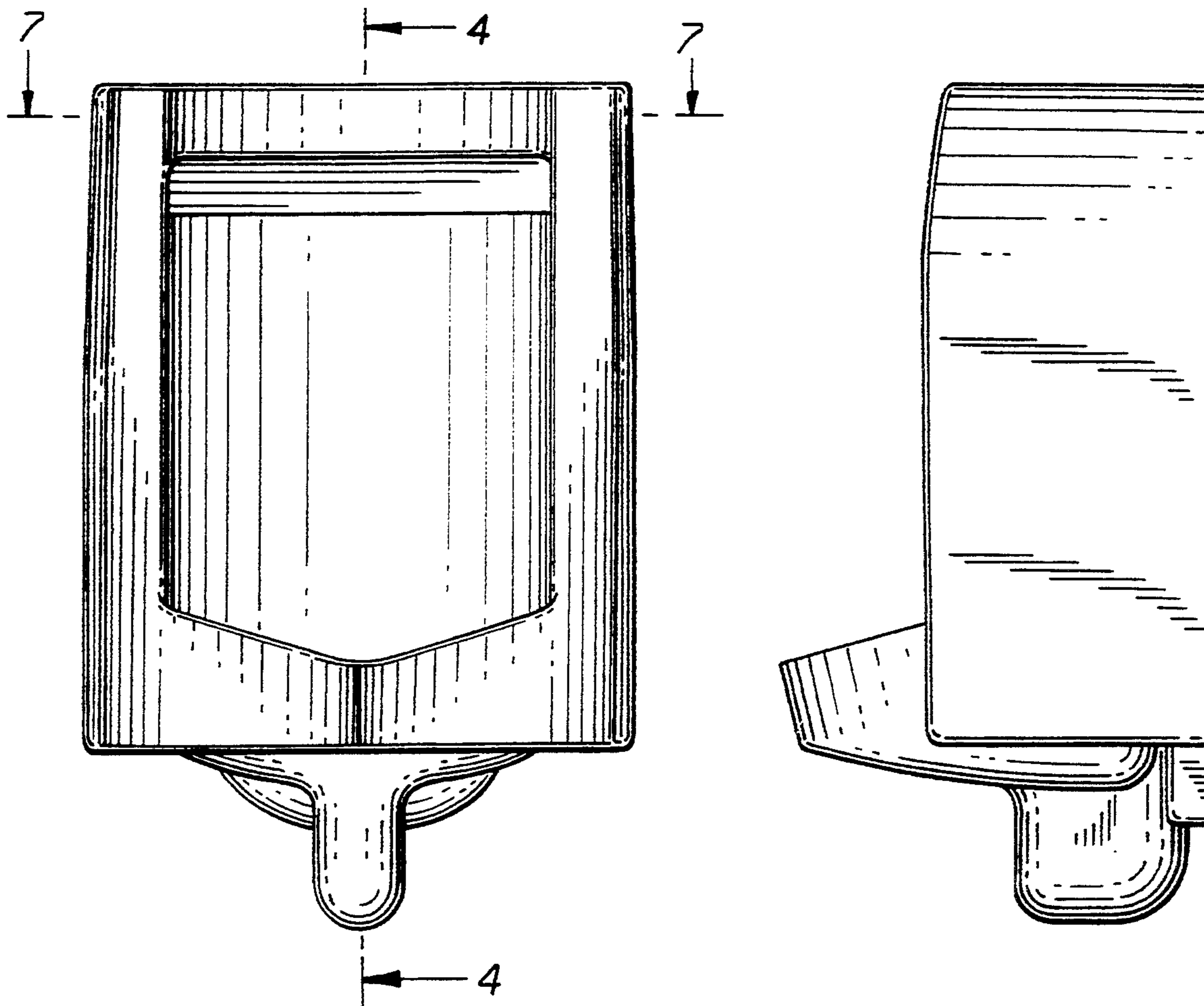

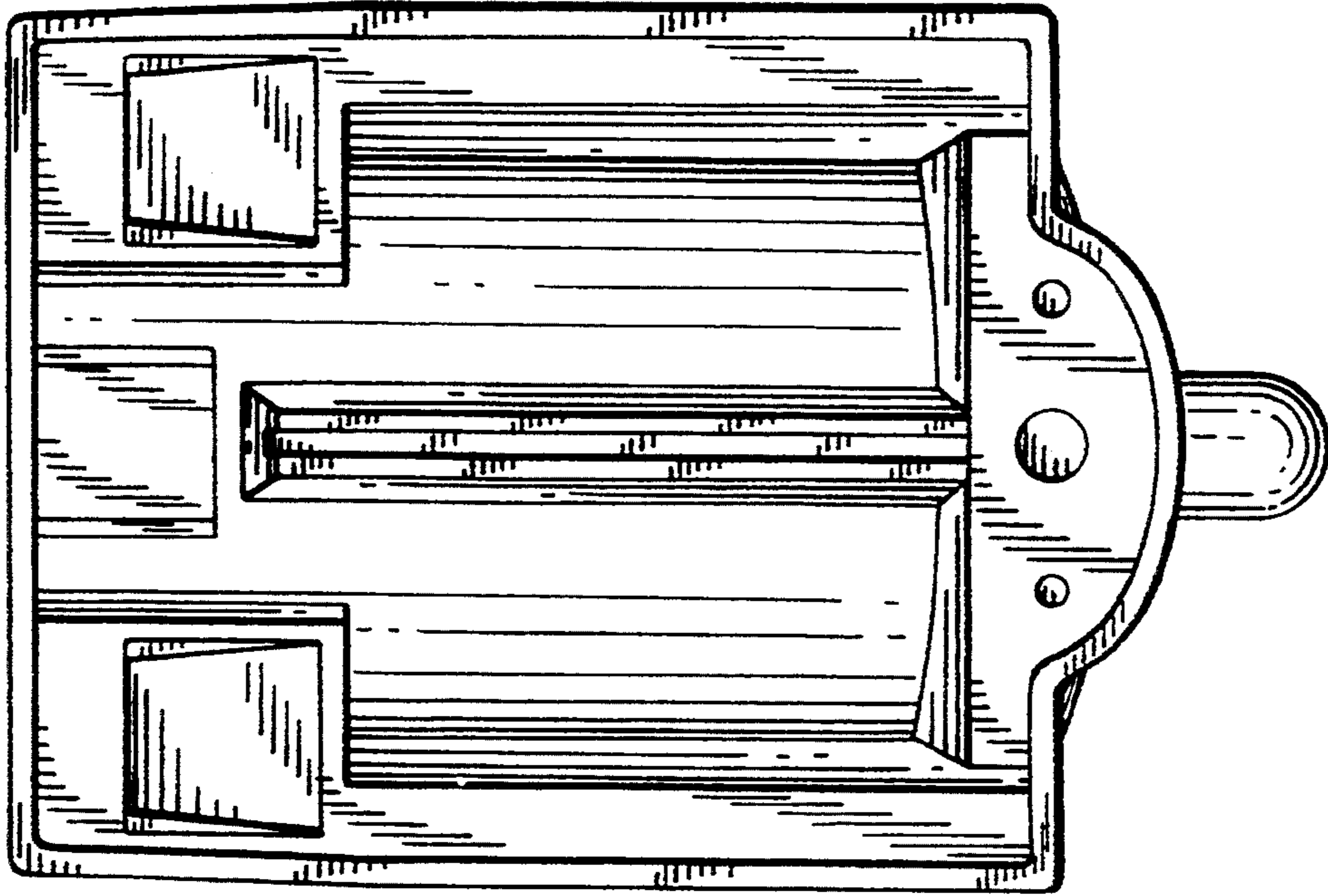

FIG. 2

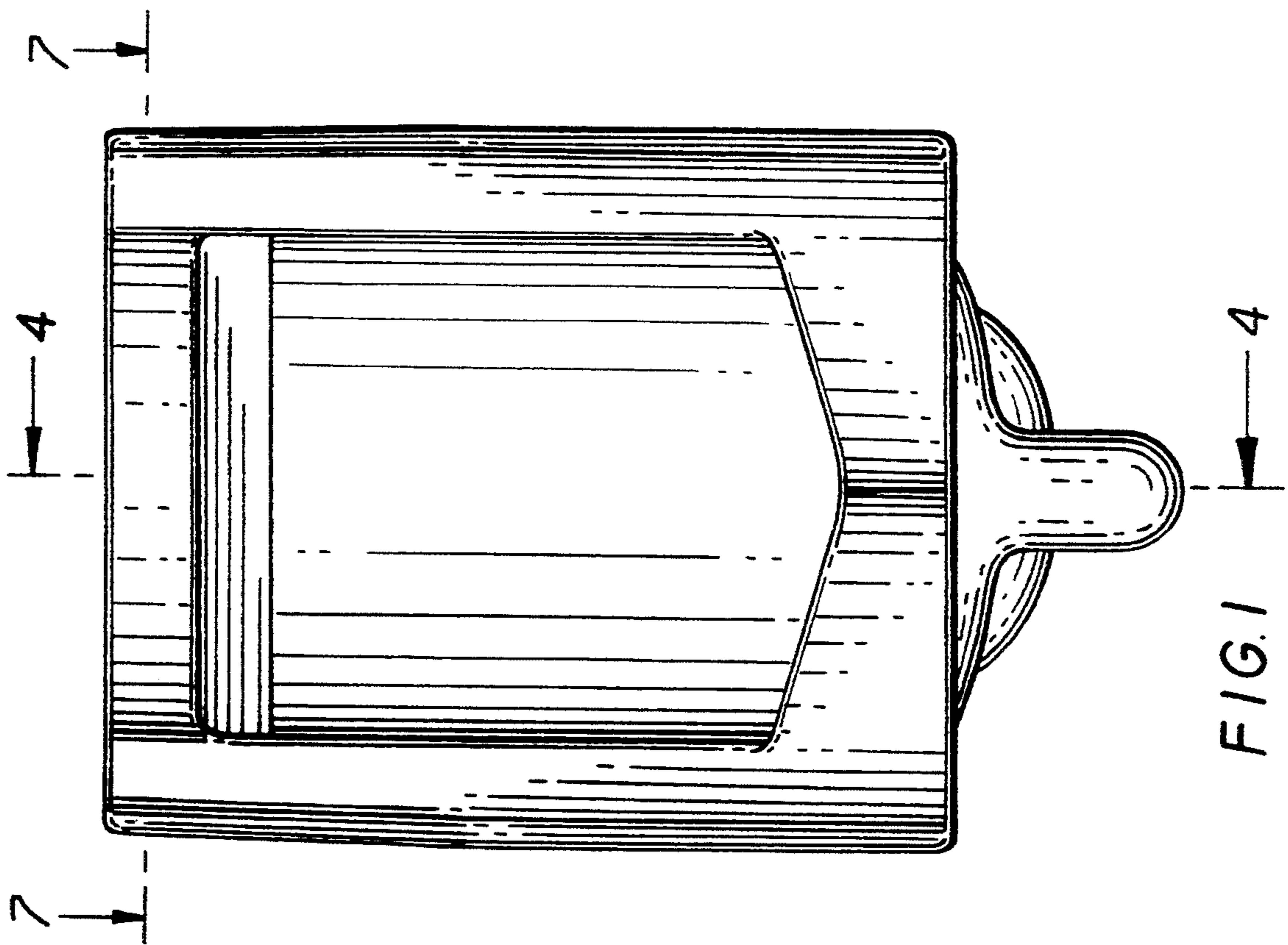

FIG. 1

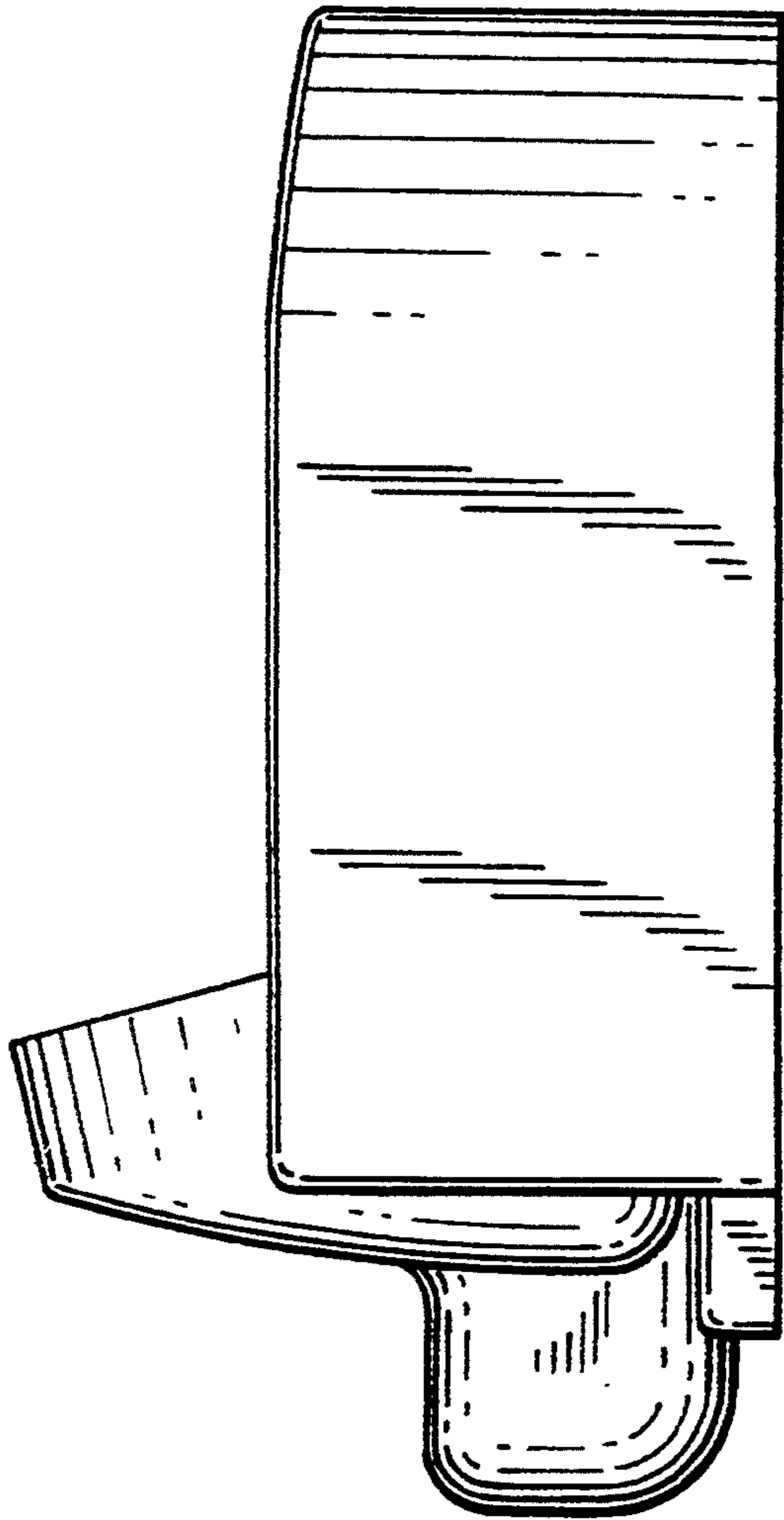

FIG. 3

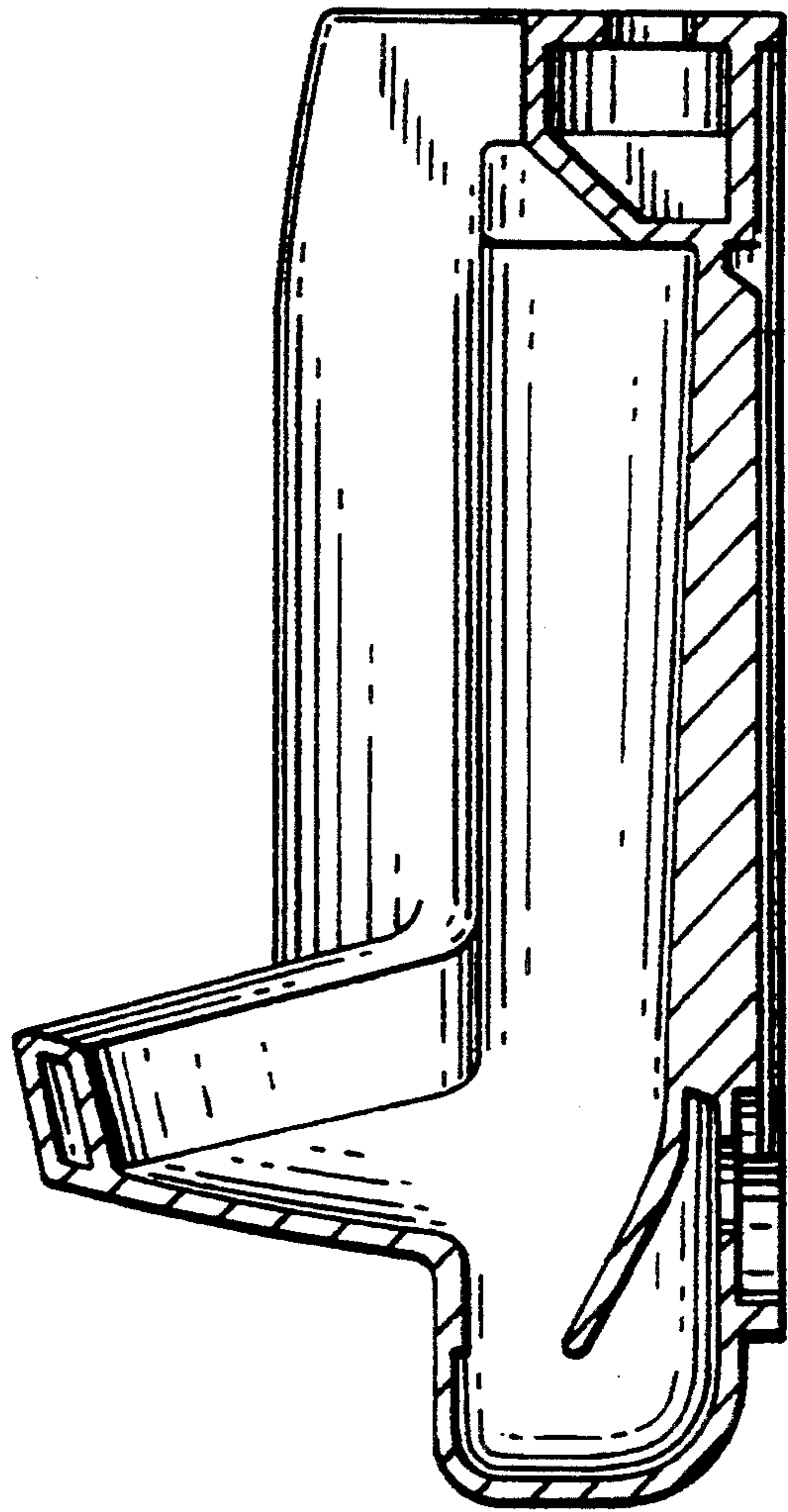

FIG. 4

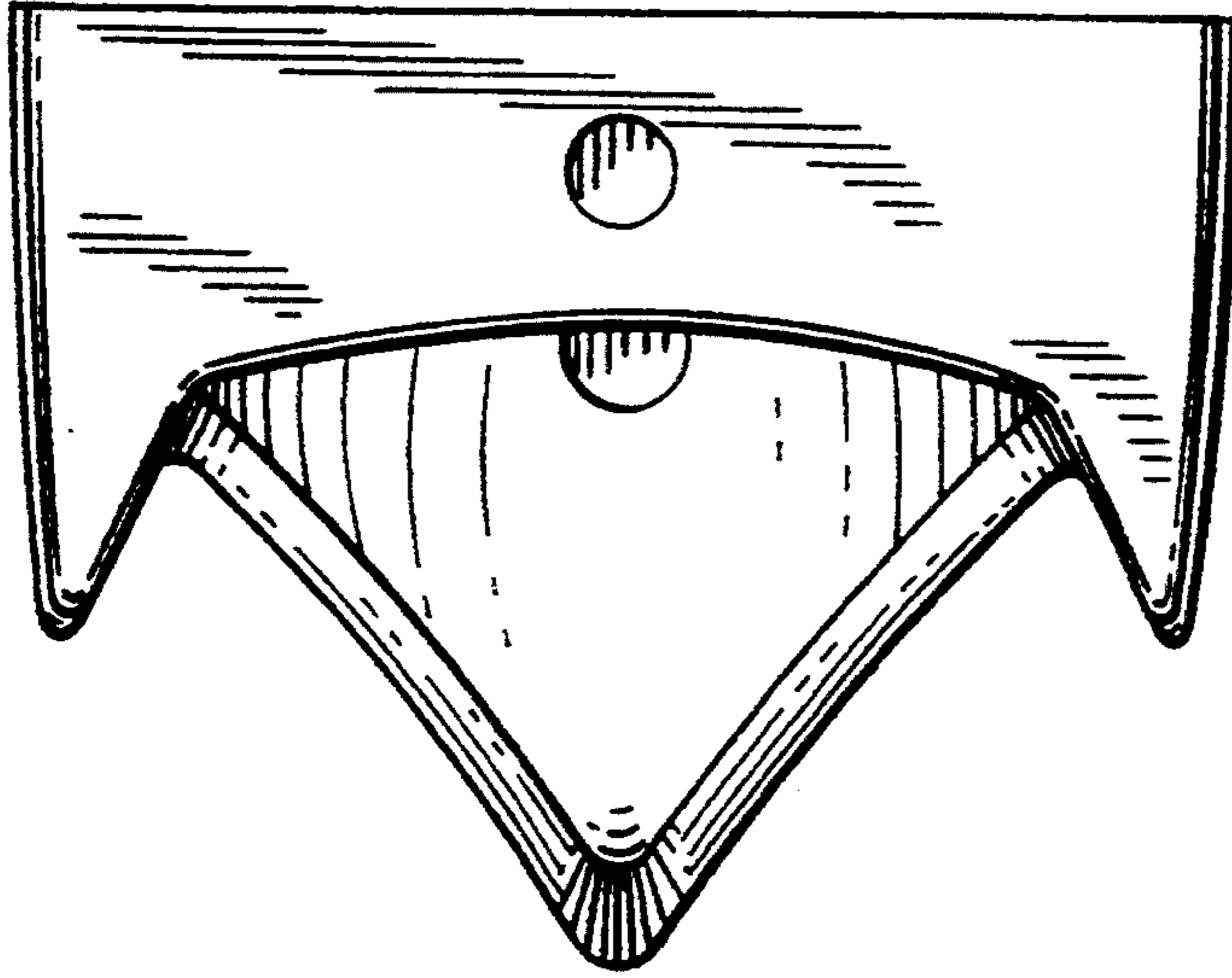

FIG. 5

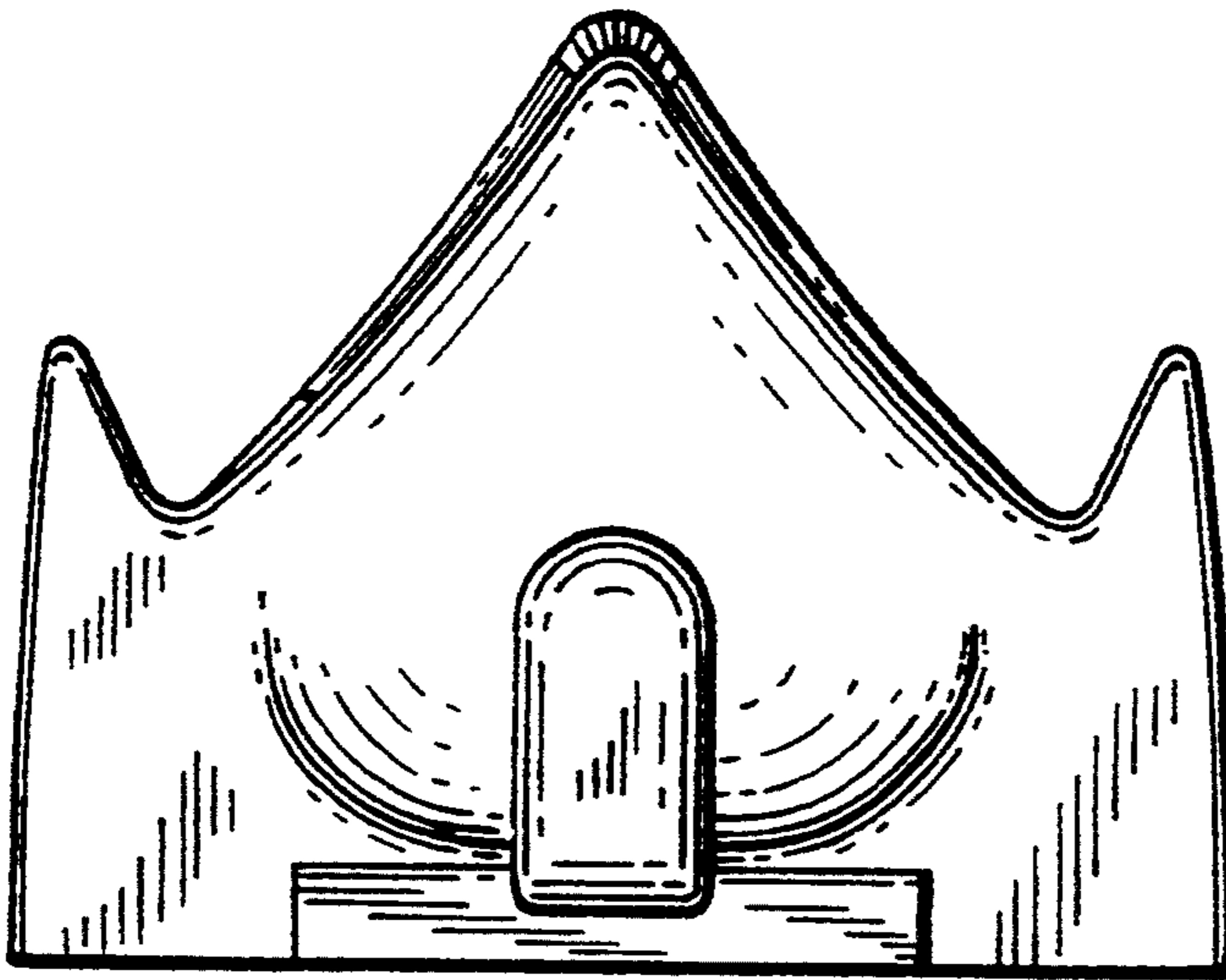

FIG. 6

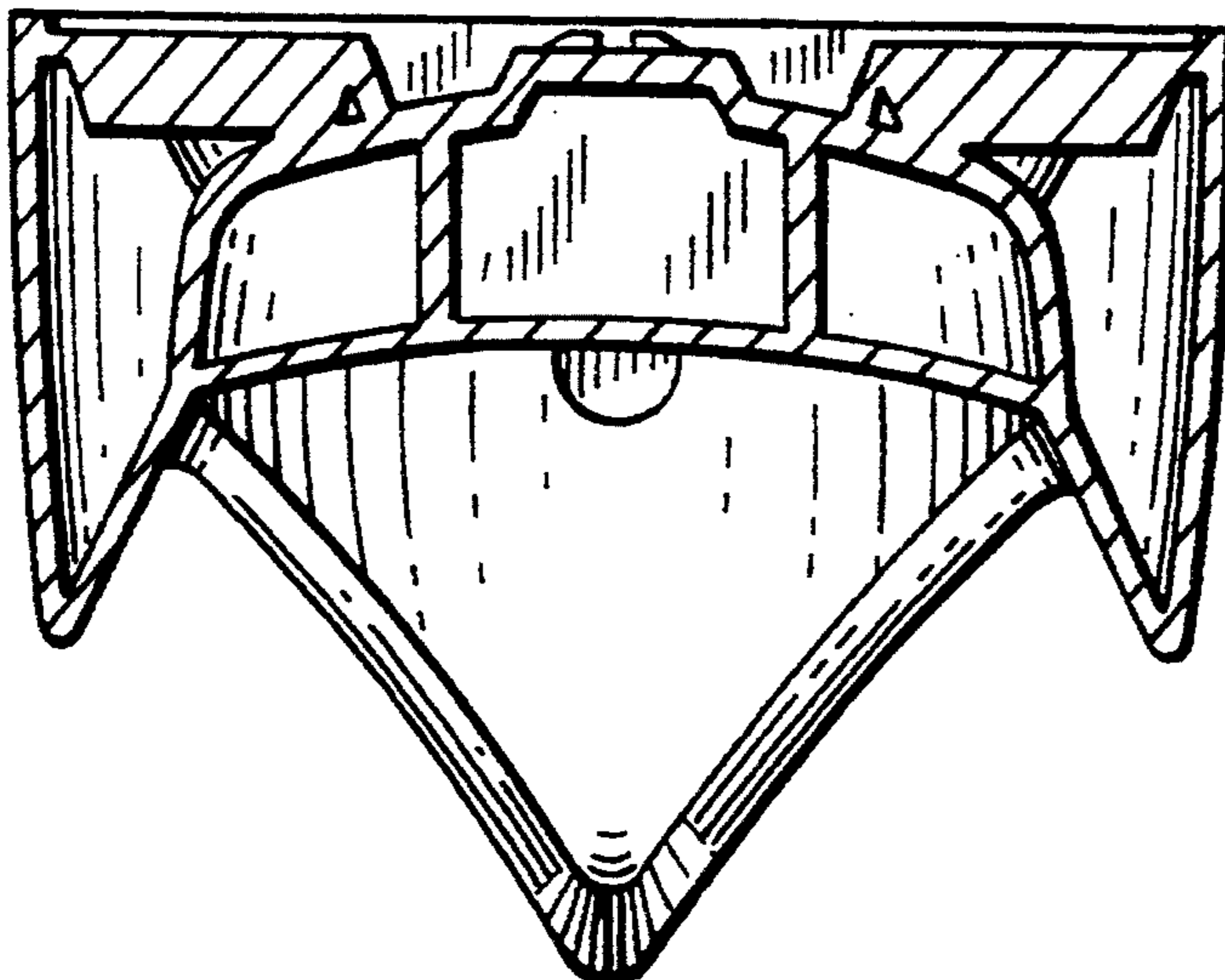

FIG. 7