



US00D360254S

# United States Patent [19]

[11] Patent Number: **Des. 360,254**

**Kohler, Jr. et al.**

[45] Date of Patent: **\*\* Jul. 11, 1995**

[54] LAVATORY

[75] Inventors: **Herbert V. Kohler, Jr., Kohler; Mary J. Reid; William C. McKeone**, both of Sheboygan, all of Wis.

[73] Assignee: **Kohler Co., Kohler, Wis.**

[\*\*] Term: **14 Years**

[21] Appl. No.: **15,122**

[22] Filed: **Nov. 5, 1993**

[52] U.S. Cl. .... **D23/293.1**

[58] Field of Search ..... **D23/284-294, D23/308; 4/619, 625, 637, 638, 661, 635, 636, 639-650**

An undated Simca ad showing a pedestaled lavatory, admitted prior art.

Two undated pages from a Girgio catalog showing Models 1029 and 1029WHI pedestal sinks, admitted prior art.

An undated Gucci and showing edge of a pedestal table, admitted prior art.

*Primary Examiner*—A. Hugo Word

*Assistant Examiner*—Eric Watterson

*Attorney, Agent, or Firm*—Quarles & Brady

## [57] CLAIM

The ornamental design for a lavatory, as shown and described.

## [56] References Cited

### U.S. PATENT DOCUMENTS

- D. 37,256 12/1904 Lloyd .
- D. 37,305 1/1905 Podmore .
- D. 37,519 8/1905 Gavin .
- D. 217,968 7/1970 Armstrong ..... D23/293.1
- D. 260,678 9/1981 Hiller ..... D23/293.1
- D. 288,351 2/1987 Smith ..... D23/285
- D. 295,671 5/1988 Kohler, Jr. .... 23/294
- D. 320,263 9/1991 Kohler, Jr. et al. .... D23/293.1
- 827,278 7/1906 Wilkison .

### OTHER PUBLICATIONS

P. 7A-5 dated Apr. 1988 of a Kohler Co. design data sheet showing a Model K-6825 lavatory leg.  
Undated Kohler Co. ad showing a free standing bathtub with a curvilinear towel bar, admitted prior art.

## DESCRIPTION

FIG. 1 is a perspective view taken from the top, front and left side of a lavatory embodying our new design;

FIG. 2 is a top plan view thereof;

FIG. 3 is a front elevational view thereof;

FIG. 4 is a right side elevational view thereof, the left side being the mirror image of the right side;

FIG. 5 is a rear elevational view thereof;

FIG. 6 is a cross-sectional view taken on line 6-6 of FIG. 2;

FIG. 7 is a cross-sectional view taken on line 7-7 of FIG. 2; and,

FIG. 8 is a bottom plan view of the embodiment of FIG. 1.

The fragmentary broken line representations of mounting holes in FIGS. 1 and 2 are for the purpose of illustration only and form no part of the claimed design.

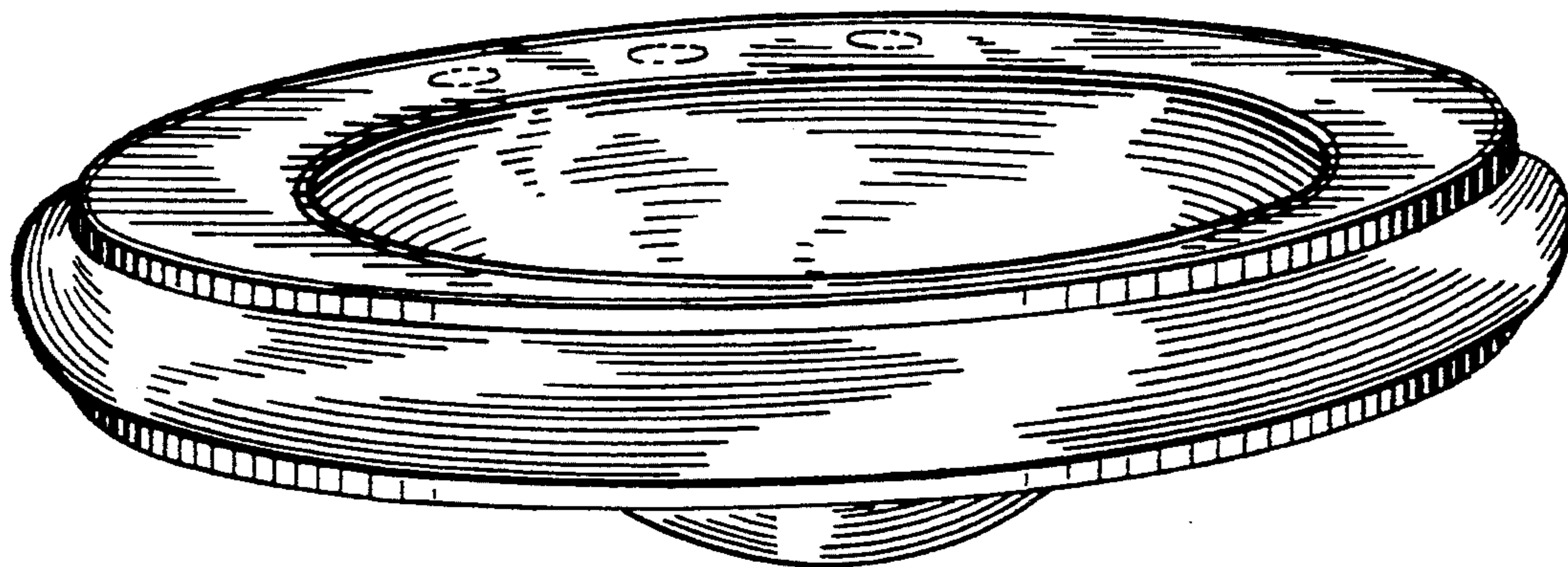

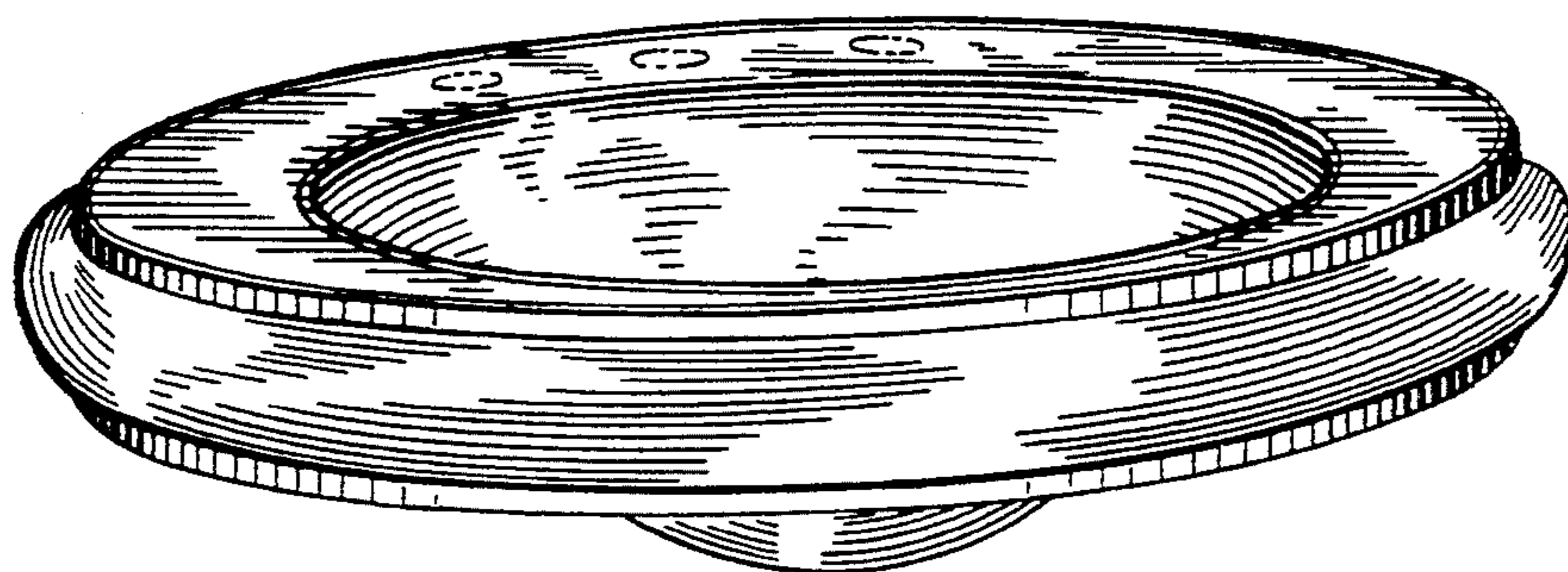

FIG. 1

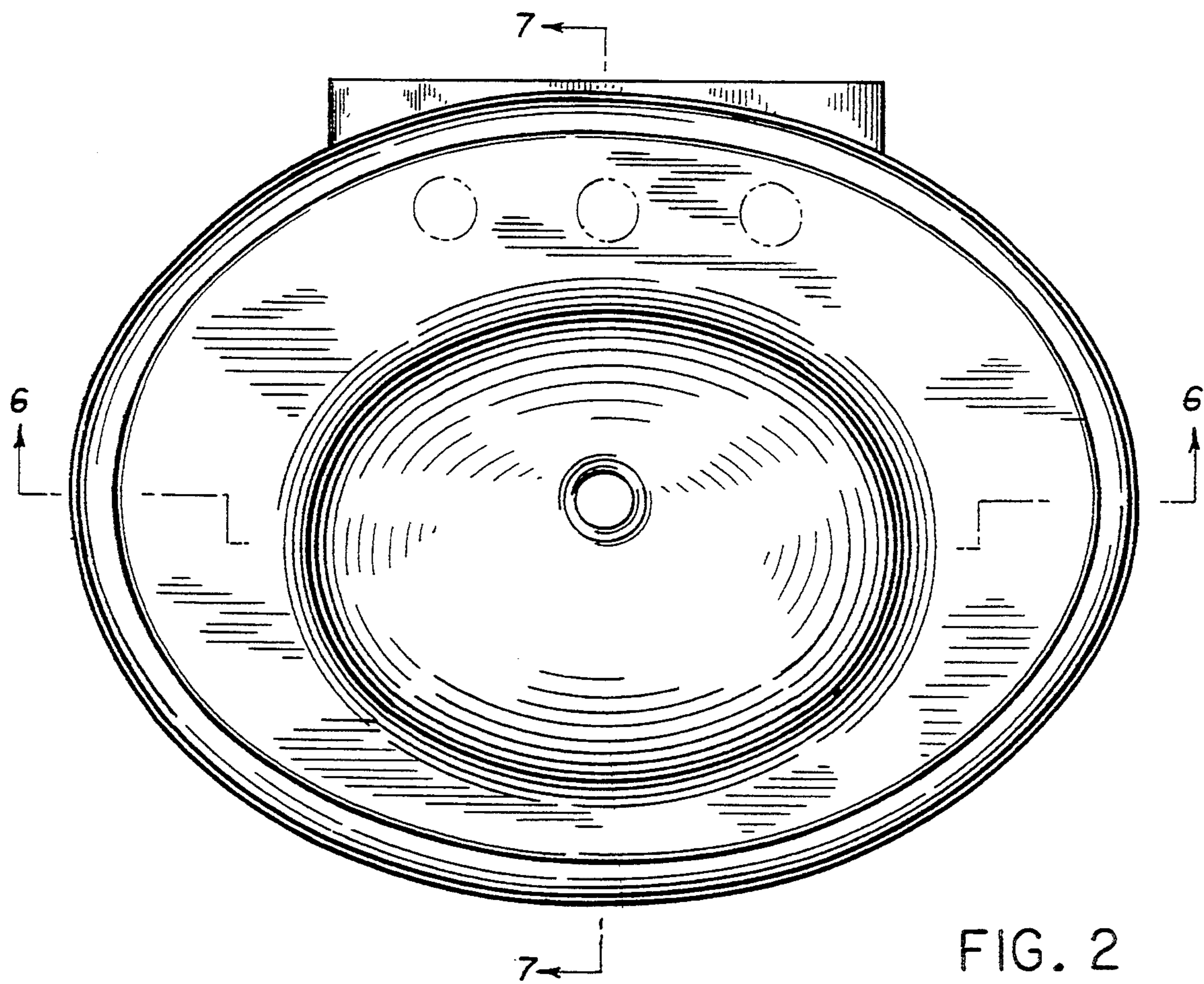

FIG. 2

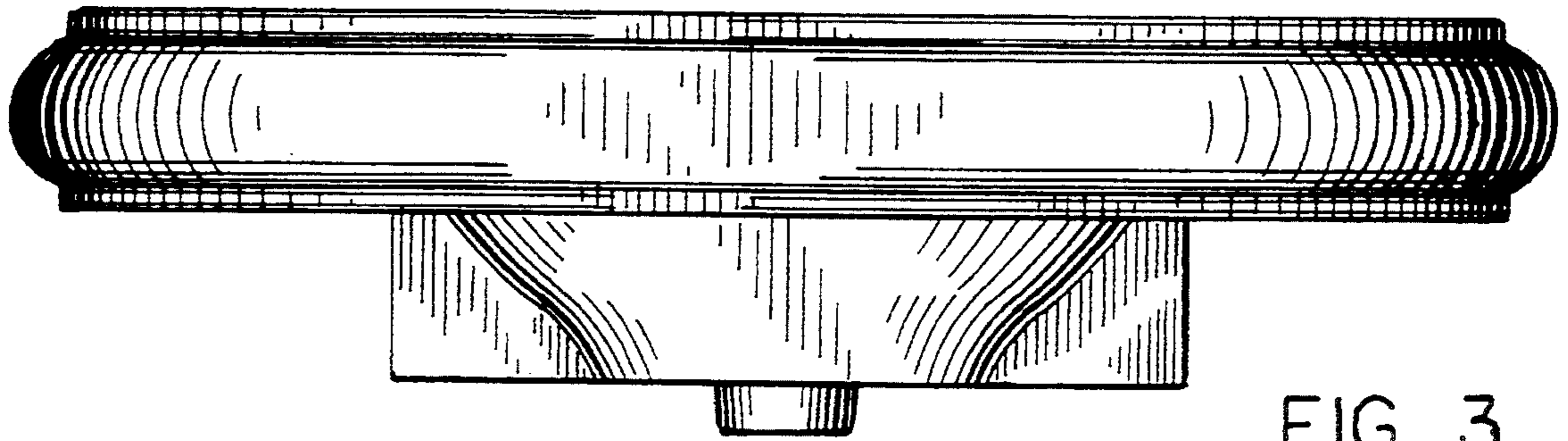

FIG. 3

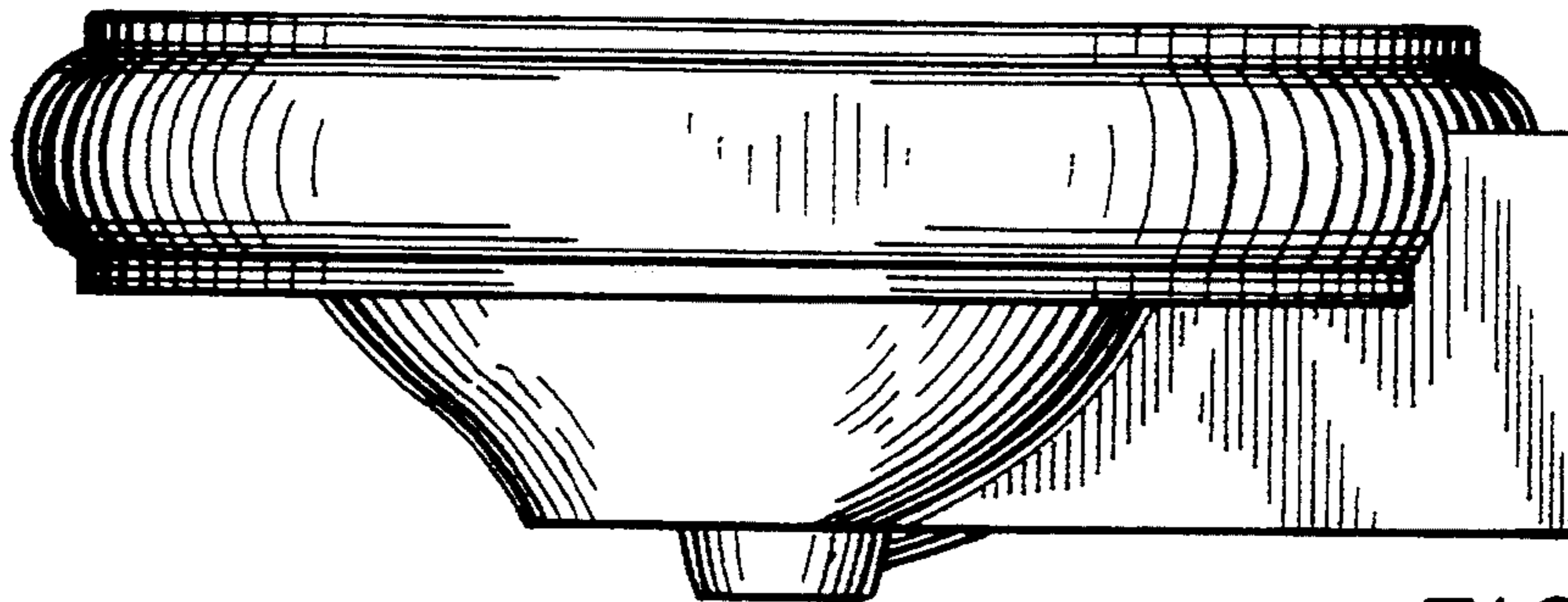

FIG. 4

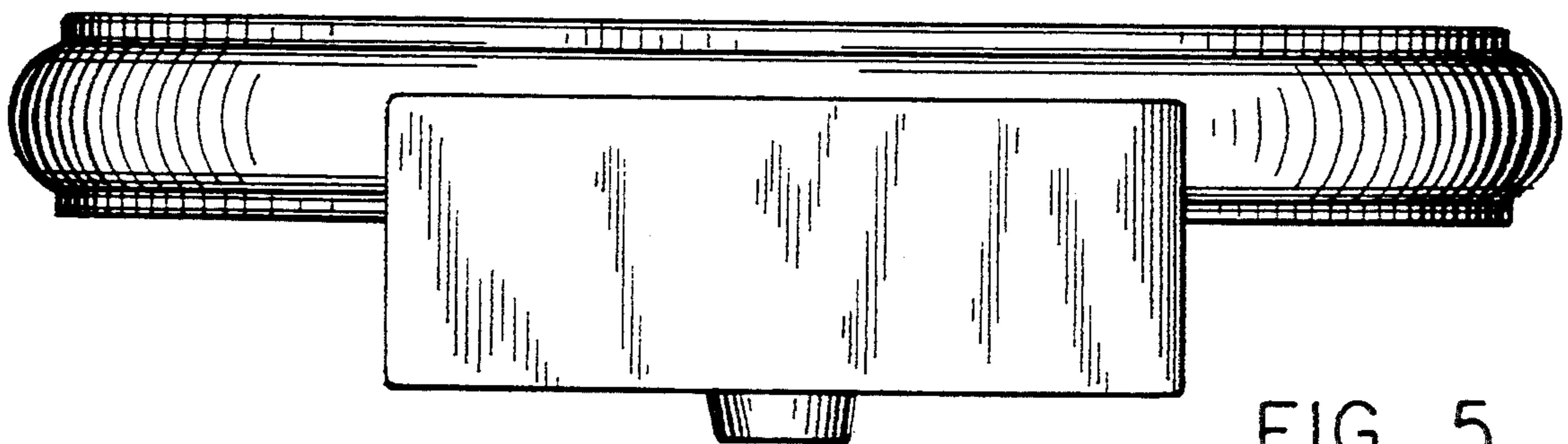

FIG. 5

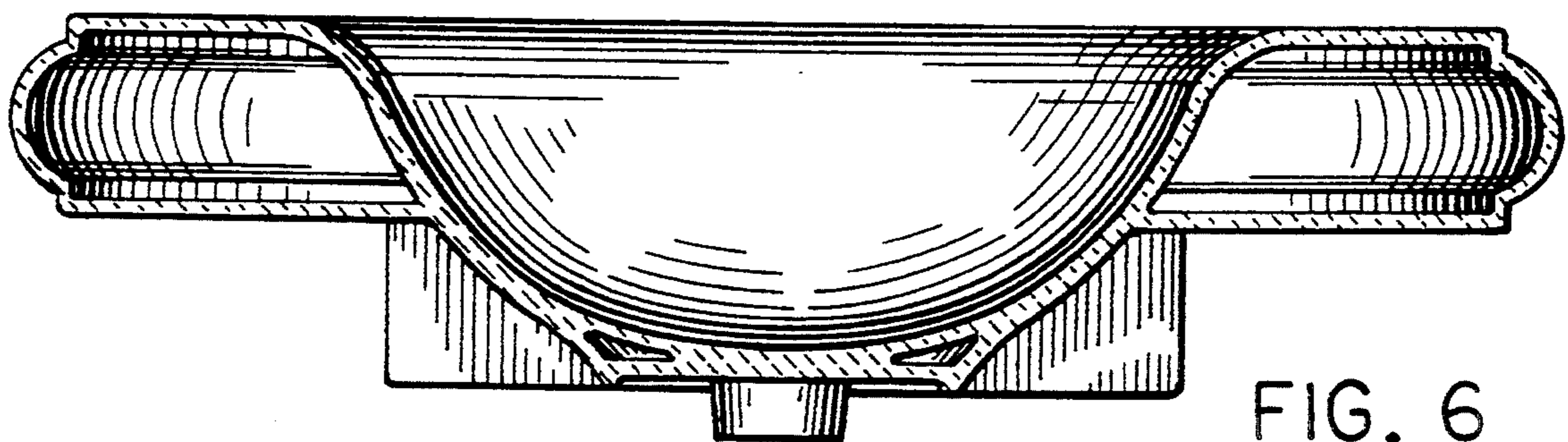

FIG. 6

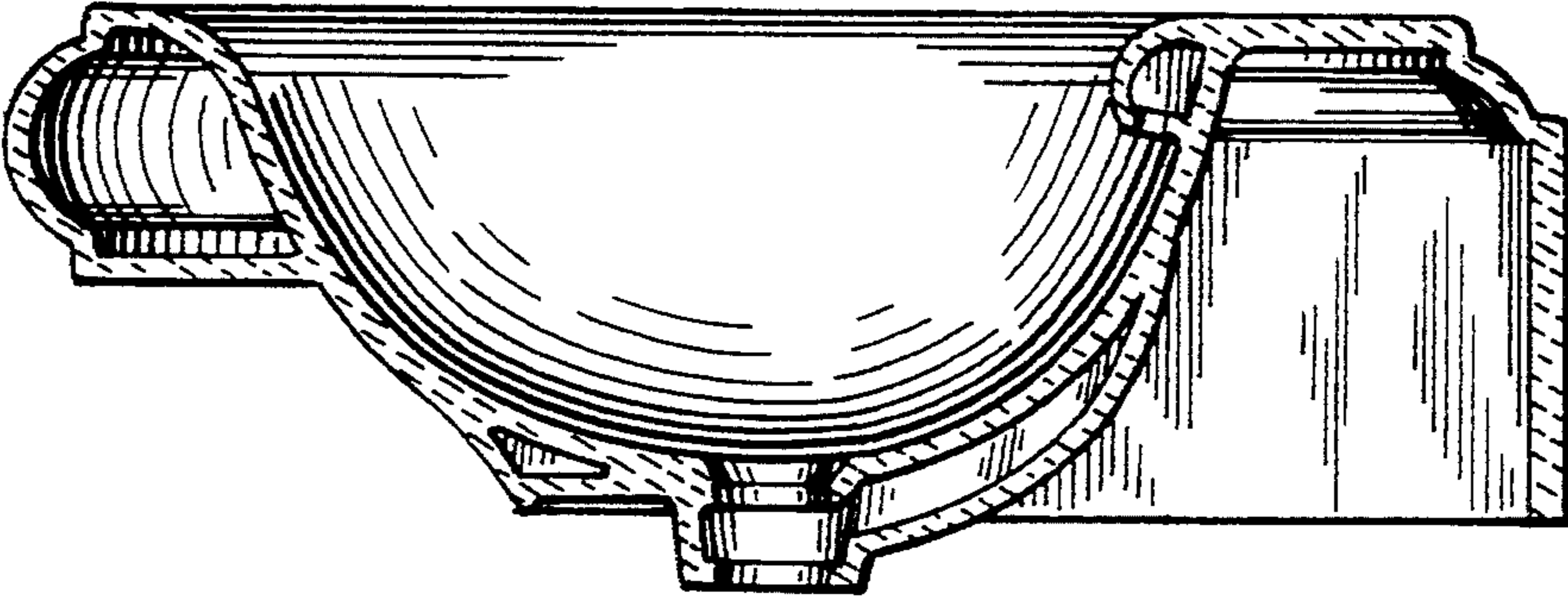

FIG. 7

FIG. 8

