



US00D360218S

United States Patent [19]

Igarashi et al.

[11] Patent Number: **Des. 360,218**

[45] Date of Patent: **** Jul. 11, 1995**

[54] CAMERA

[75] Inventors: **Shigeto Igarashi**, Tokyo; **Minoru Tanabe**, Kawasaki, both of Japan

[73] Assignee: **Canon Kabushiki Kaisha**, Tokyo, Japan

[**] Term: **14 Years**

[21] Appl. No.: **26,839**

[22] Filed: **Aug. 8, 1994**

[30] Foreign Application Priority Data

Feb. 9, 1994 [JP] Japan 6-2848

[52] U.S. Cl. **D16/209**; D16/218

[58] Field of Search D16/200-204,
D16/208, 209, 216-218; 354/126, 149.11, 202,
288

[56] References Cited

U.S. PATENT DOCUMENTS

- D. 324,541 12/1993 McBride et al. D16/209
- D. 335,680 5/1993 Onuma D16/209
- D. 337,342 7/1993 Horikiri D16/209

- D. 339,367 9/1993 Yamamoto D16/217
- D. 340,736 10/1993 Leung D16/218
- D. 342,963 1/1994 Isozaki D16/209
- 5,255,032 10/1993 Michaud 354/149.11

OTHER PUBLICATIONS

Skin Diver, Jan. 1988 p. 9 (Nikon's Nikonos-V).

Primary Examiner—Theodore M. Shooman

Assistant Examiner—Adir Aronovich

Attorney, Agent, or Firm—Fitzpatrick, Cella, Harper & Scinto

[57] CLAIM

The ornamental design for a camera, as shown and described.

DESCRIPTION

FIG. 1 is a front elevational view of a camera showing our new design;

FIG. 2 is a rear elevational view thereof;

FIG. 3 is a top plan view thereof;

FIG. 4 is a bottom plan view thereof;

FIG. 5 is a left side elevational view thereof;

FIG. 6 is a right side elevational view thereof; and,

FIG. 7 is a perspective view thereof.

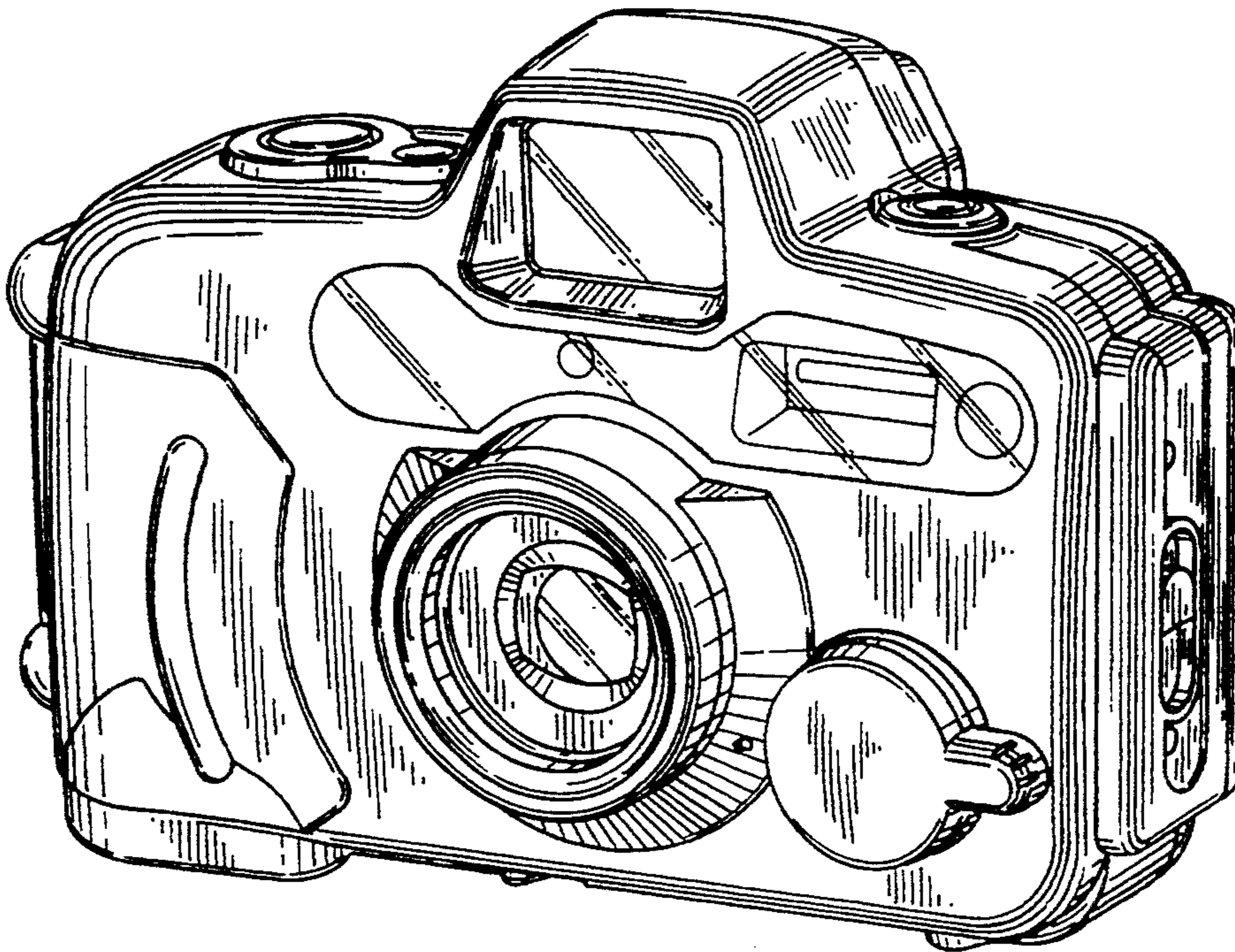

FIG. 1

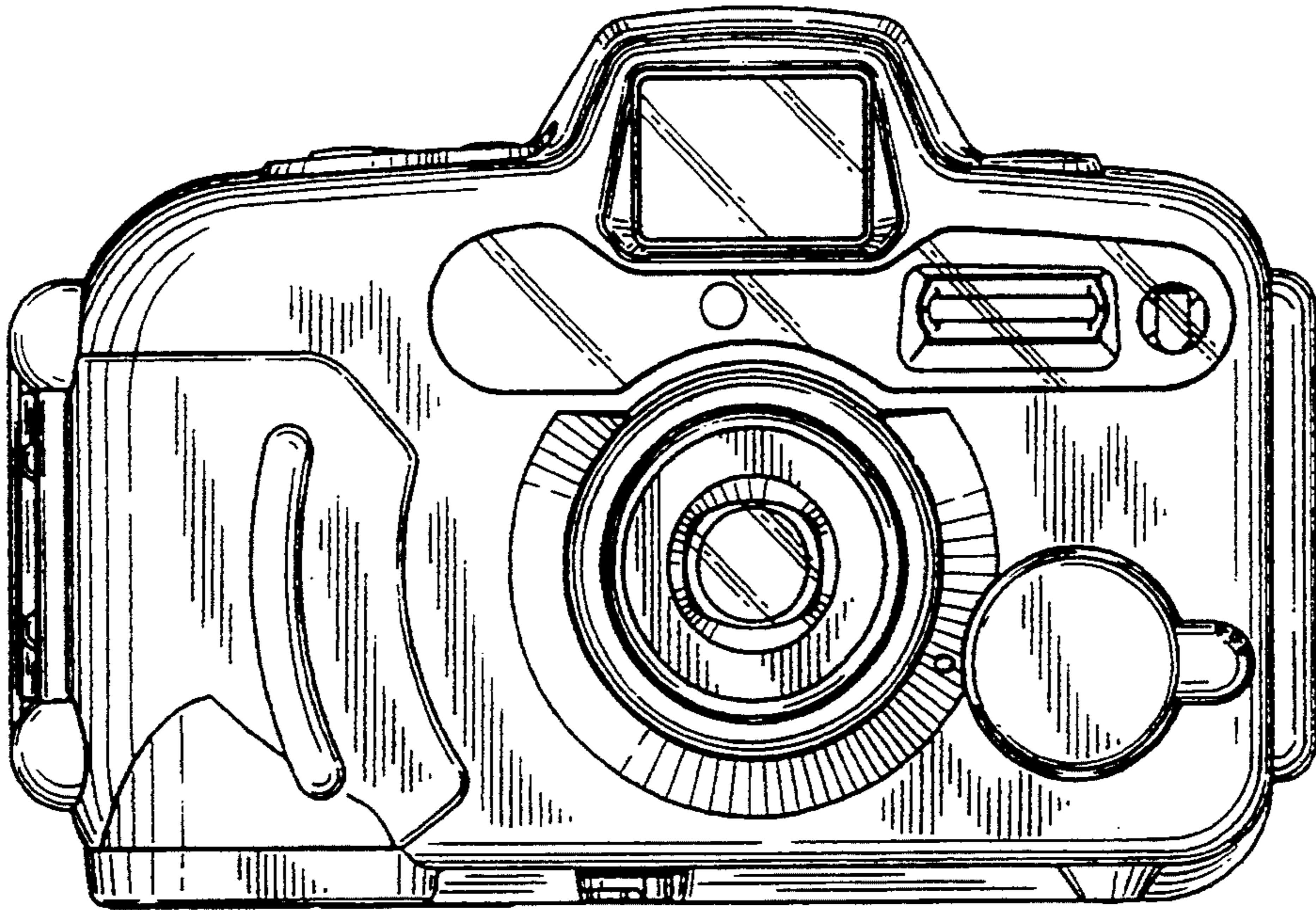

FIG. 2

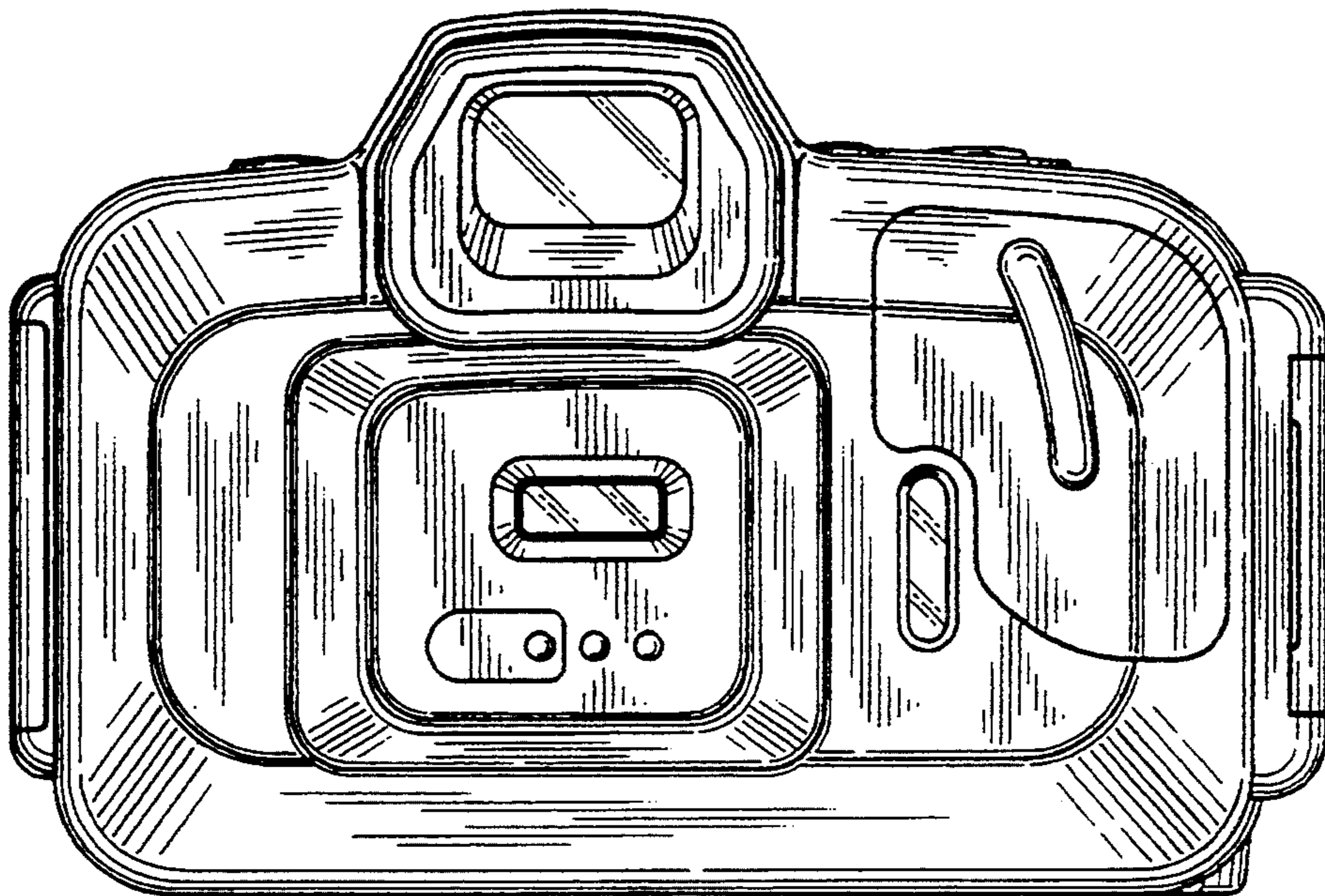

FIG. 3

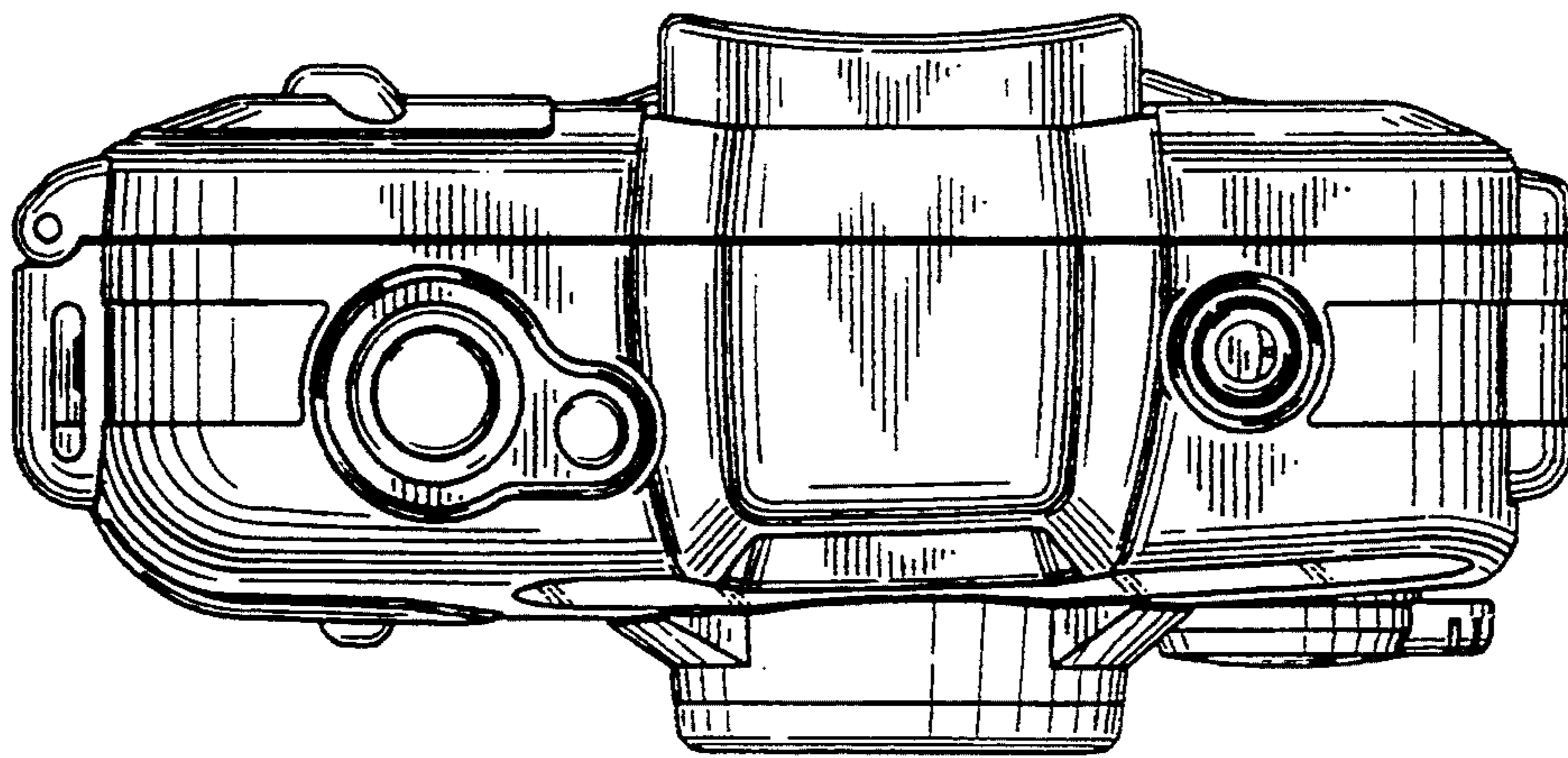

FIG. 4

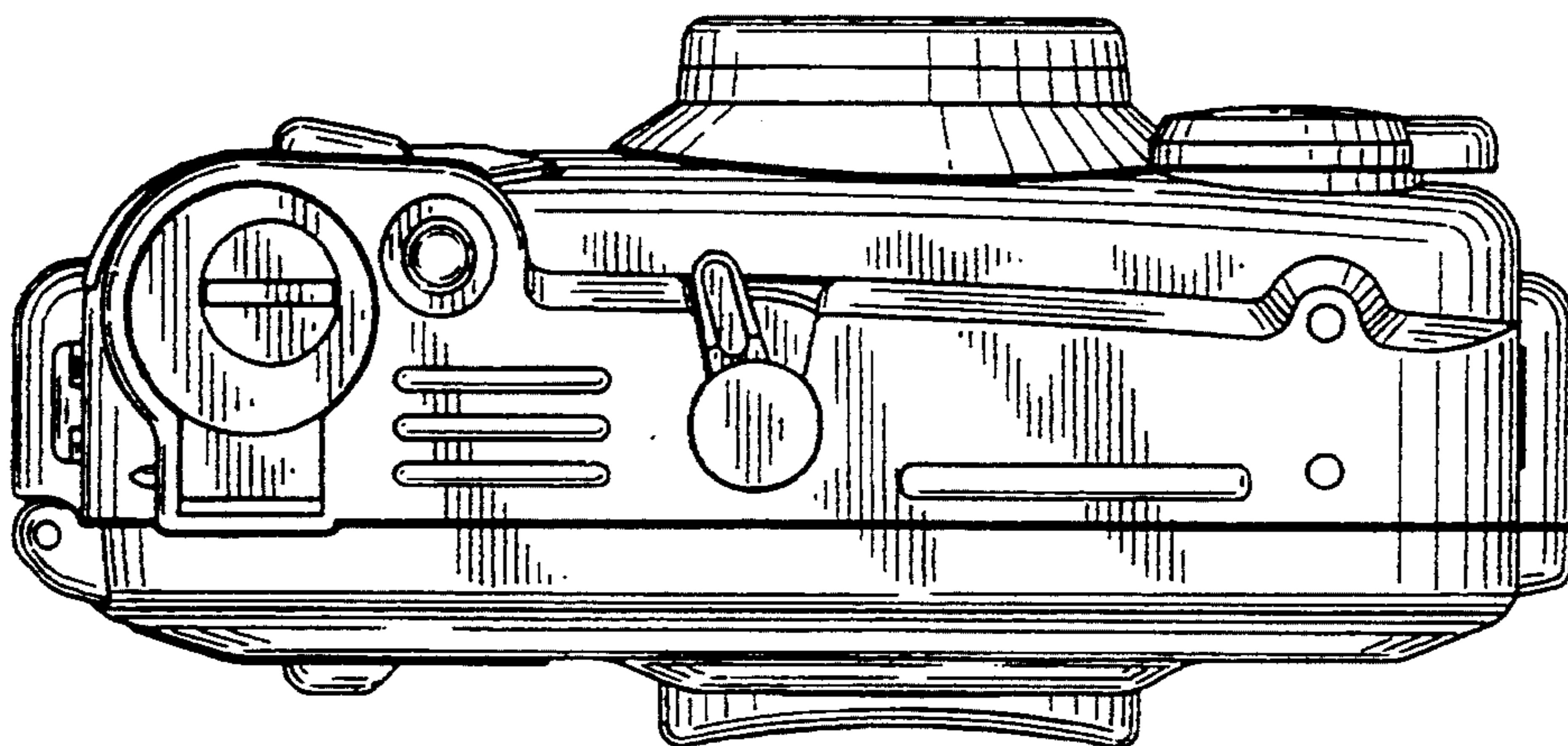

FIG. 5

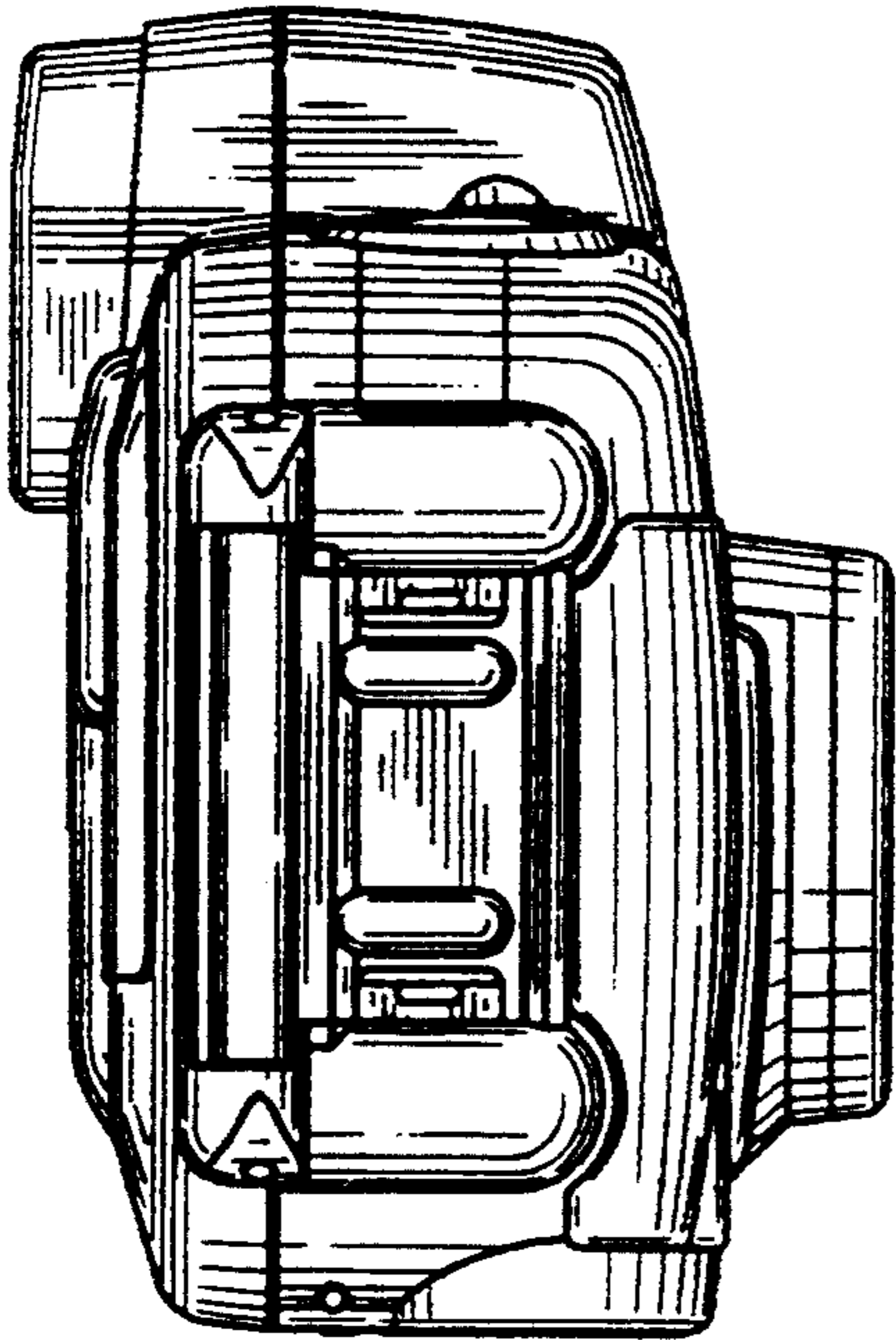

FIG. 6

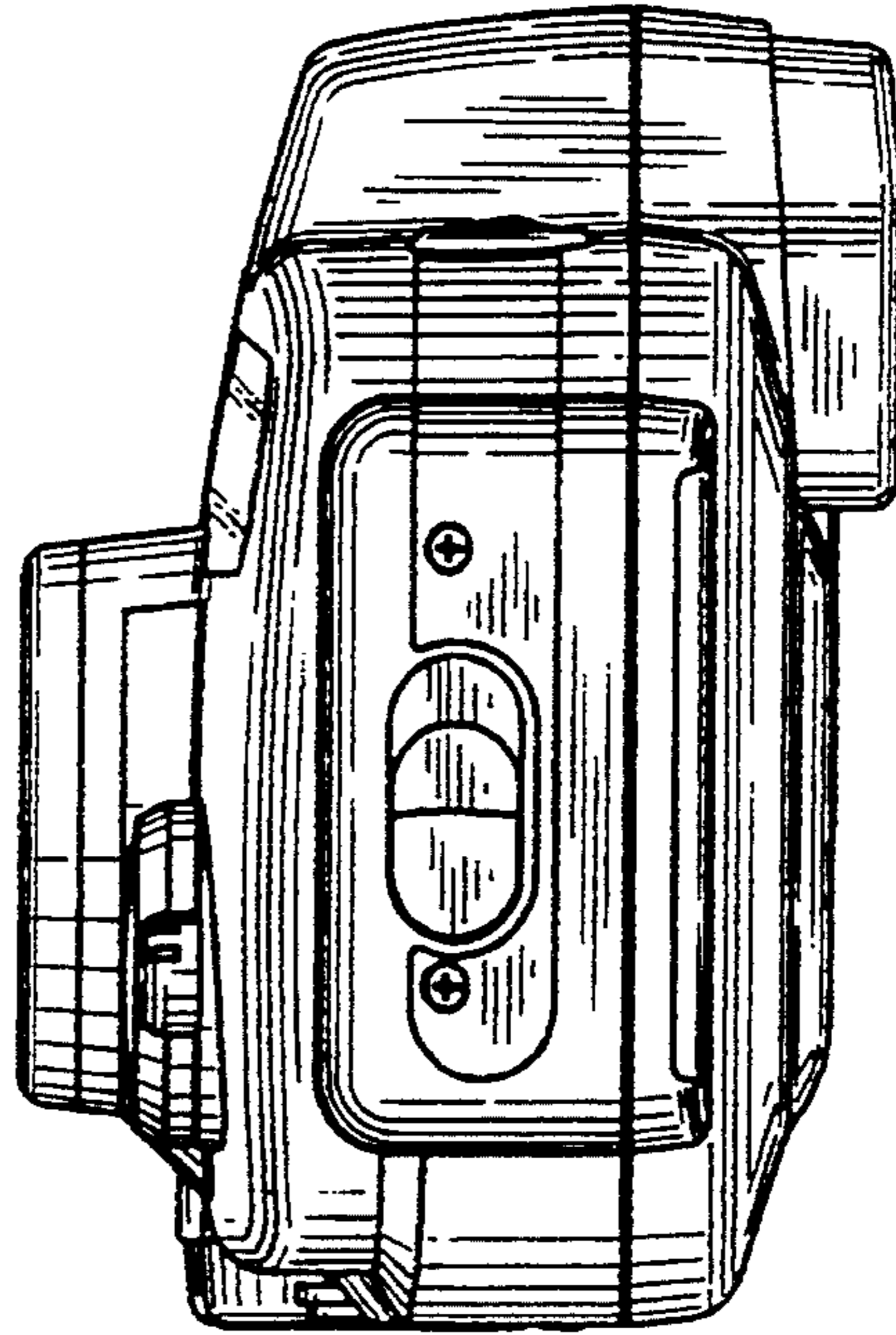
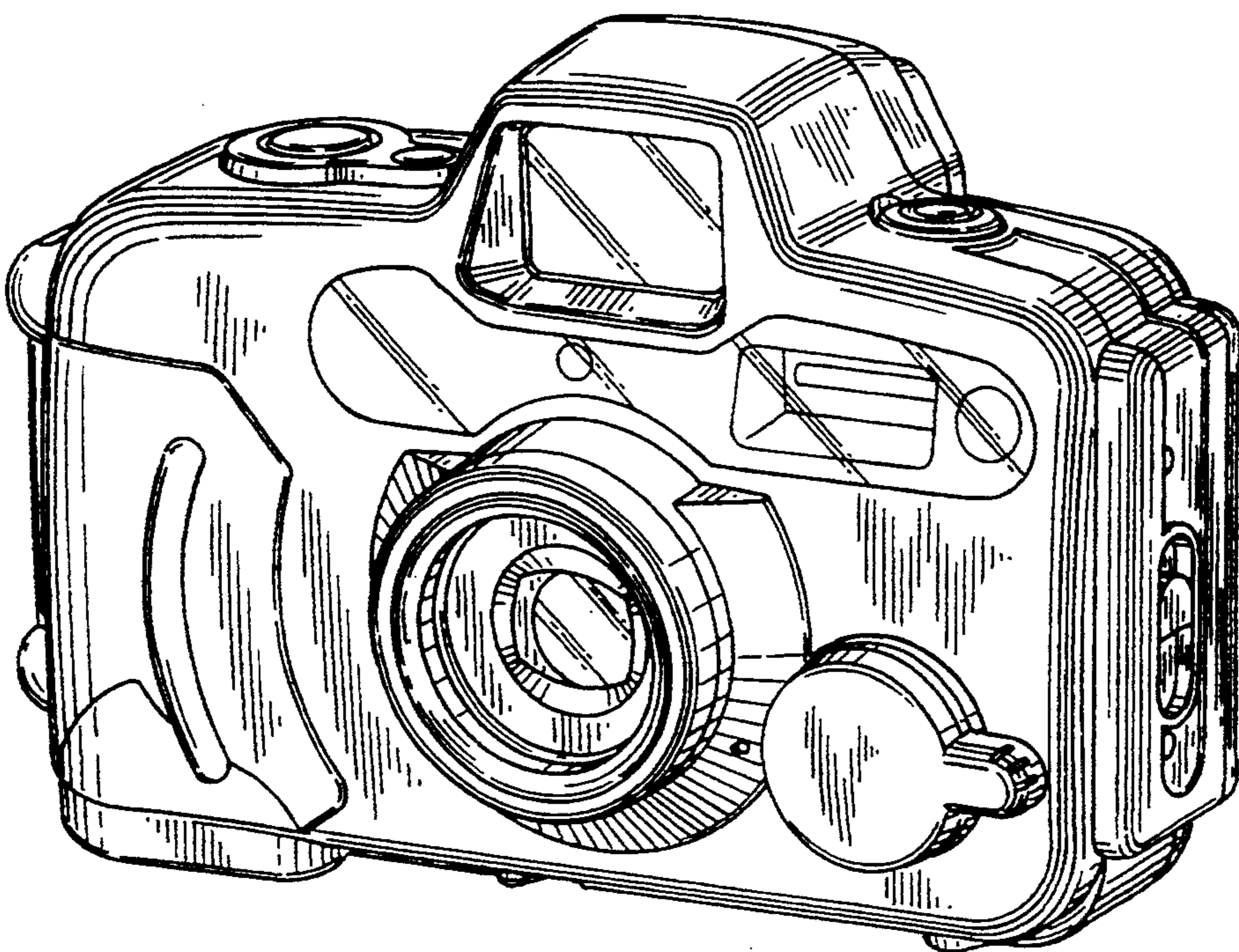

FIG. 7



UNITED STATES PATENT AND TRADEMARK OFFICE
CERTIFICATE OF CORRECTION

PATENT NO. : Des. 360,218

DATED : July 11, 1995

INVENTOR : SHIGETO IGARASHI, ET AL.

It is certified that errors appear in the above-identified patent and that said Letters Patent is hereby corrected as shown below:

On the title page:

[56] References Cited

U.S. Patent Documents, "D. 324,541 12/1993 Mc Bride et al." should read --D. 342,541 12/1993 Mc Bride et al.--.

Signed and Sealed this
Seventeenth Day of October, 1995

Attest:



BRUCE LEHMAN

Attesting Officer

Commissioner of Patents and Trademarks