



US00D360210S

# United States Patent [19]

Rudkiewicz et al.

[11] Patent Number: **Des. 360,210**

[45] Date of Patent: **\*\* Jul. 11, 1995**

[54] **HANDSFREE OPERATION HOLDER FOR A PORTABLE TELEPHONE**

[75] Inventors: **Tomek Rudkiewicz; Robert Hellier,**  
both of Turku, Finland

[73] Assignee: **Nokia Mobile Phones Ltd.,** Salo,  
Finland

[\*\*] Term: **14 Years**

[21] Appl. No.: **20,710**

[22] Filed: **Mar. 29, 1994**

### [30] Foreign Application Priority Data

Sep. 30, 1993 [GB] United Kingdom ..... 2034229

[52] U.S. Cl. .... **D14/243; D14/142;**  
D14/243

[58] Field of Search ..... D14/243, 114, 251, 253,  
D14/142, 138, 240, 140, 149-151; D13/107,  
108; 379/58-61, 441, 440, 454, 455, 419, 420,  
428

### [56] References Cited

#### U.S. PATENT DOCUMENTS

- D. 210,291 2/1968 Zannuso et al. .... D14/240
- D. 275,951 10/1984 Taylor ..... D14/151
- D. 276,809 12/1984 Taylor ..... D14/253

- D. 319,052 8/1991 Major ..... D14/138
- D. 320,991 10/1991 Nagai et al. .... D14/253 X
- D. 321,885 11/1991 Sheldrake ..... D14/253
- D. 344,261 2/1994 Watanabe ..... D13/107
- D. 344,708 3/1994 Ho ..... D13/108
- D. 350,528 9/1994 Bent et al. .... D13/108
- D. 350,545 9/1994 Olkkola et al. .... D14/142 X
- D. 352,711 11/1994 Solomita et al. .... D14/149
- 5,052,943 10/1991 Davis ..... D14/114 X
- 5,230,016 7/1993 Yasuda ..... 379/455 X
- 5,301,224 4/1994 Major ..... 379/58

*Primary Examiner*—Jeffrey Asch  
*Attorney, Agent, or Firm*—Perman & Green

### [57] CLAIM

The ornamental design for a handsfree operation holder for a portable telephone, as shown and described.

### DESCRIPTION

FIG. 1 is a front perspective view from below and one side of a handsfree operation holder for a portable telephone showing our new design;  
 FIG. 2 is a rear perspective view from above and other side;  
 FIG. 3 is a top plan view;  
 FIG. 4 is a bottom plan view;  
 FIG. 5 is a front view;  
 FIG. 6 is a rear view; and,  
 FIG. 7 is a side view.

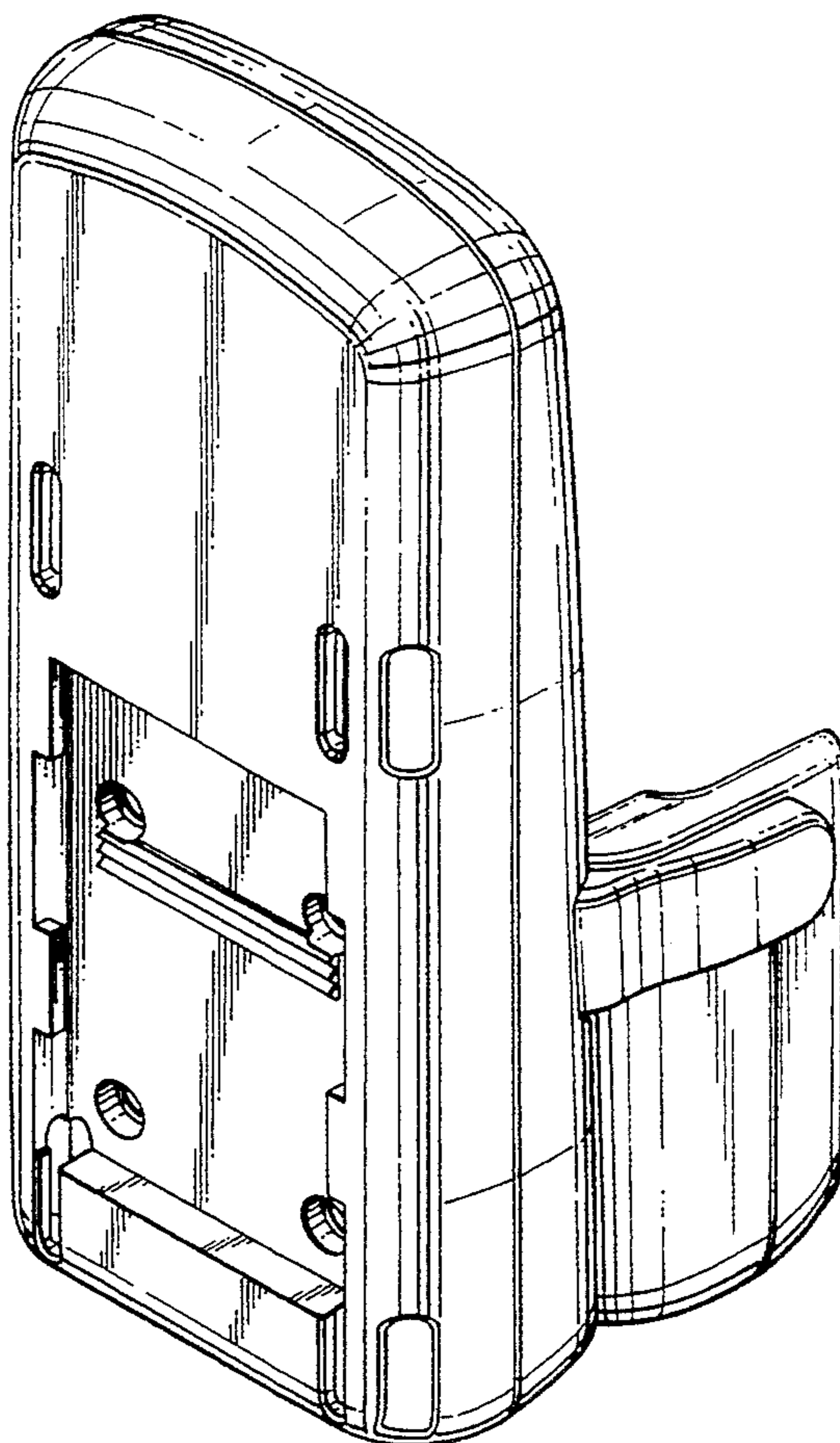
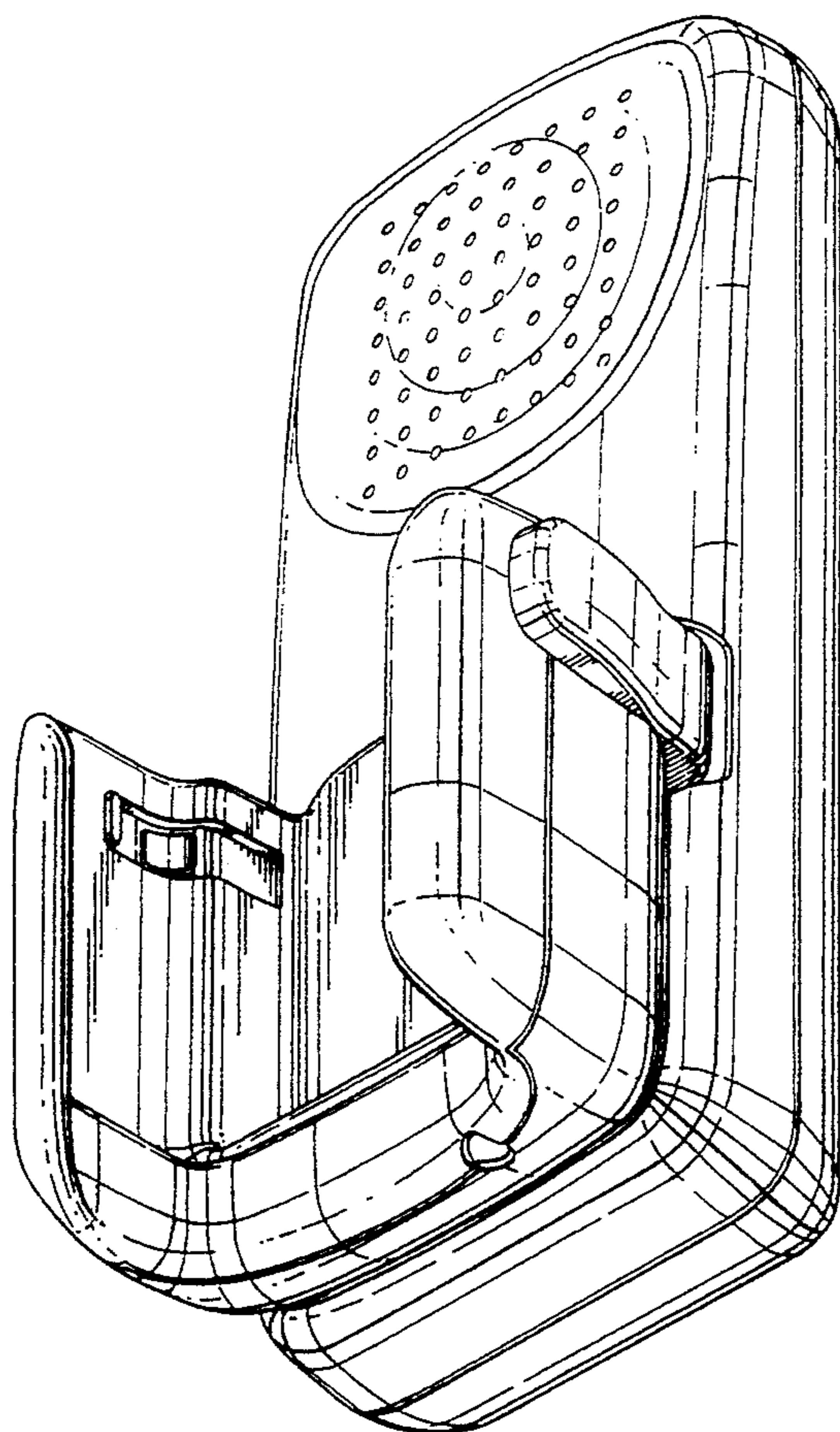

*Fig. 1*

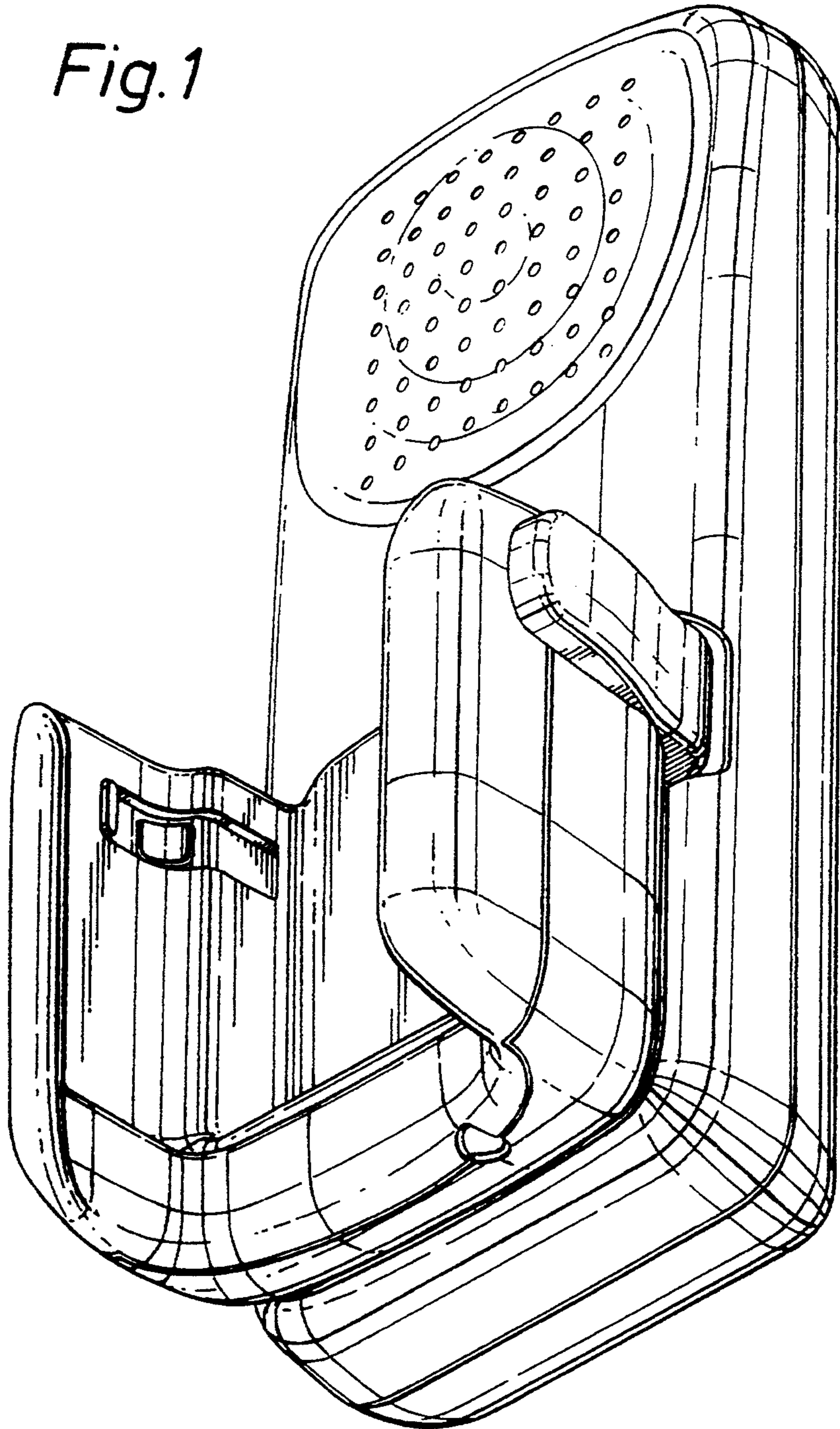

*Fig. 2*

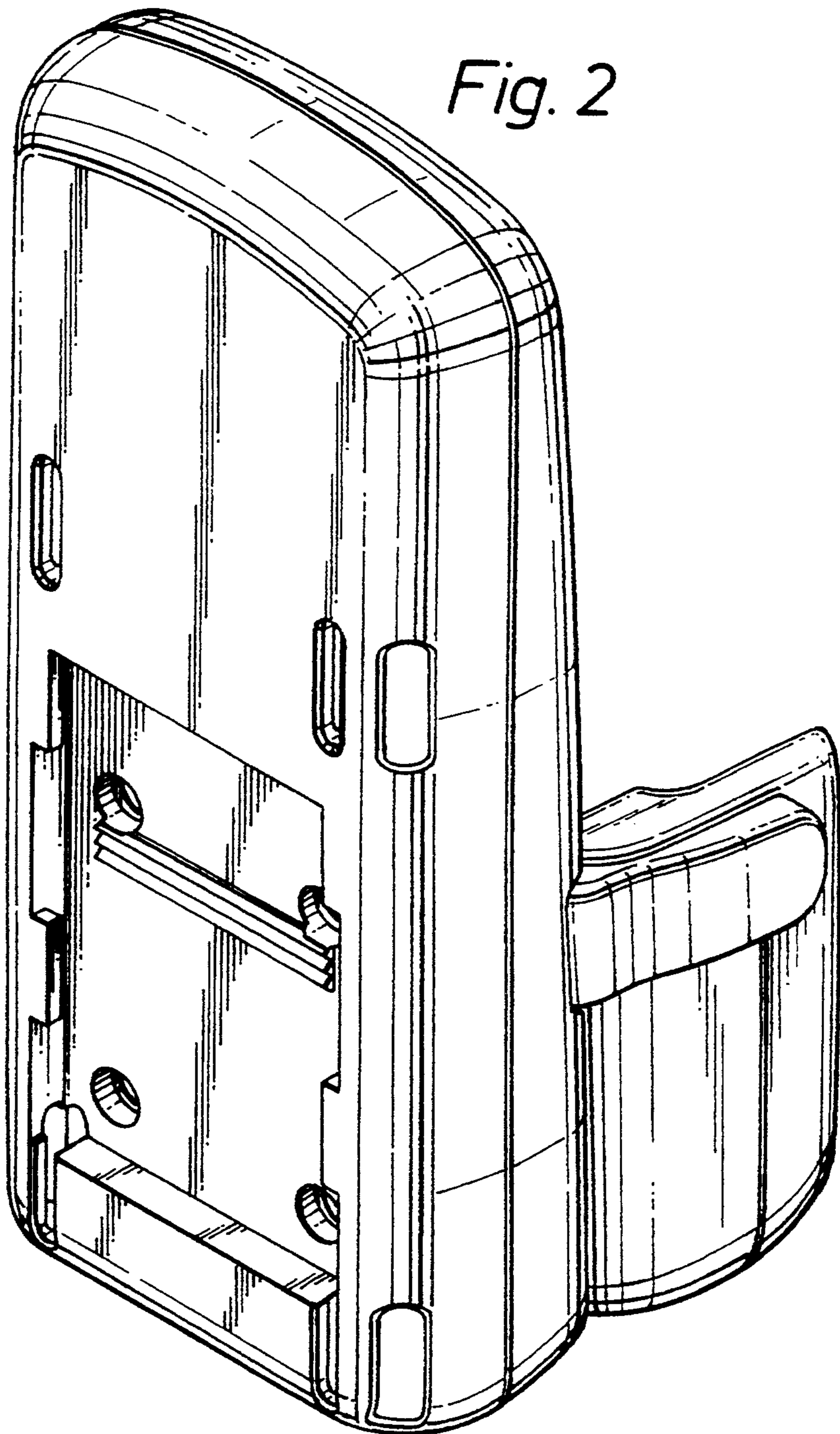

*Fig. 3*

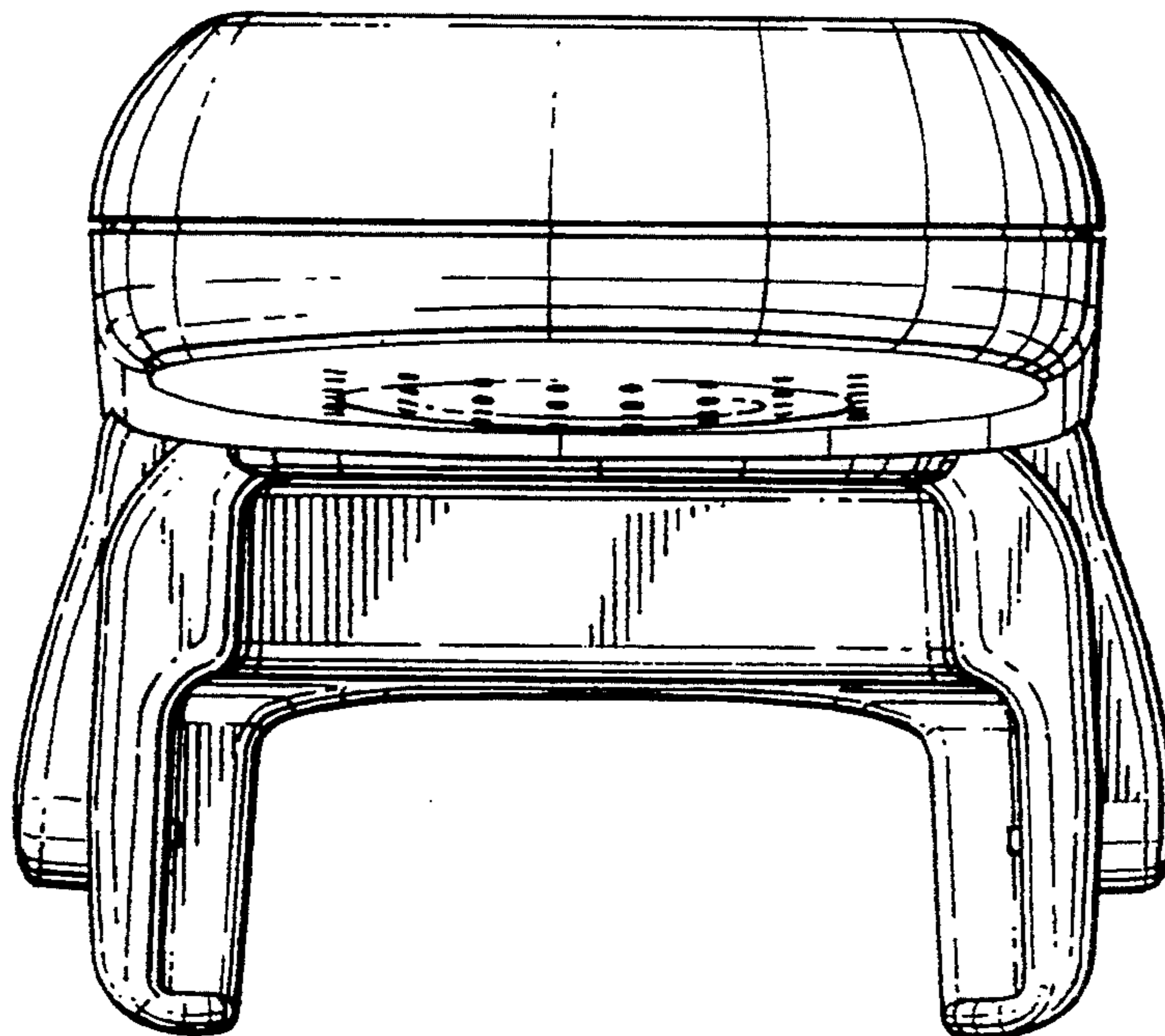

*Fig. 4*

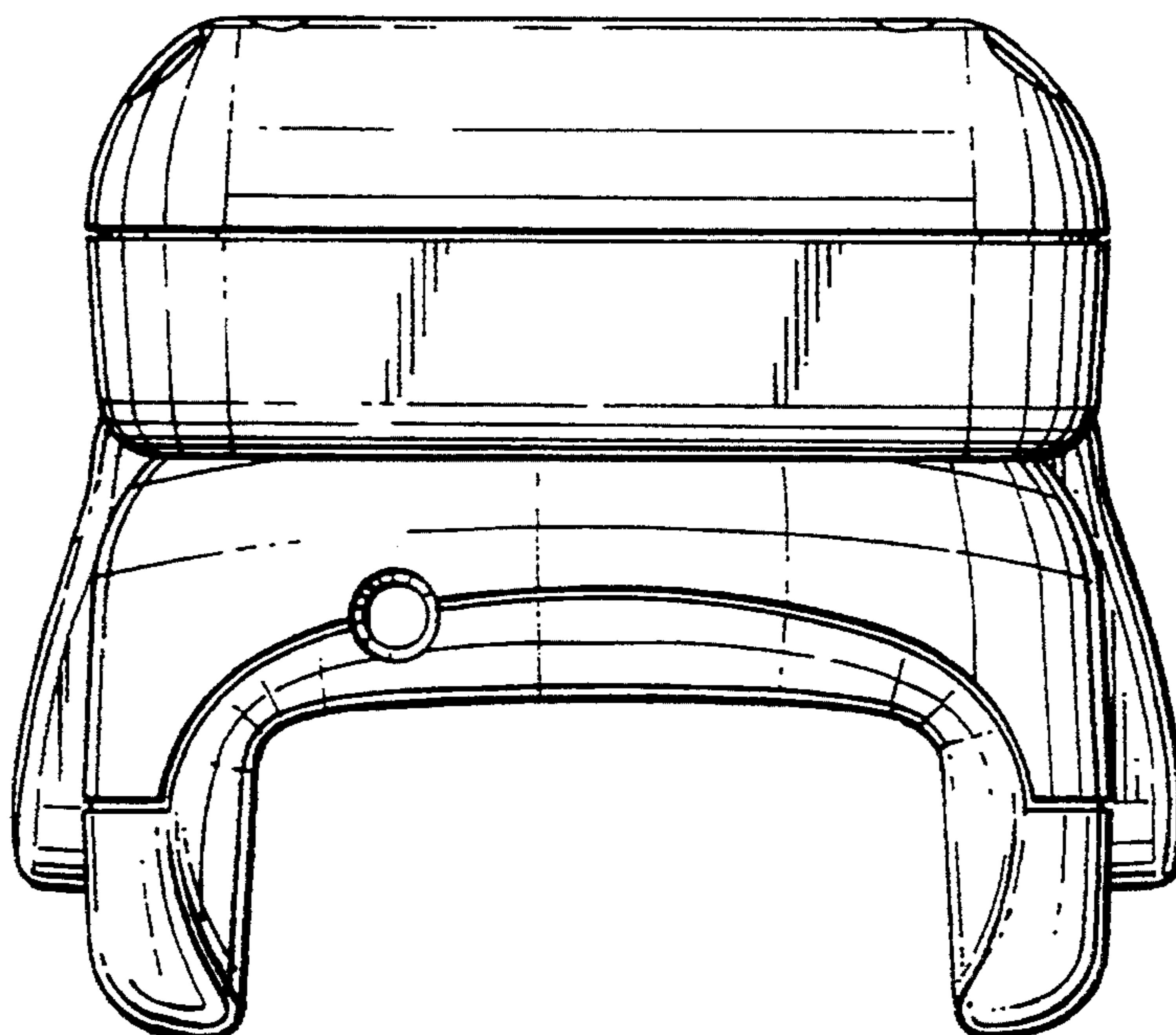

*Fig. 5*

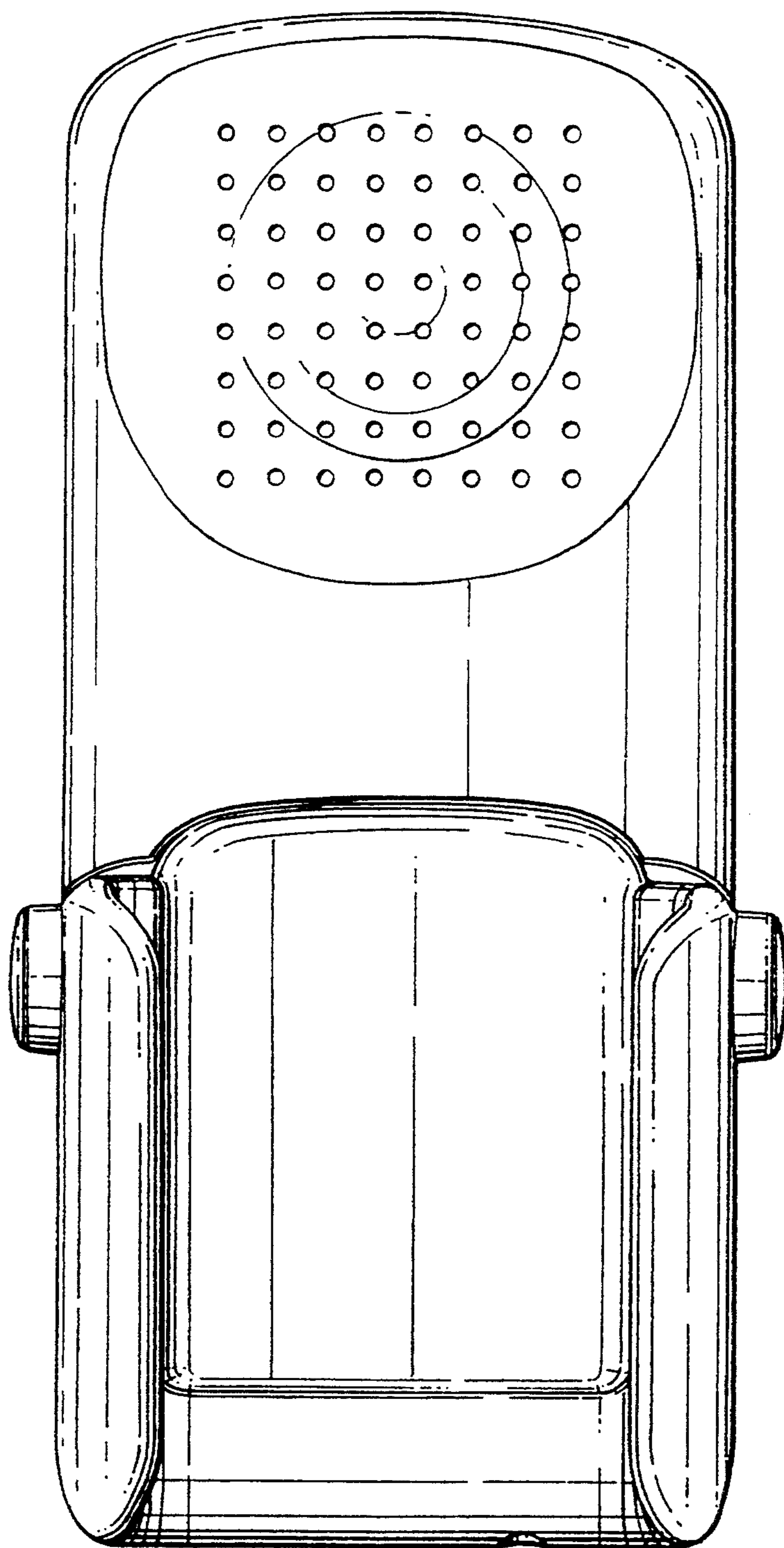

*Fig. 6*

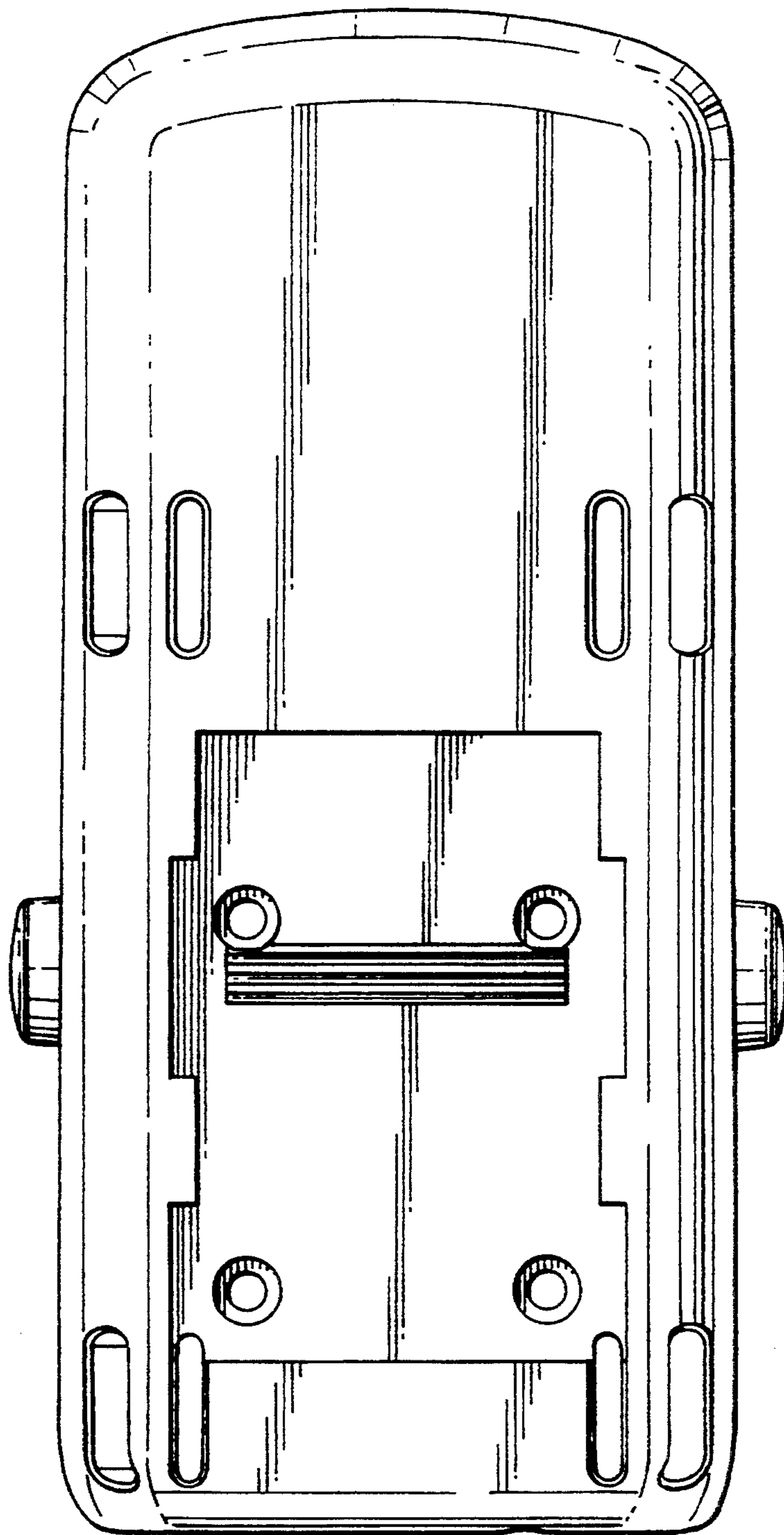

*Fig. 7*

