



US00D360125S

United States Patent [19]

[11] Patent Number: **Des. 360,125**

Taylor

[45] Date of Patent: **** Jul. 11, 1995**

[54] PADLOCK

[75] Inventor: **Jewell A. Taylor, Monterey, Calif.**

[73] Assignee: **Lock-R-Lock, Inc., Salinas, Calif.**

[**] Term: **14 Years**

[21] Appl. No.: **27,115**

[22] Filed: **Aug. 12, 1994**

Related U.S. Application Data

[62] Division of Ser. No. 716,346. Jun. 17, 1991. Pat. No. Des. 352,886.

[52] U.S. Cl. **D8/335; D8/334**

[58] Field of Search **D8/330-331, D8/334-335; 70/20-22, 24-27, 31, 35, 41, 45, 51-52; D10/106**

[56] References Cited

U.S. PATENT DOCUMENTS

D. 240,590	7/1976	Meisner	D8/334
D. 241,306	9/1976	Foote	D8/334
D. 340,199	10/1993	Taylor	D10/106
1,316,663	9/1919	Zadorozny	70/20
1,695,080	12/1928	Barrett	70/29
1,942,454	1/1934	Samburg	70/25
4,660,394	4/1987	Wu	70/25

Primary Examiner—Brian N. Vinson

Attorney, Agent, or Firm—Polster, Lieder, Woodruff & Lucchesi

[57] CLAIM

The ornamental design for a padlock, as shown and described.

DESCRIPTION

FIG. 1 is a top, front, and left side perspective view of a padlock showing my new design;

FIG. 2 is a front elevational view thereof;

FIG. 3 is a right side elevational view thereof;

FIG. 4 is a rear elevational view thereof;

FIG. 5 is a top plan view thereof;

FIG. 6 is a bottom plan view thereof;

FIG. 7 is a top, front, and left side perspective view of a padlock showing a second embodiment of my new design;

FIG. 8 is a front elevational view thereof;

FIG. 9 is a right side elevational view thereof;

FIG. 10 is a rear elevational view thereof;

FIG. 11 is a top plan view thereof;

FIG. 12 is a left side elevational view thereof;

FIG. 13 is a bottom plan view thereof;

FIG. 14 is a top, front and left side perspective view of a padlock showing a third embodiment of my new design;

FIG. 15 is a front elevational view thereof;

FIG. 16 is a right side elevational view thereof;

FIG. 17 is a rear elevational view thereof;

FIG. 18 is a top plan view thereof;

FIG. 19 is a bottom plan view thereof;

FIG. 20 is a top, front, and left side perspective view of a padlock showing a fourth embodiment of my new design;

FIG. 21 is a front elevational view thereof;

FIG. 22 is a right side elevational view thereof;

FIG. 23 is a rear elevational view thereof;

FIG. 24 is a top plan view thereof;

FIG. 25 is a bottom view thereof; and,

FIG. 26 is a left side elevational view thereof.

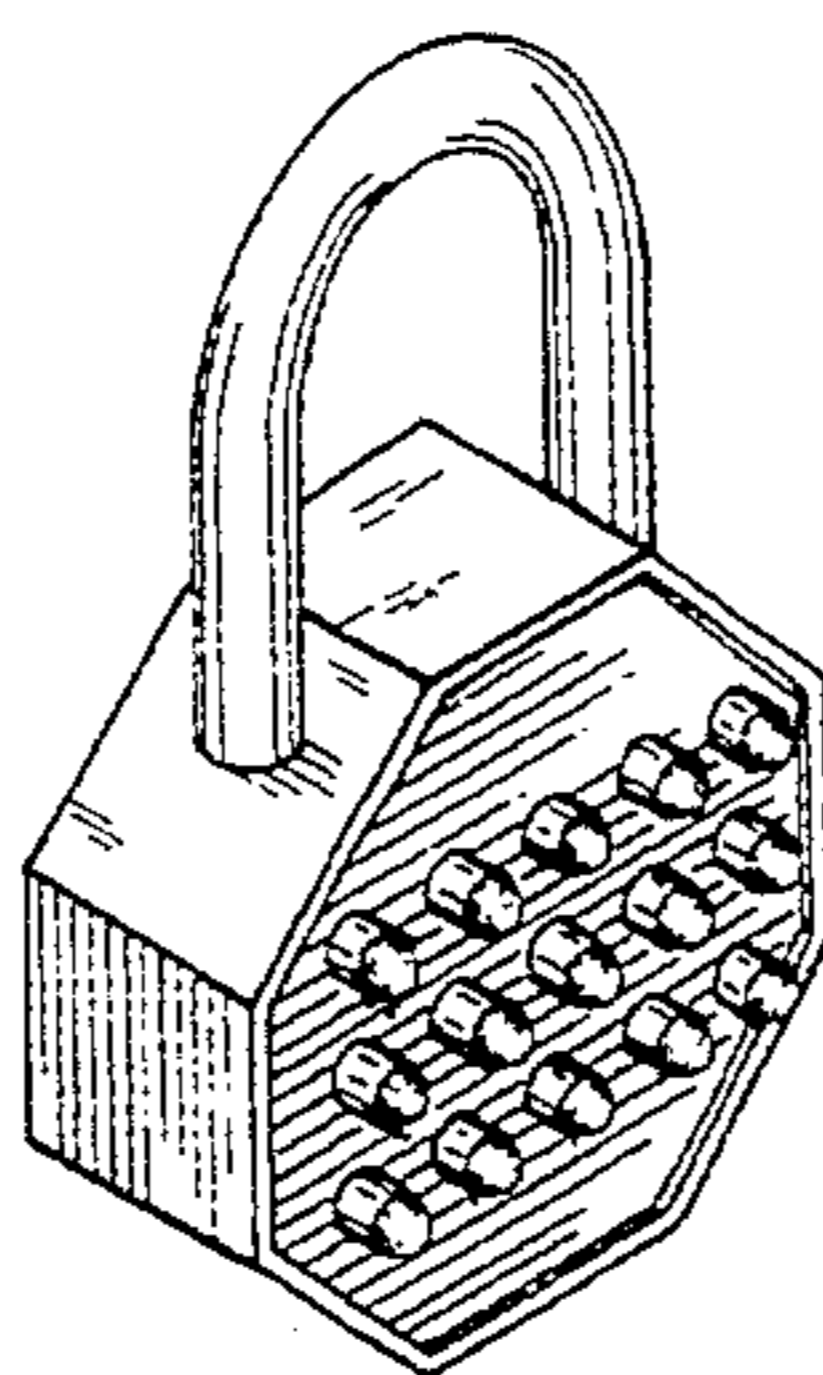
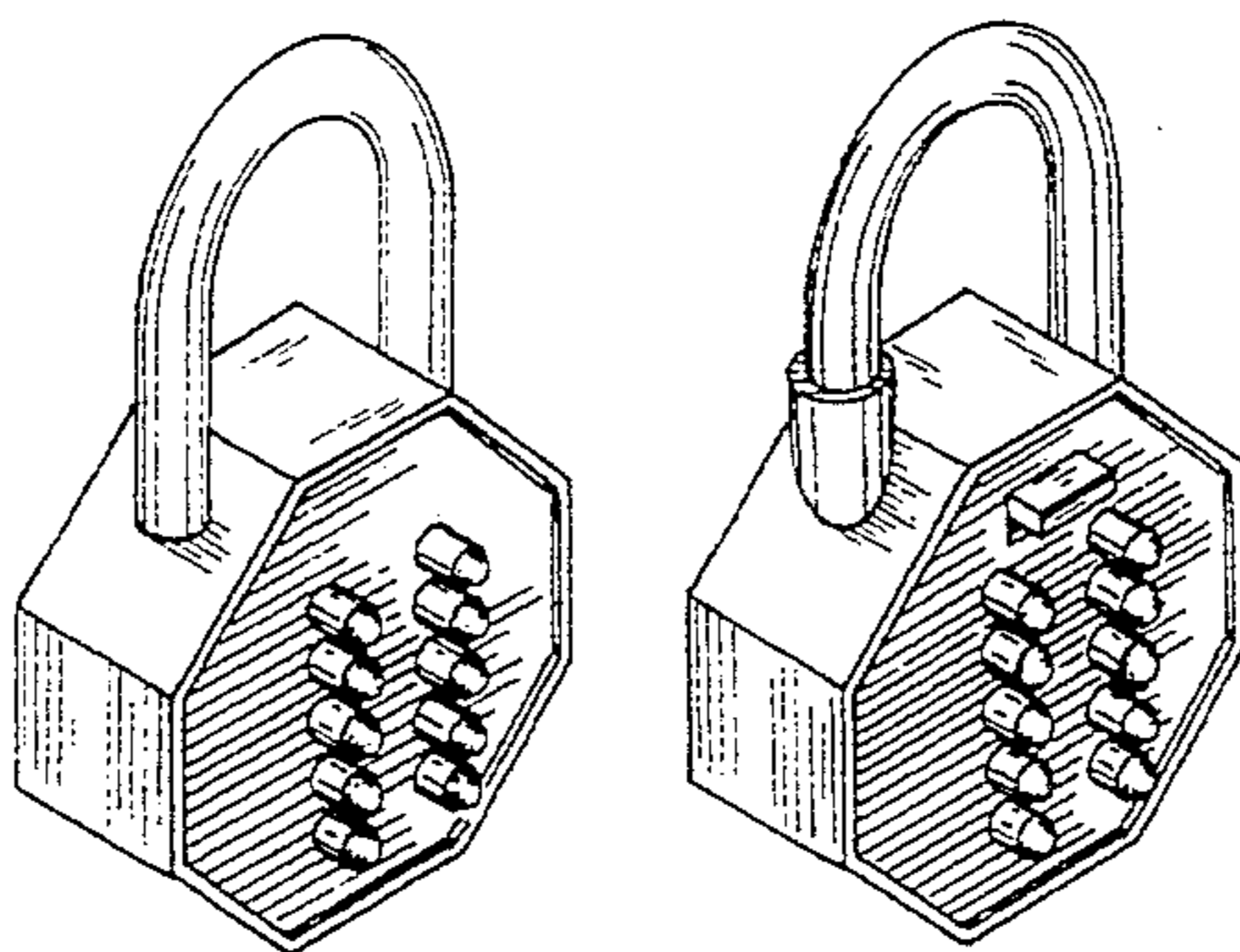

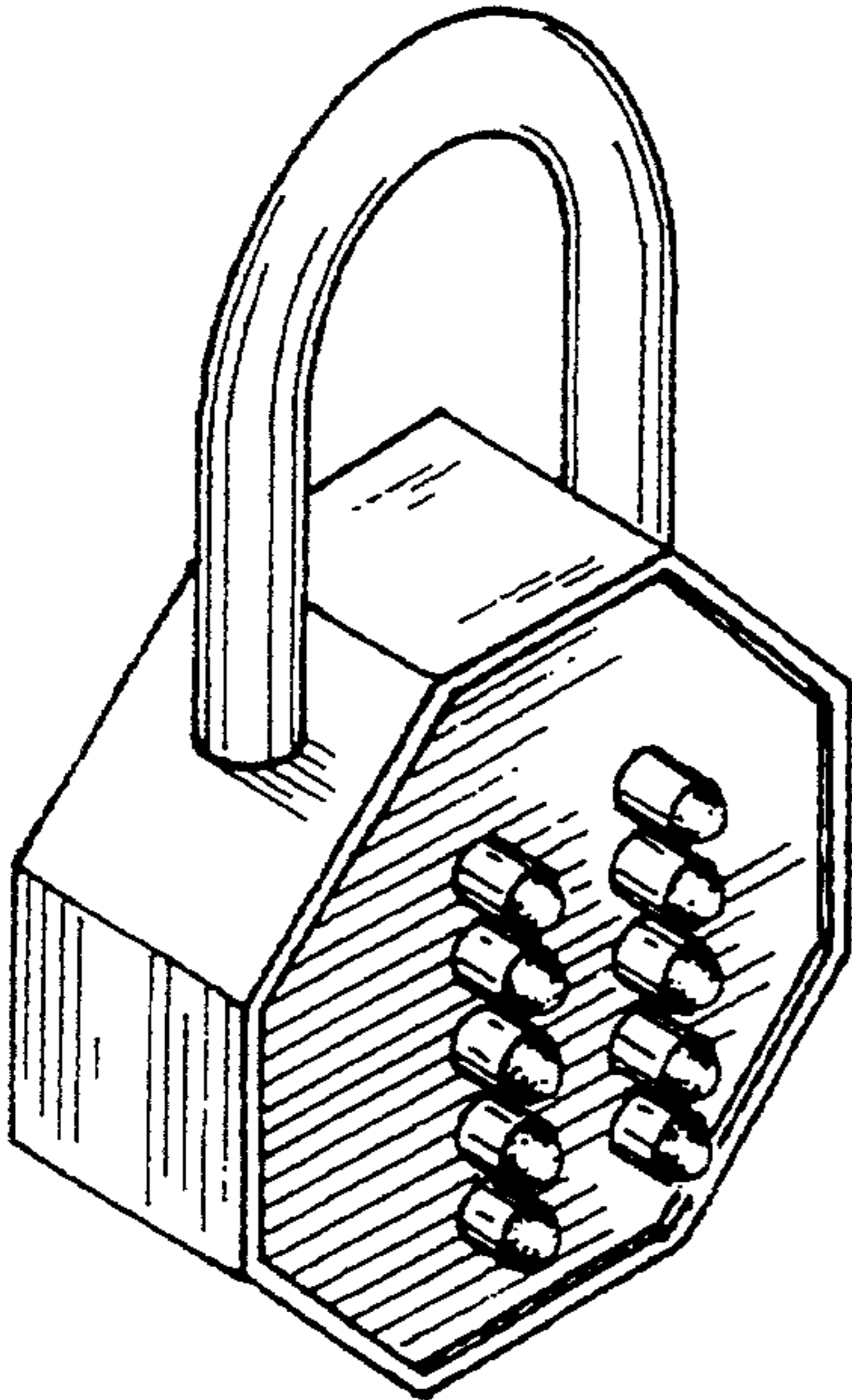

FIG. 1

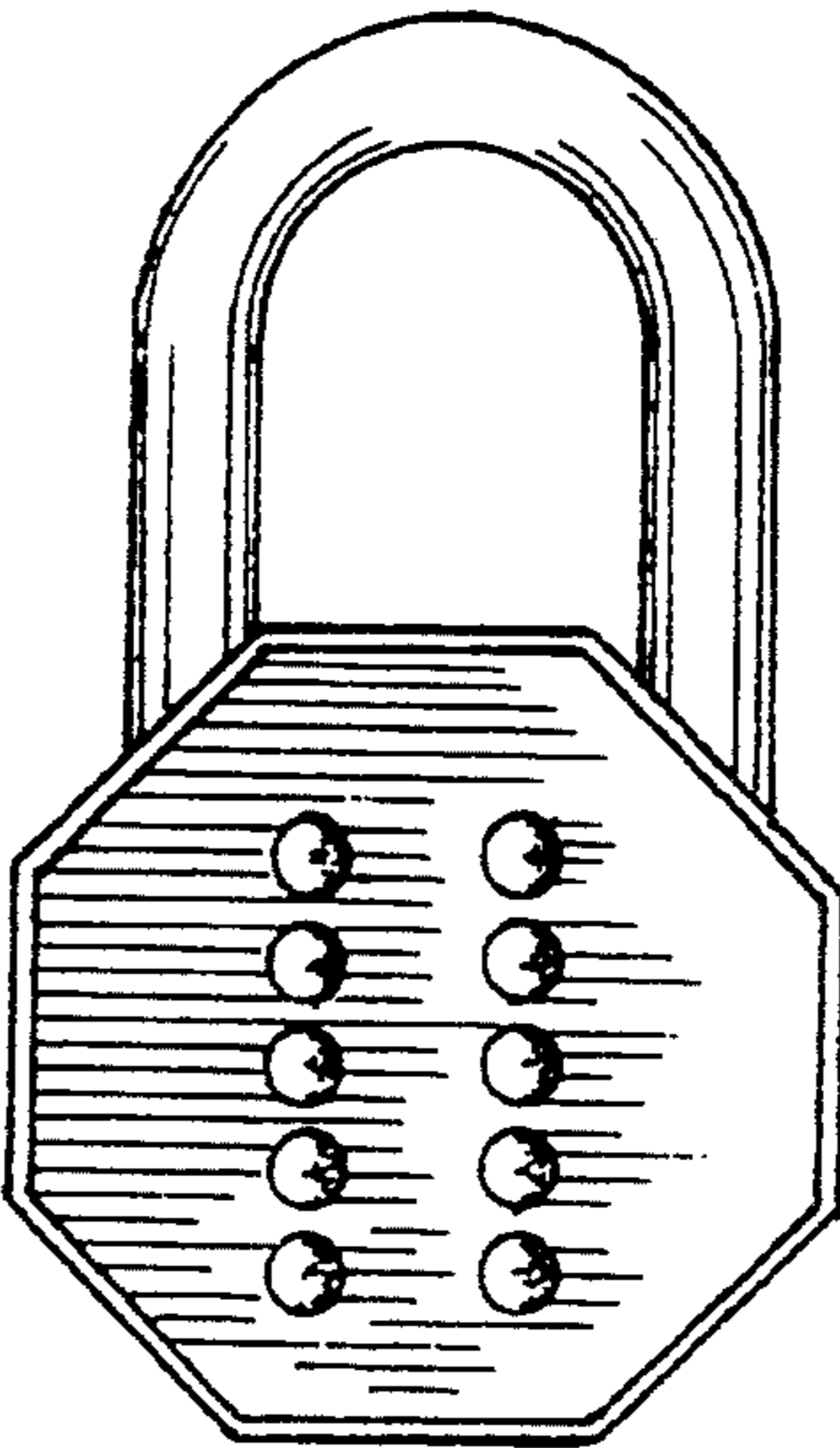

FIG. 2

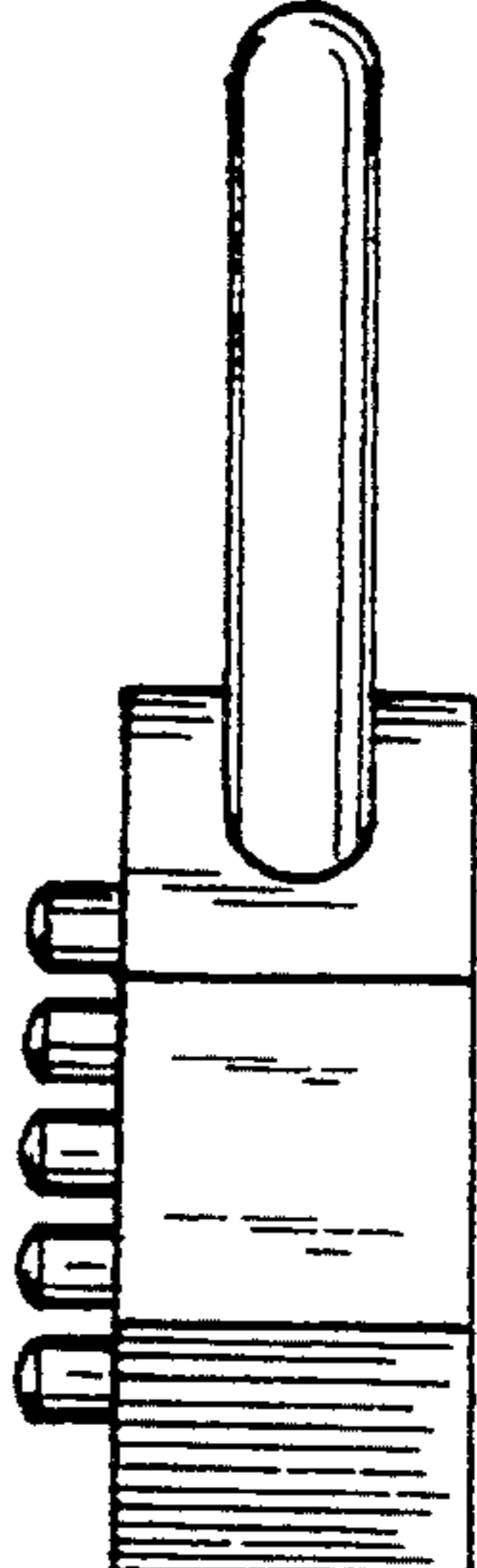

FIG. 3

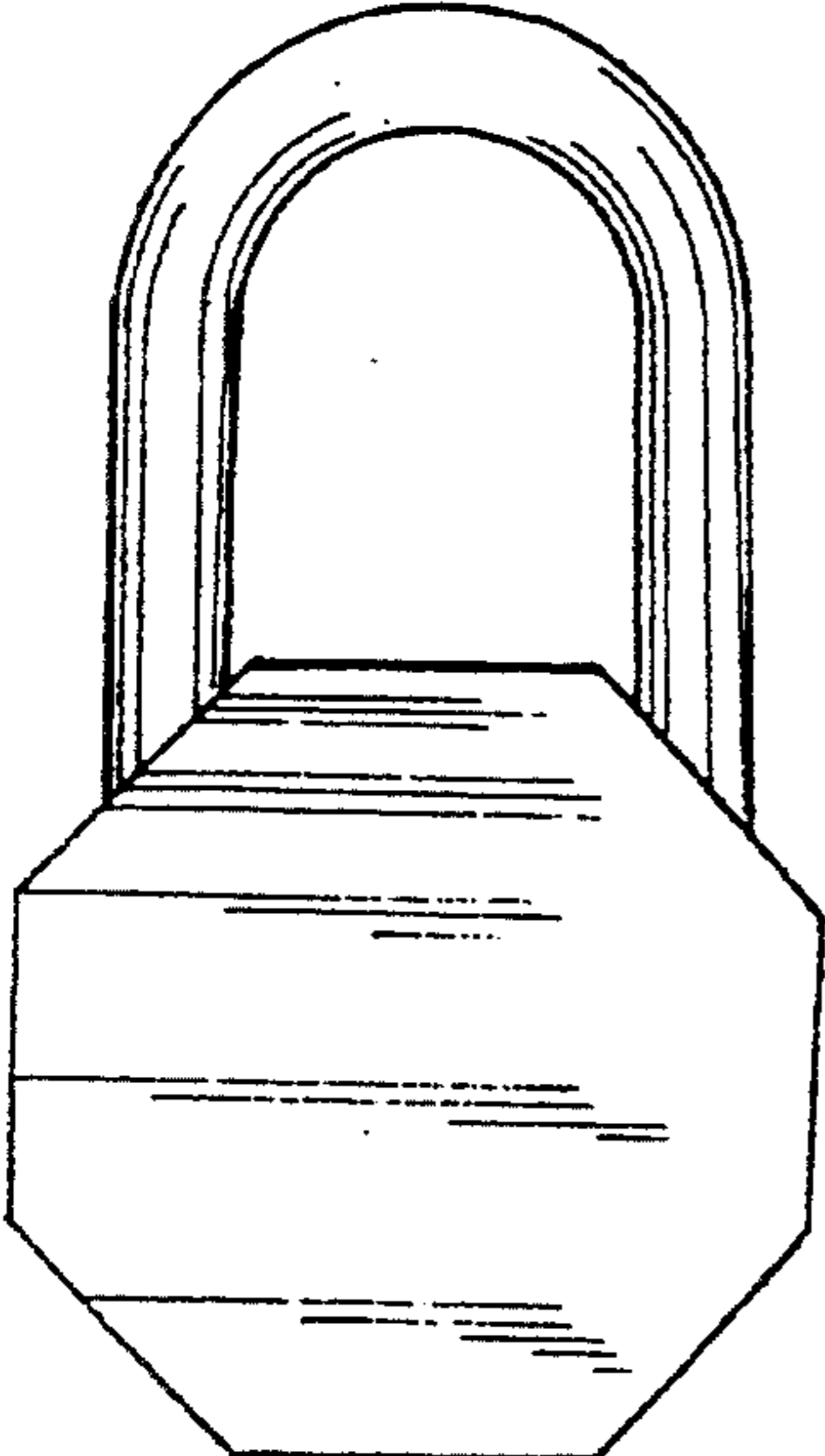

FIG. 4

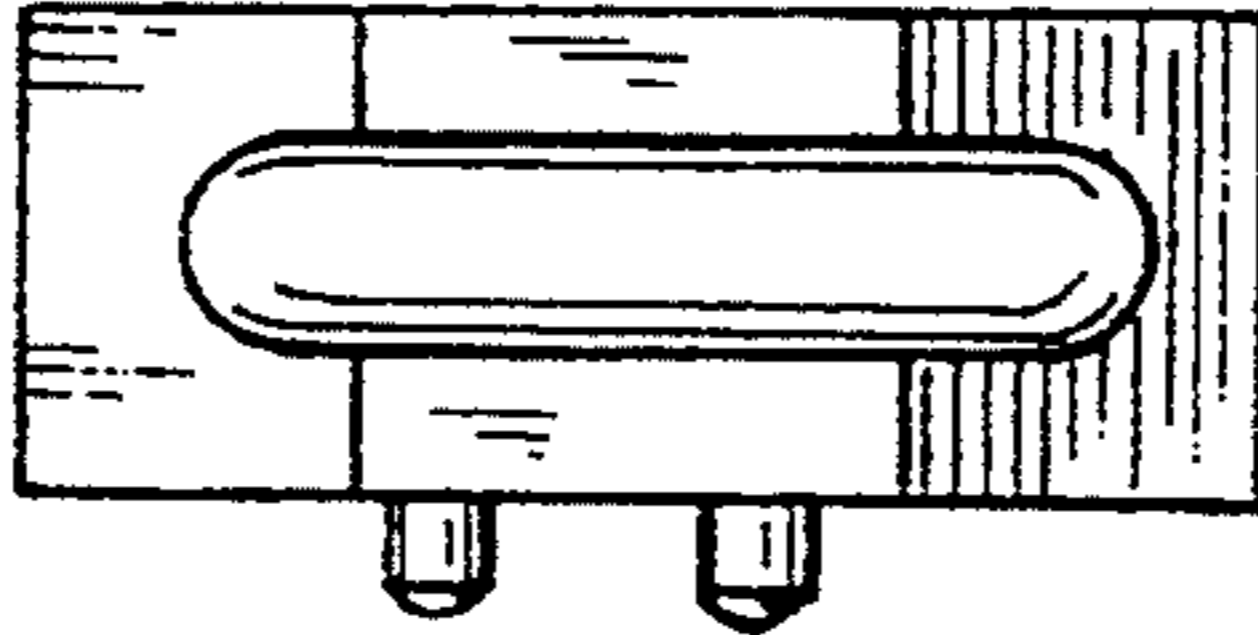

FIG. 5

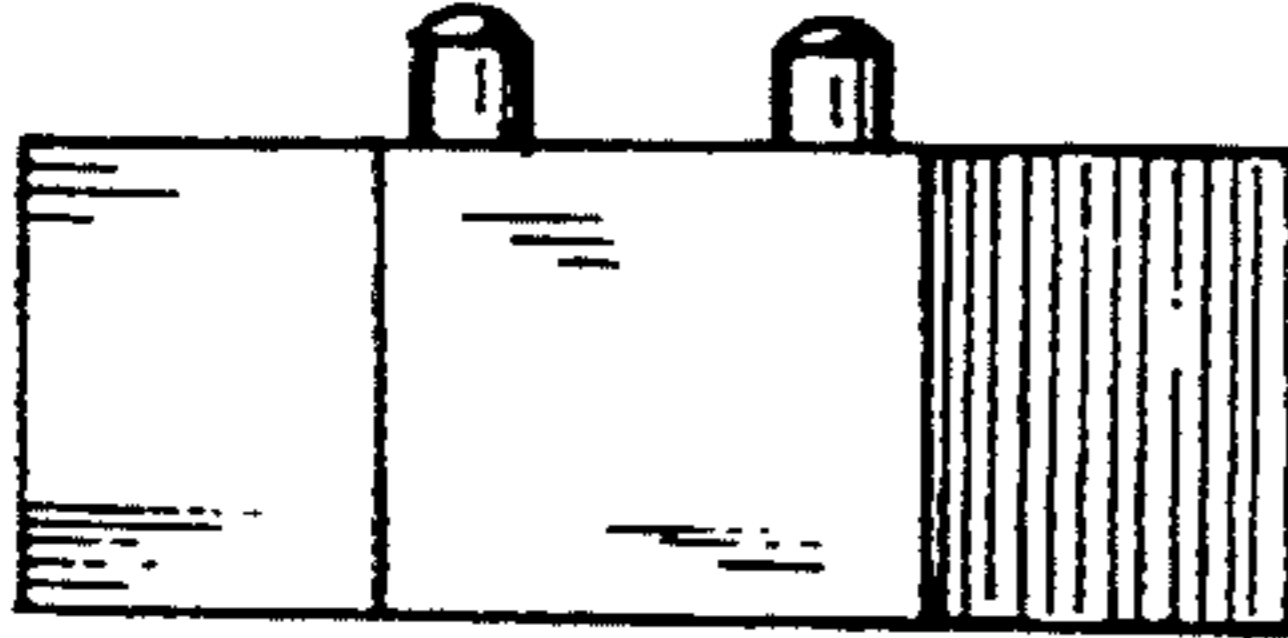

FIG. 6

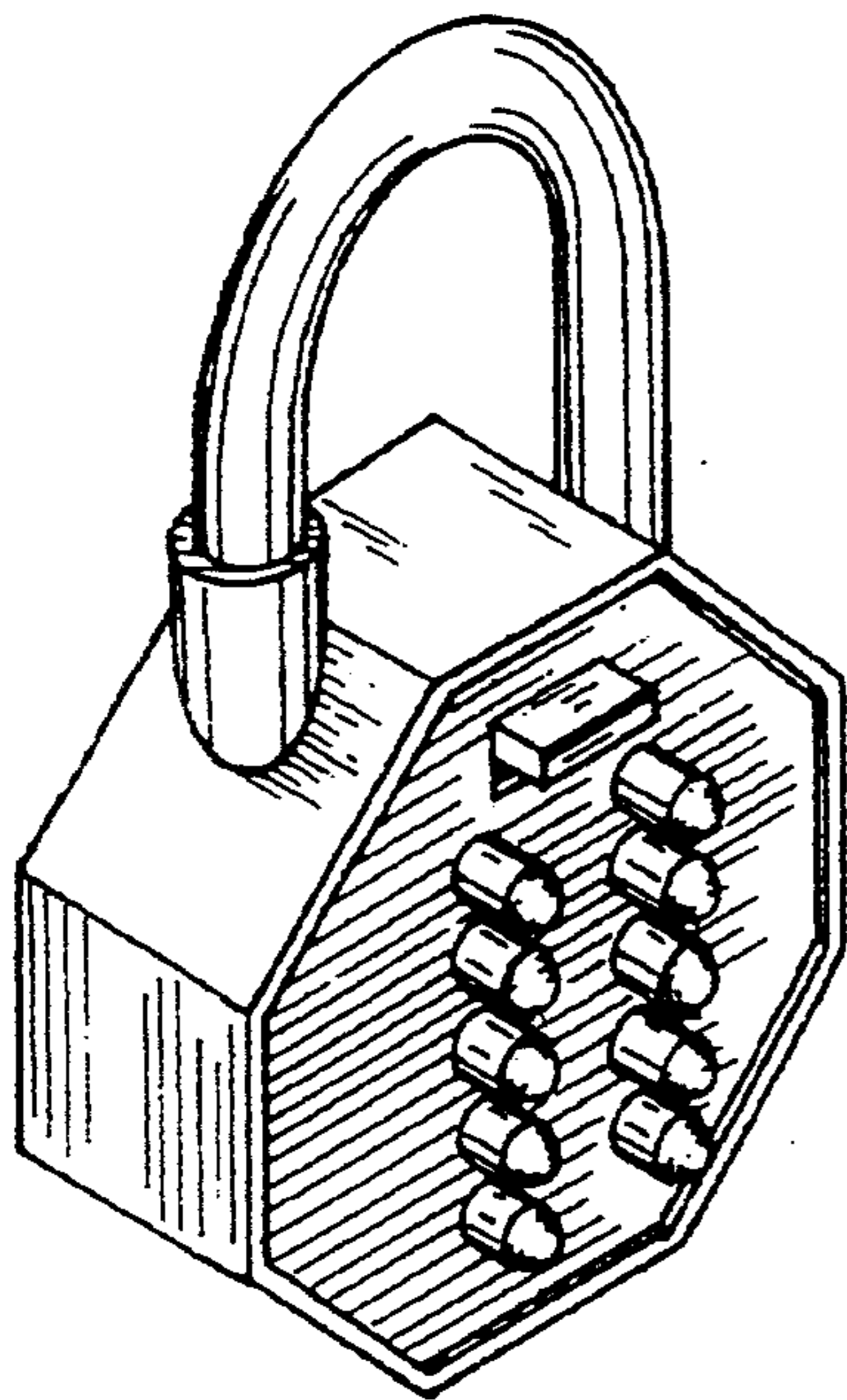

FIG. 7

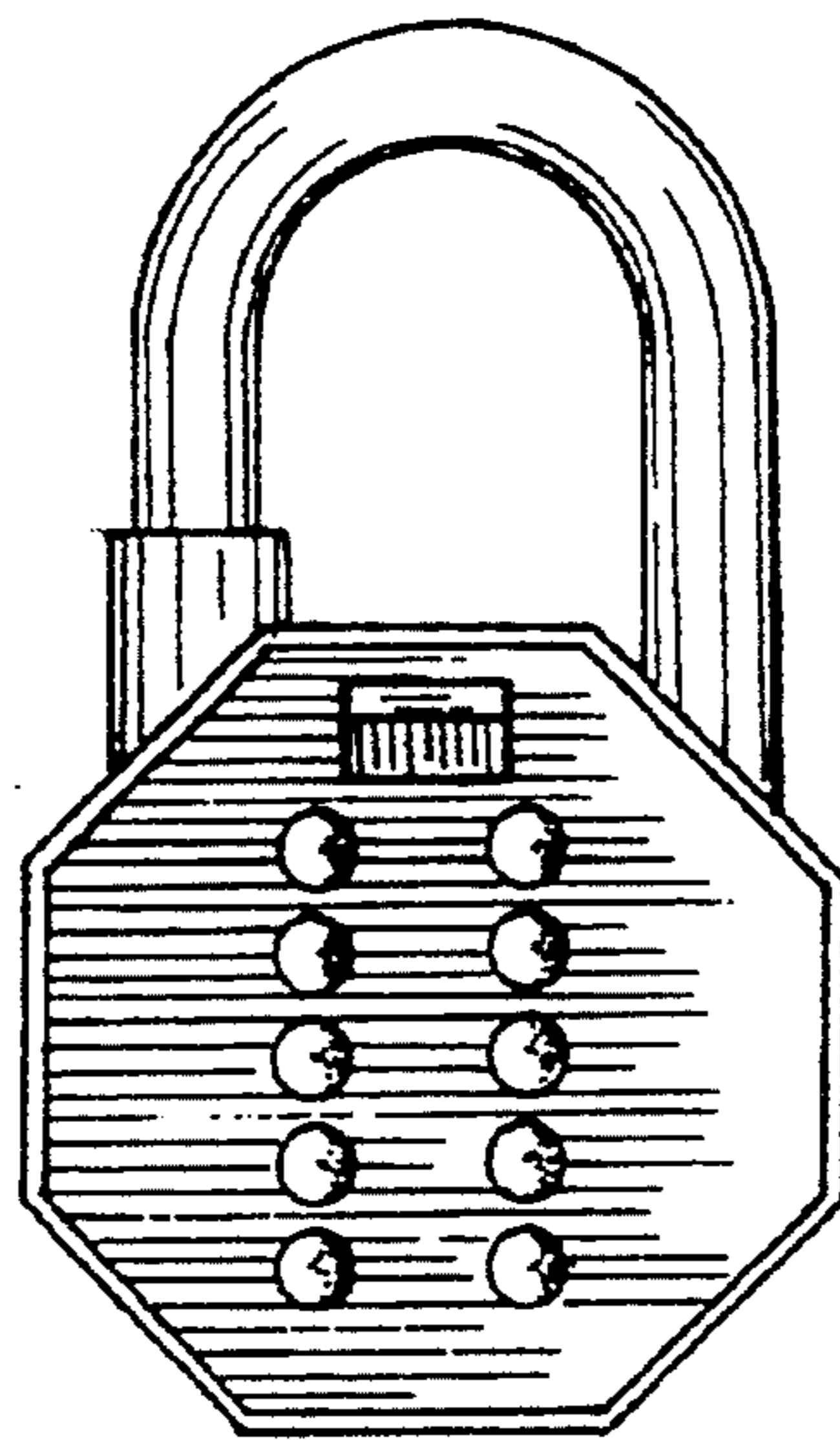

FIG. 8

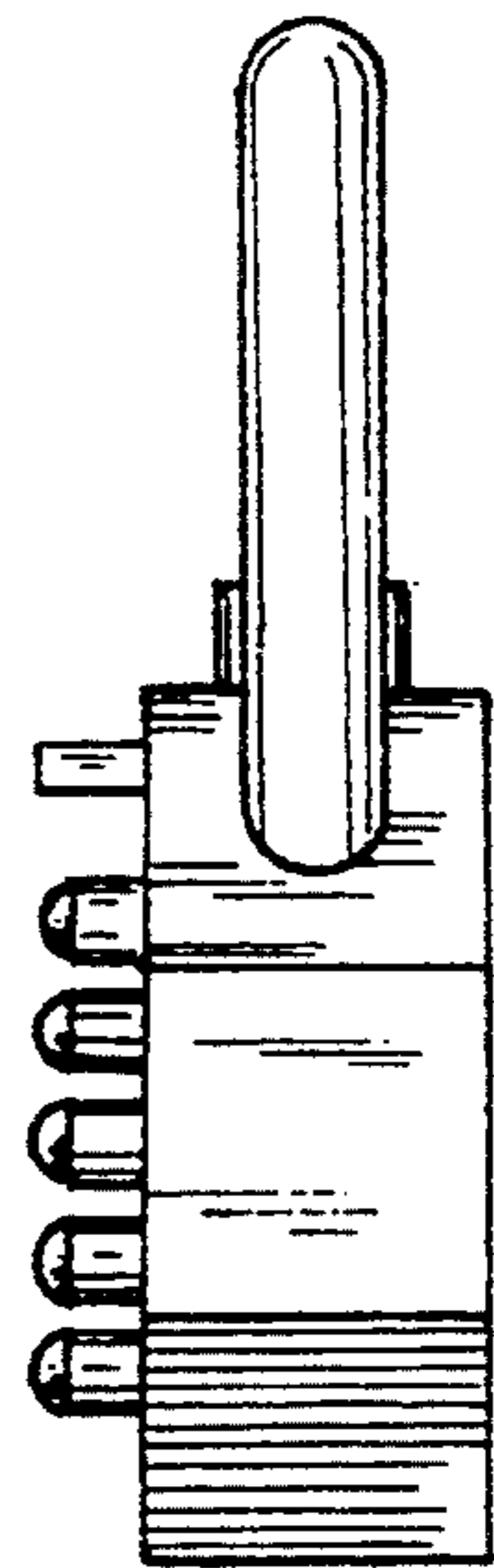

FIG. 9

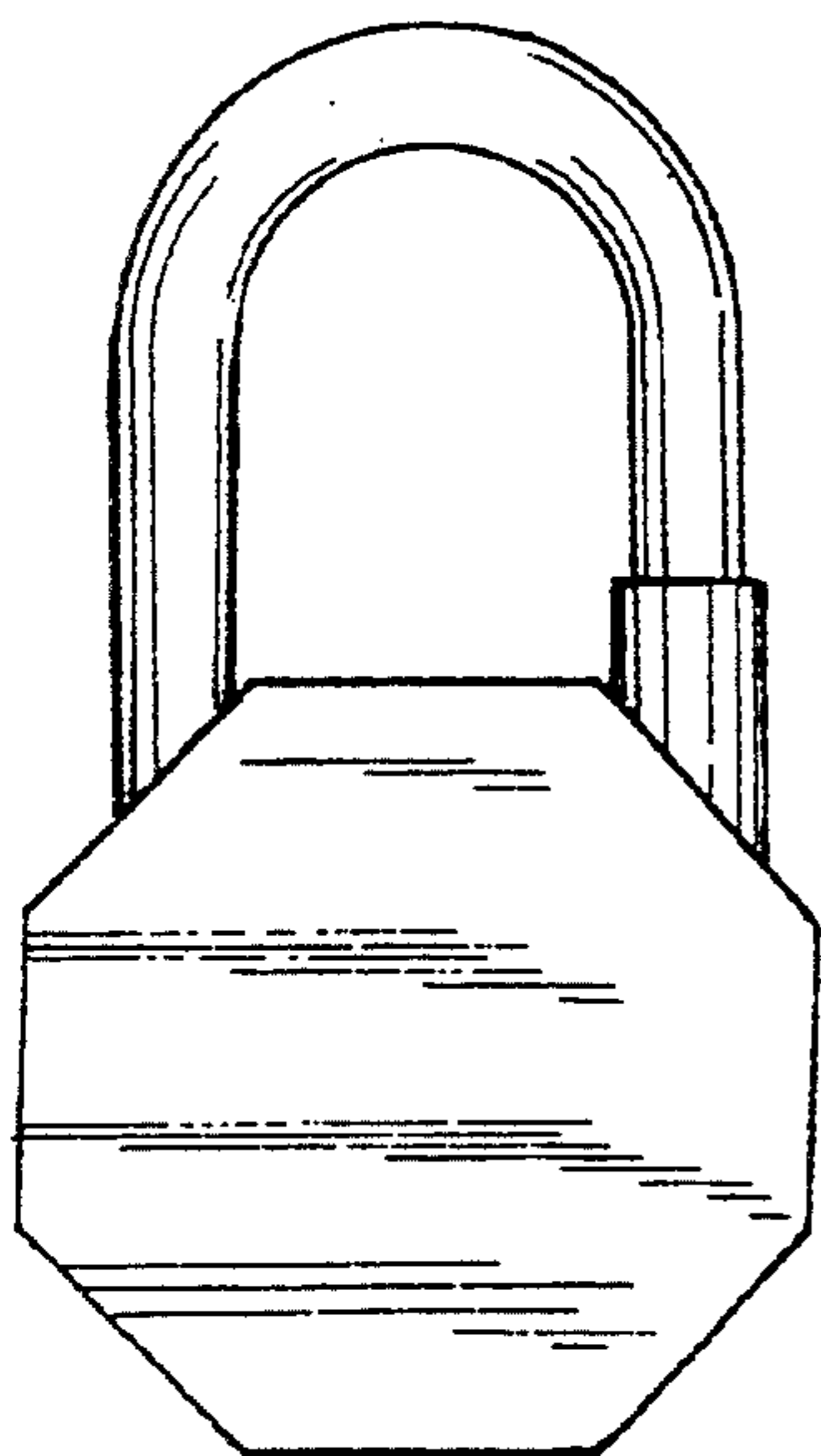

FIG. 10

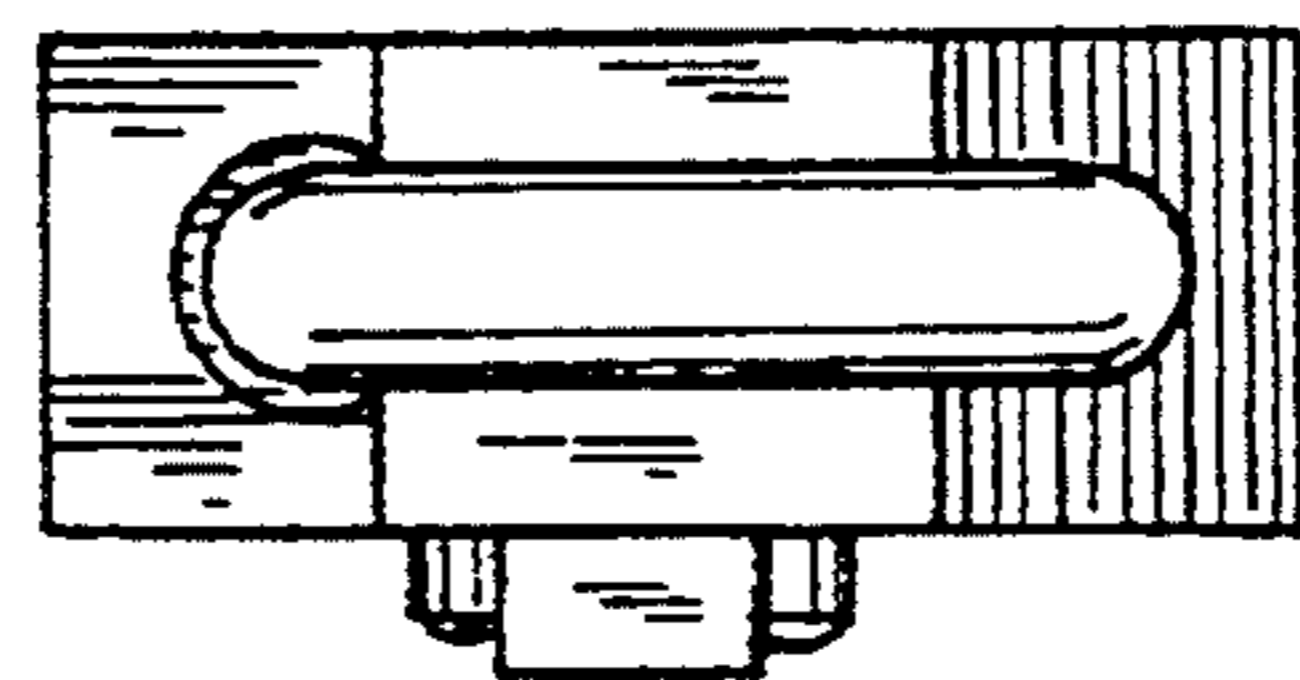

FIG. 11

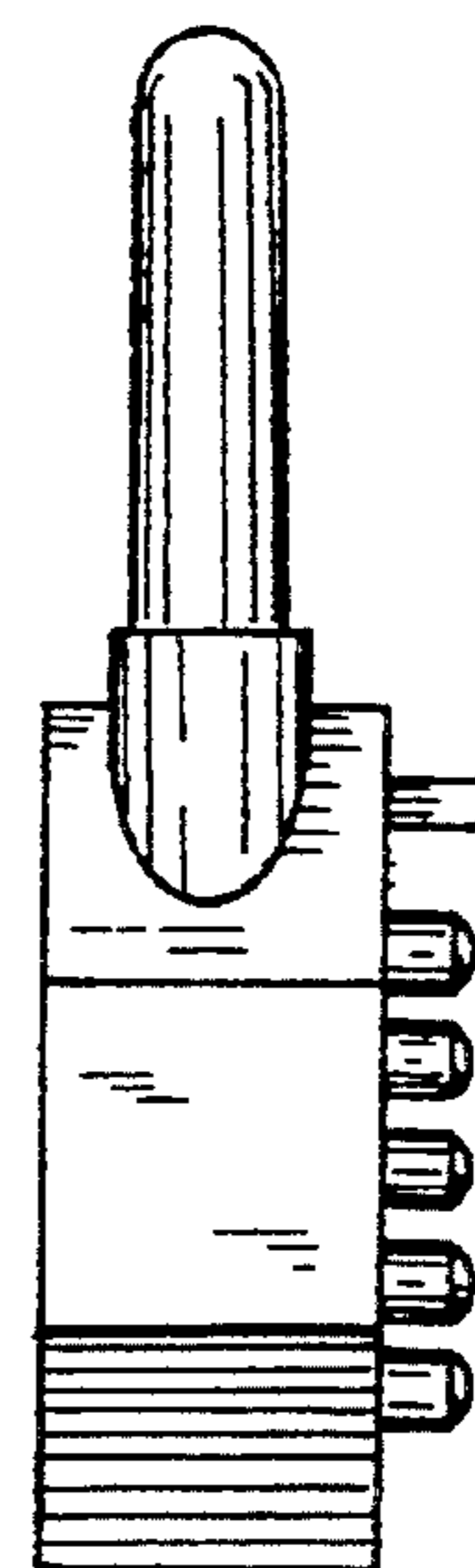

FIG. 12

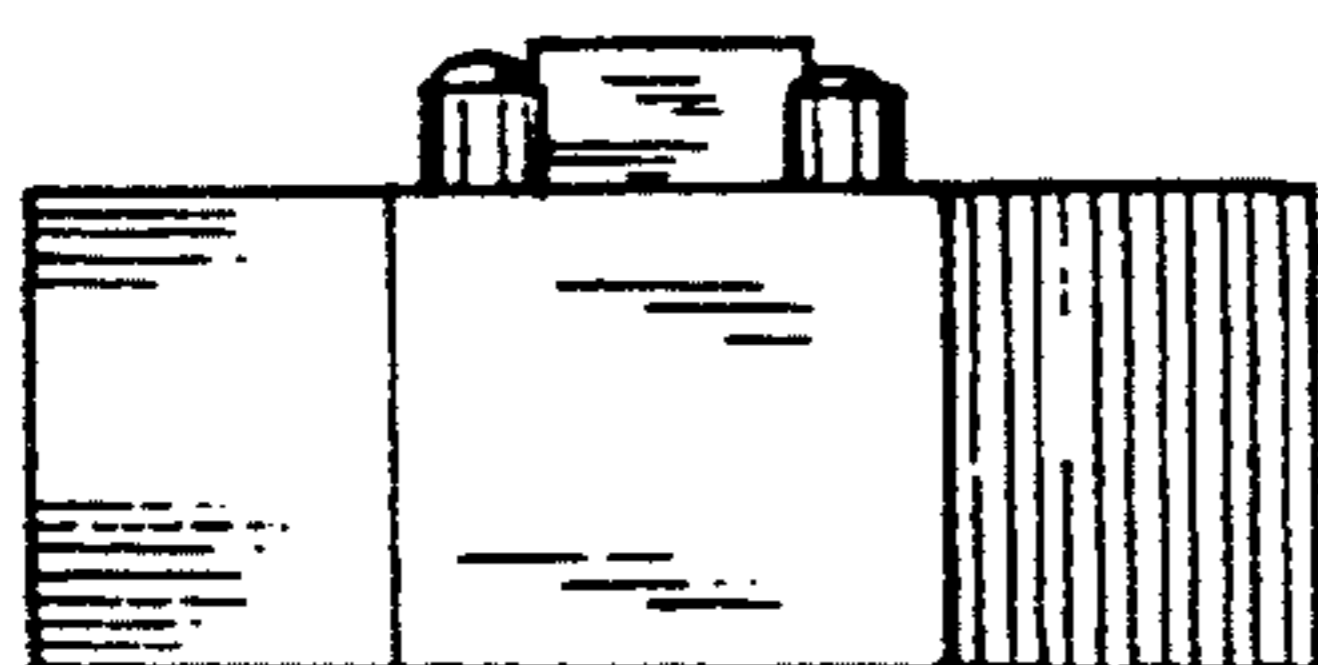

FIG. 13

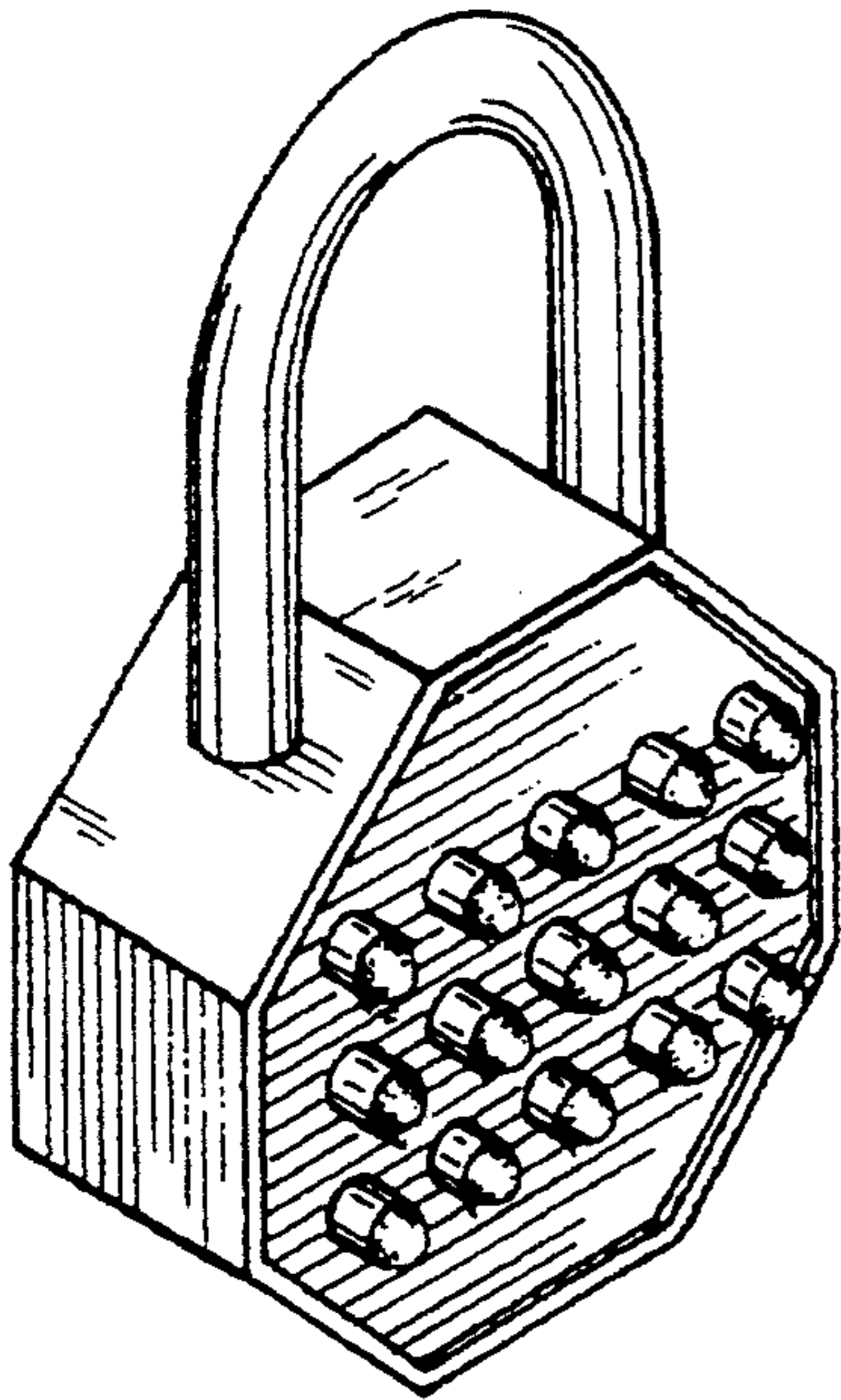

FIG. 14

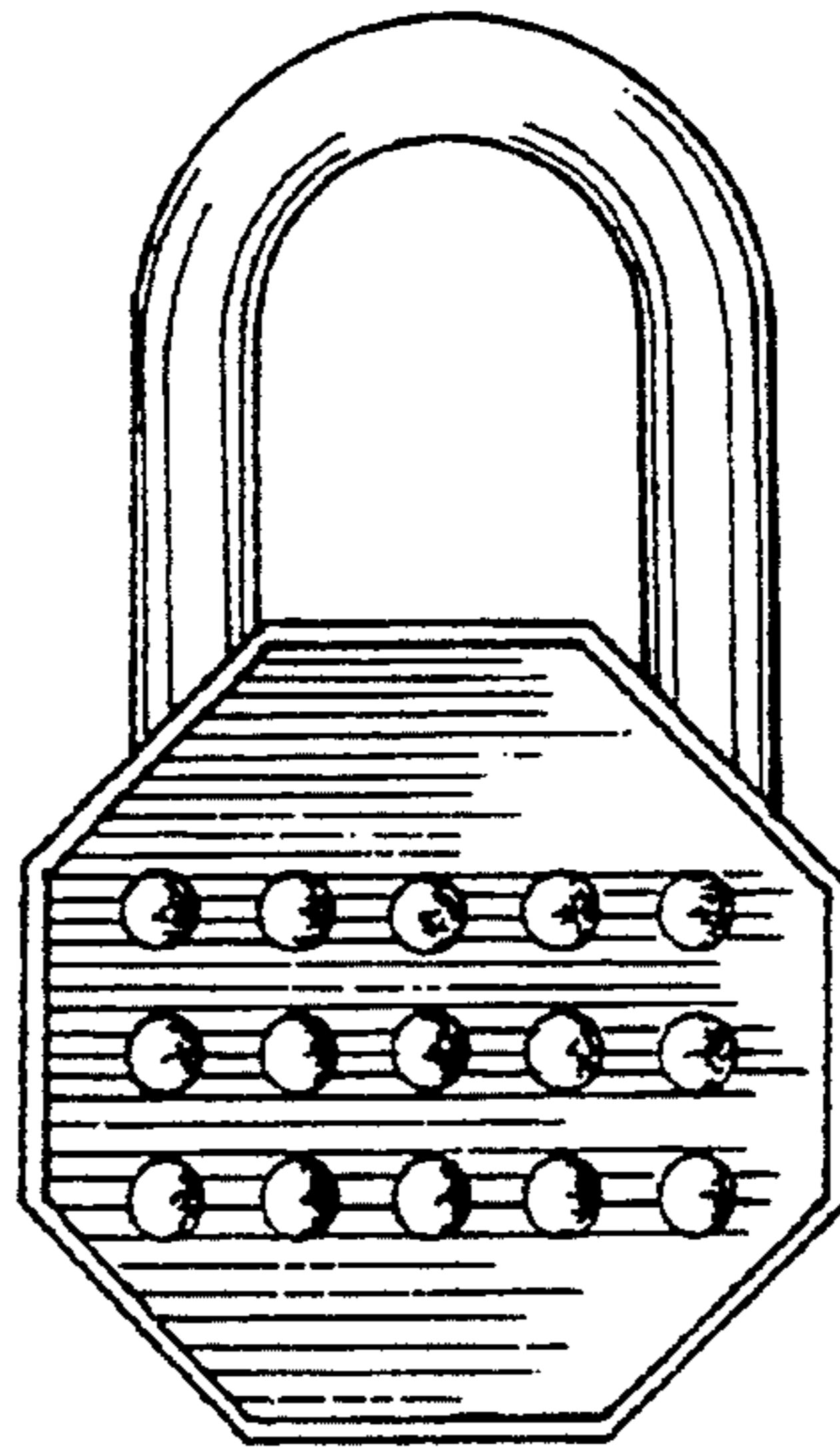

FIG. 15

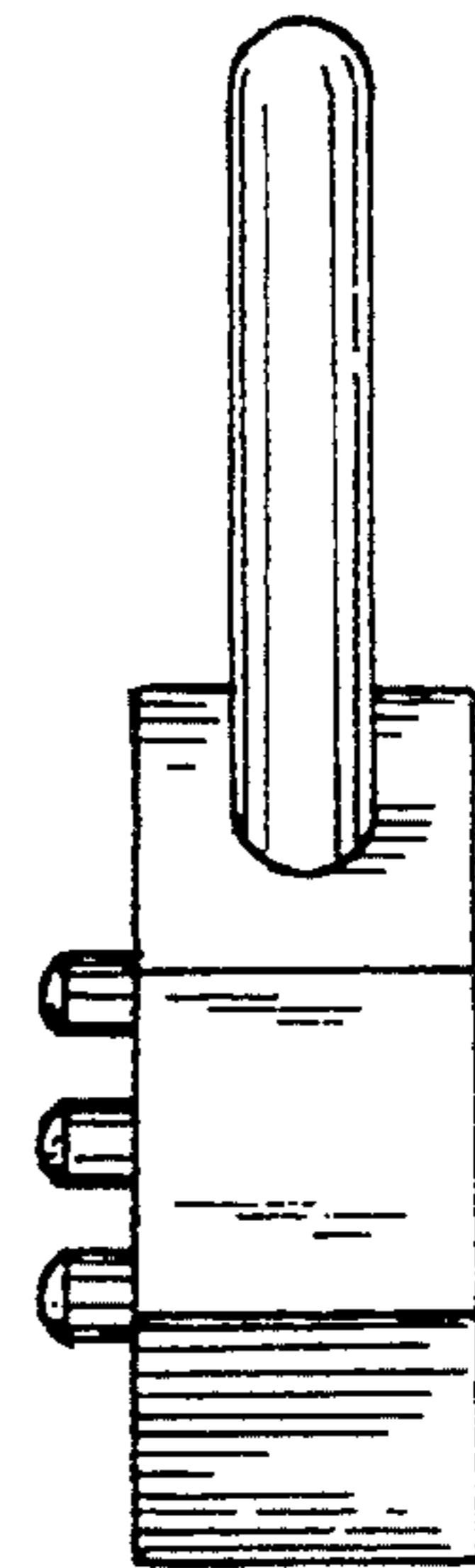

FIG. 16

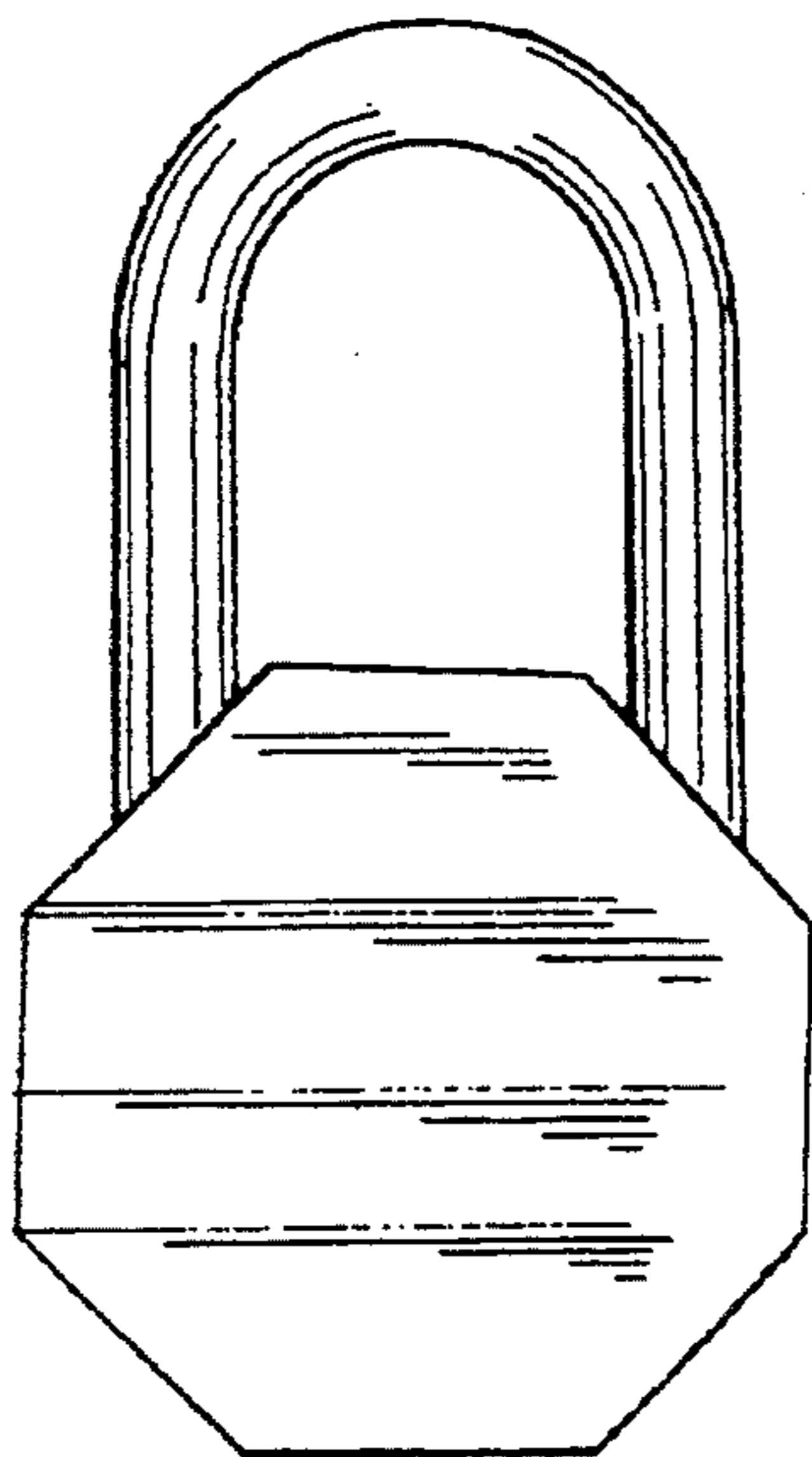

FIG. 17

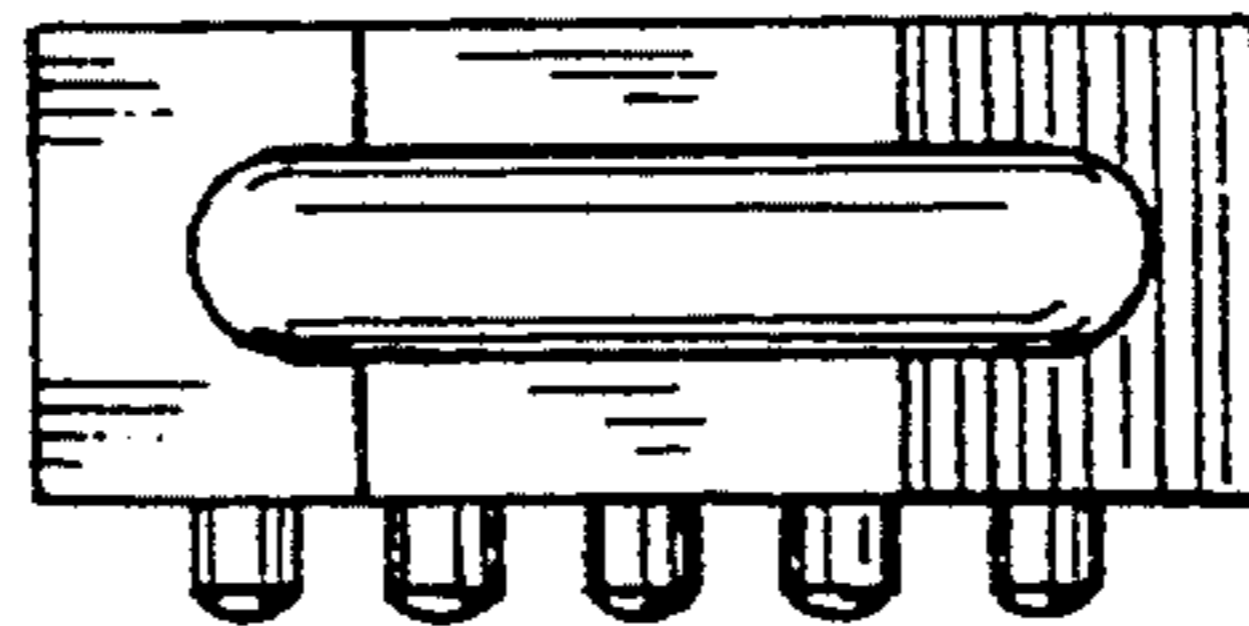

FIG. 18

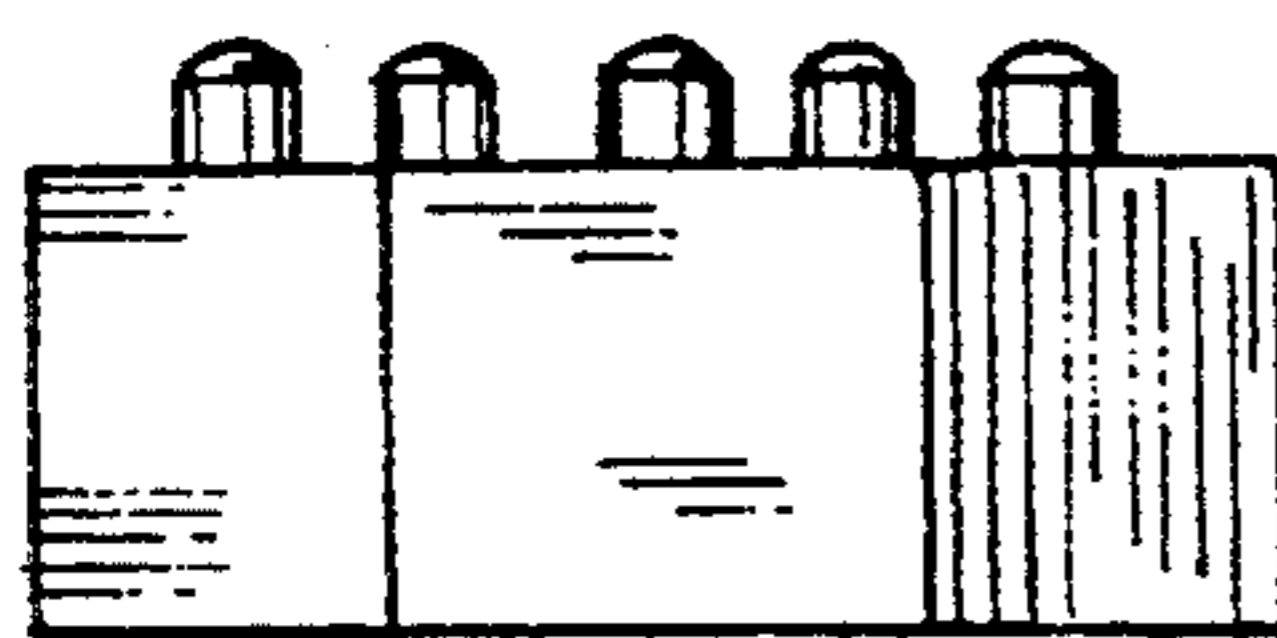

FIG. 19

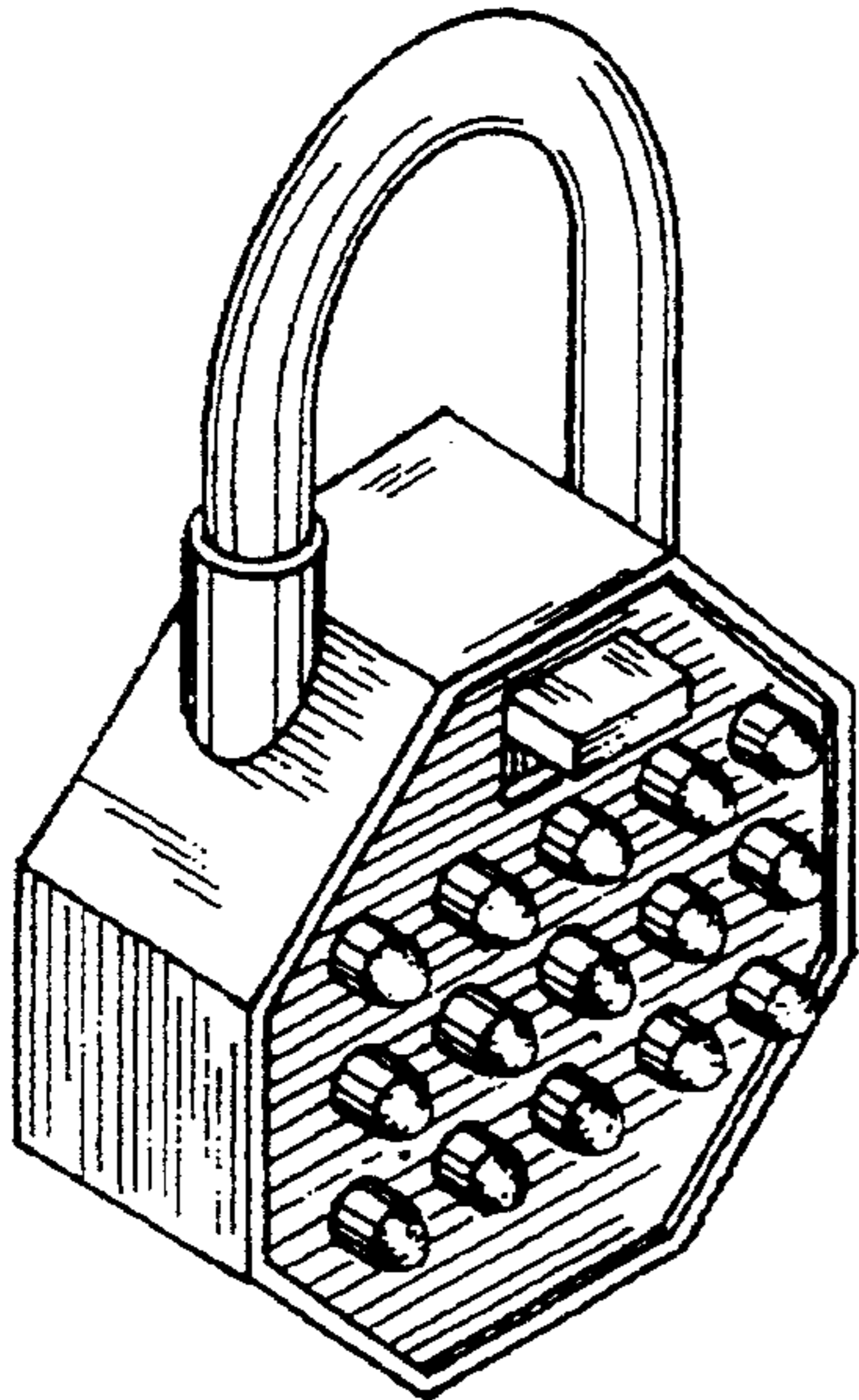

FIG. 20

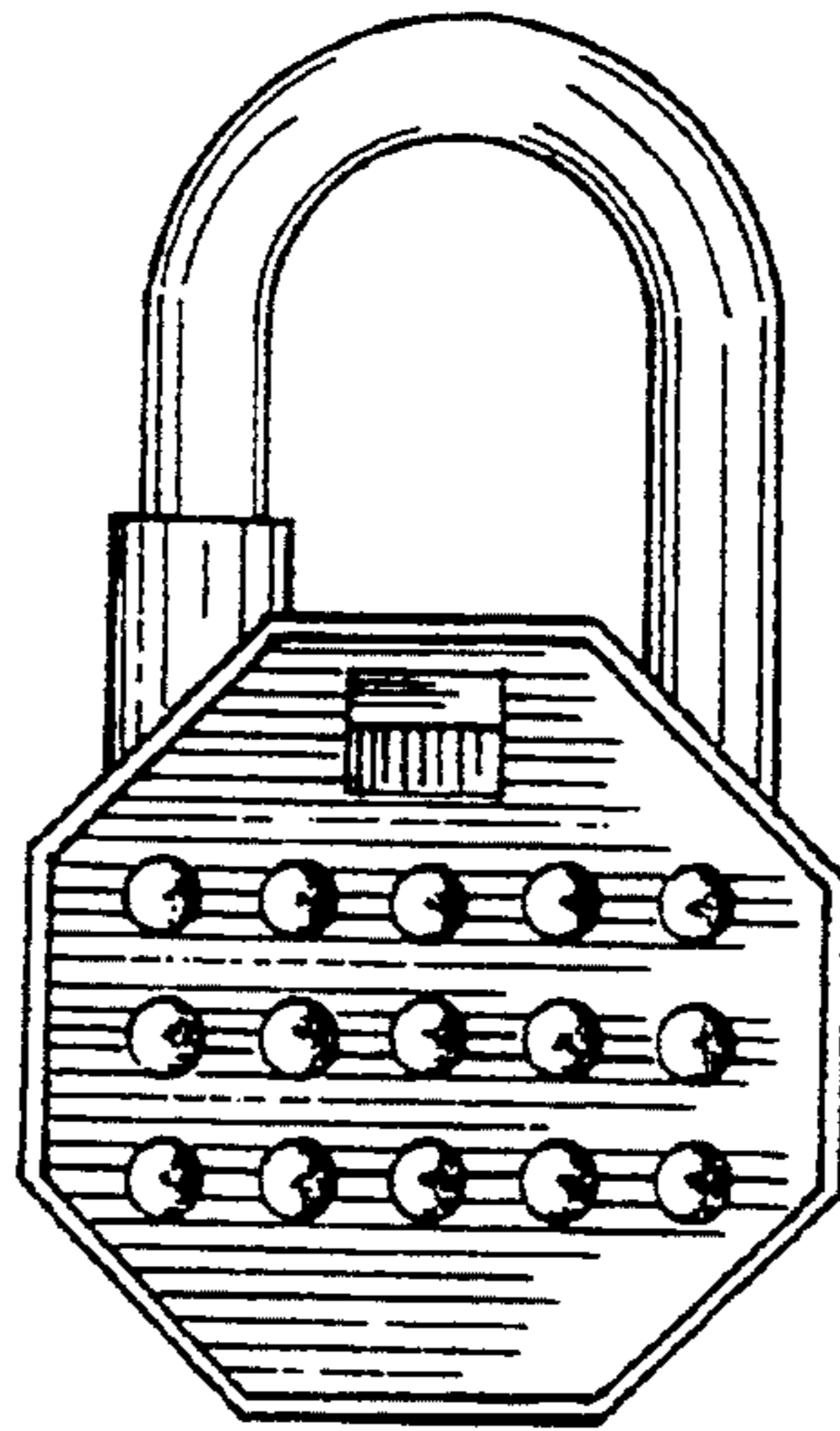

FIG. 21

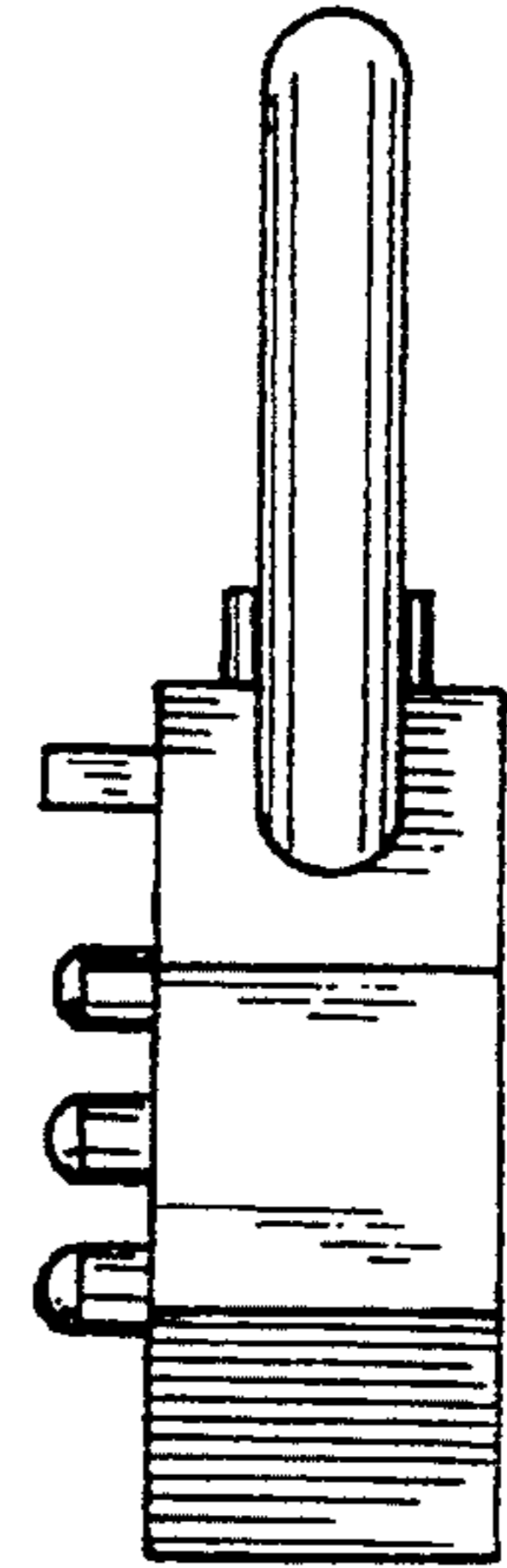

FIG. 22

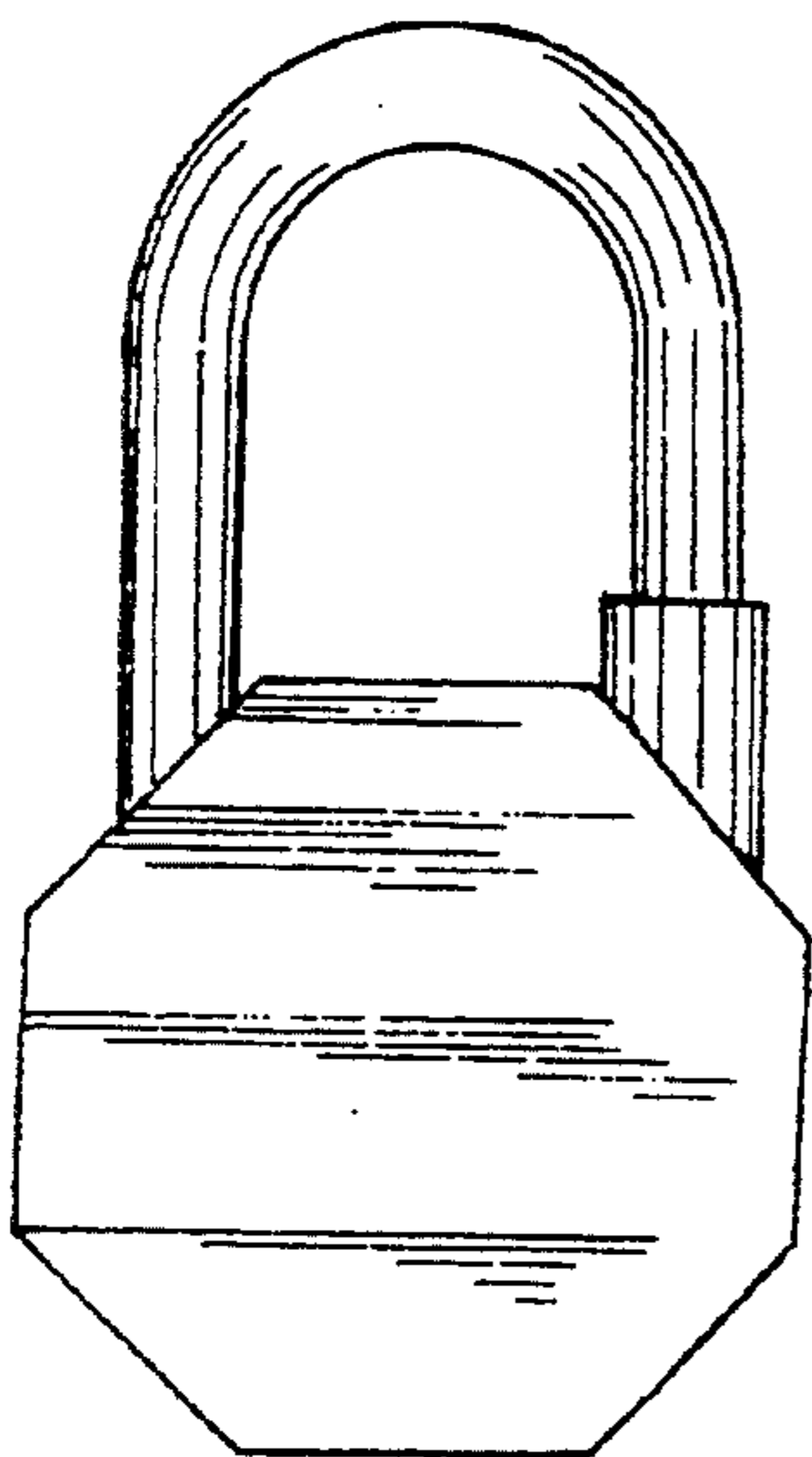

FIG. 23

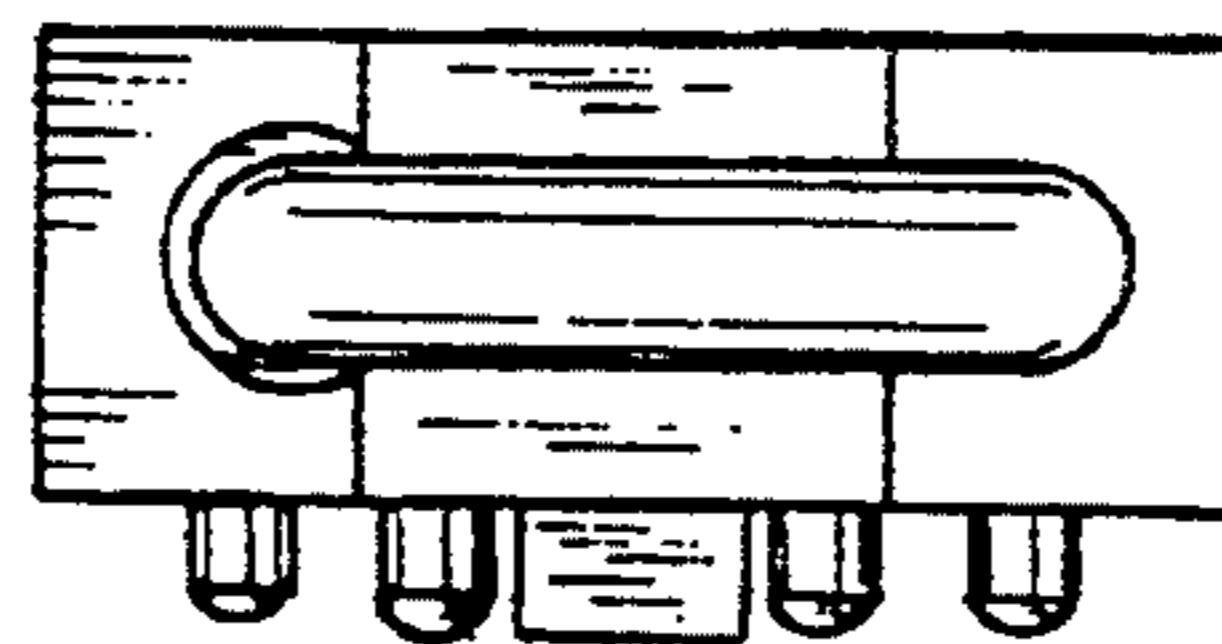

FIG. 24

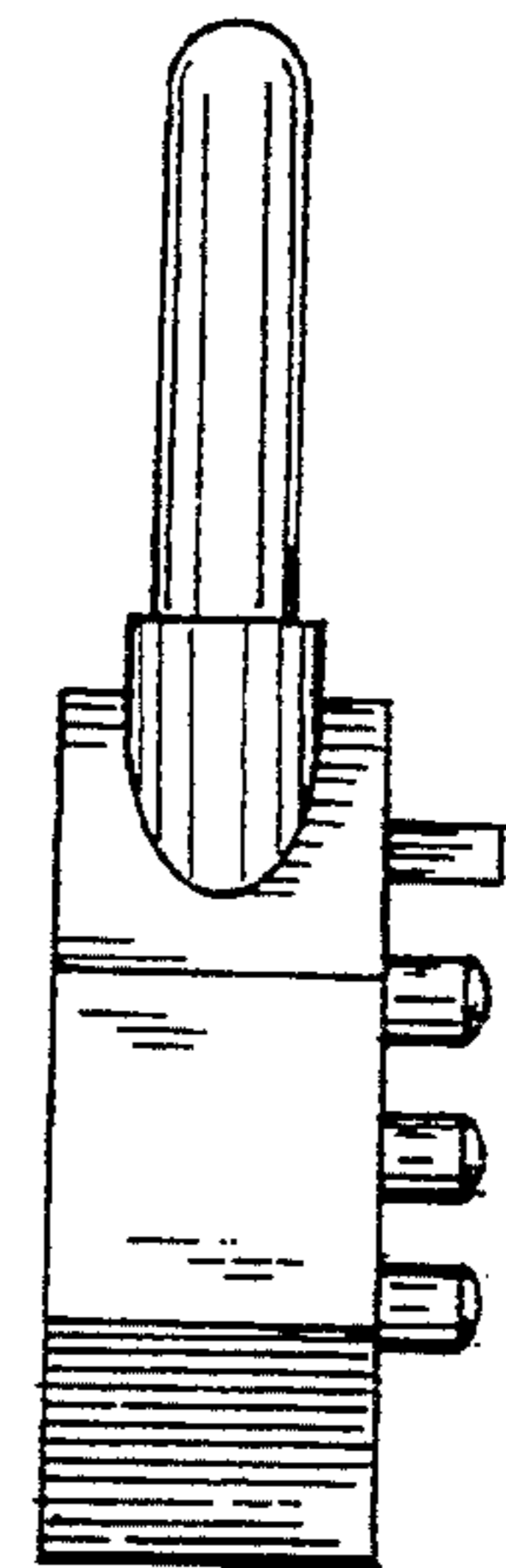

FIG. 26

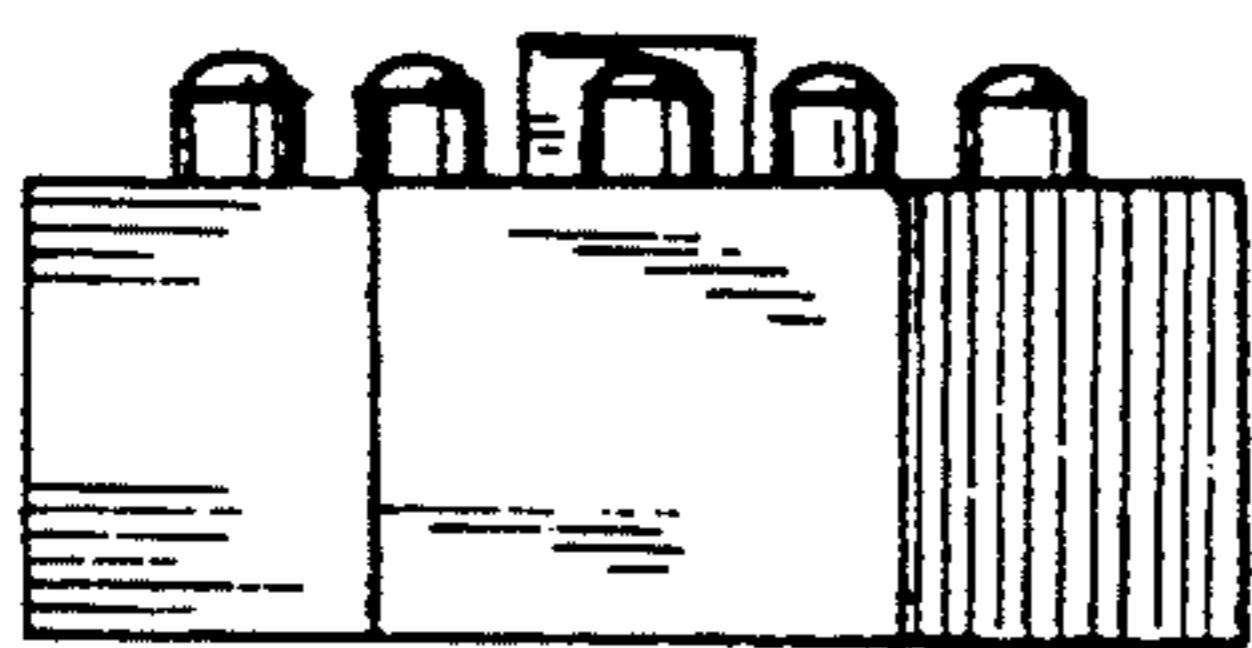

FIG. 25