



US00D360061S

**United States Patent** [19]  
**Ahn**

[11] **Patent Number: Des. 360,061**  
[45] **Date of Patent: \*\* Jul. 11, 1995**

[54] **CANDY**

[76] **Inventor: Sung A. Ahn**, 1-303, Jangmi 3rd  
Apartment, Sincheon-dong,  
Songpa-ku, Seoul, Rep. of Korea

[\*\*] **Term: 14 Years**

[21] **Appl. No.: 26,826**

[22] **Filed: Aug. 4, 1994**

[30] **Foreign Application Priority Data**

Feb. 7, 1994 [KR] Rep. of Korea ..... 1994-2409

[52] **U.S. Cl.** ..... **D1/106**

[58] **Field of Search** ..... D1/106, 126, 127, 128,  
D1/129, 199; 426/104; D26/73; D13/183;  
D11/131, 133

[56]

**References Cited**

**U.S. PATENT DOCUMENTS**

D. 225,259 11/1972 Skupien ..... D26/73  
D. 241,685 10/1976 Warren et al. .... D1/106 X  
D. 301,794 6/1989 Ballerini ..... D1/106 X

*Primary Examiner*—James M. Gandy

*Assistant Examiner*—Pam Burgess

*Attorney, Agent, or Firm*—Hoffman, Wasson & Gitle

[57]

**CLAIM**

The ornamental design for candy, as shown and described.

**DESCRIPTION**

FIG. 1 is a perspective view of the candy;  
FIG. 2 is a top view of the candy shown in FIG. 1;  
FIG. 3 is a bottom view of the candy shown in FIG. 1;  
FIG. 4 is an end view of the candy shown in FIG. 1;  
FIG. 5 is an end view opposite the end shown in FIG. 4, of the candy shown in FIG. 1;  
FIG. 6 is a side view of the candy shown in FIG. 1; and,  
FIG. 7 is a sectional view thereof, taken along line 7—7 shown in FIG. 4.

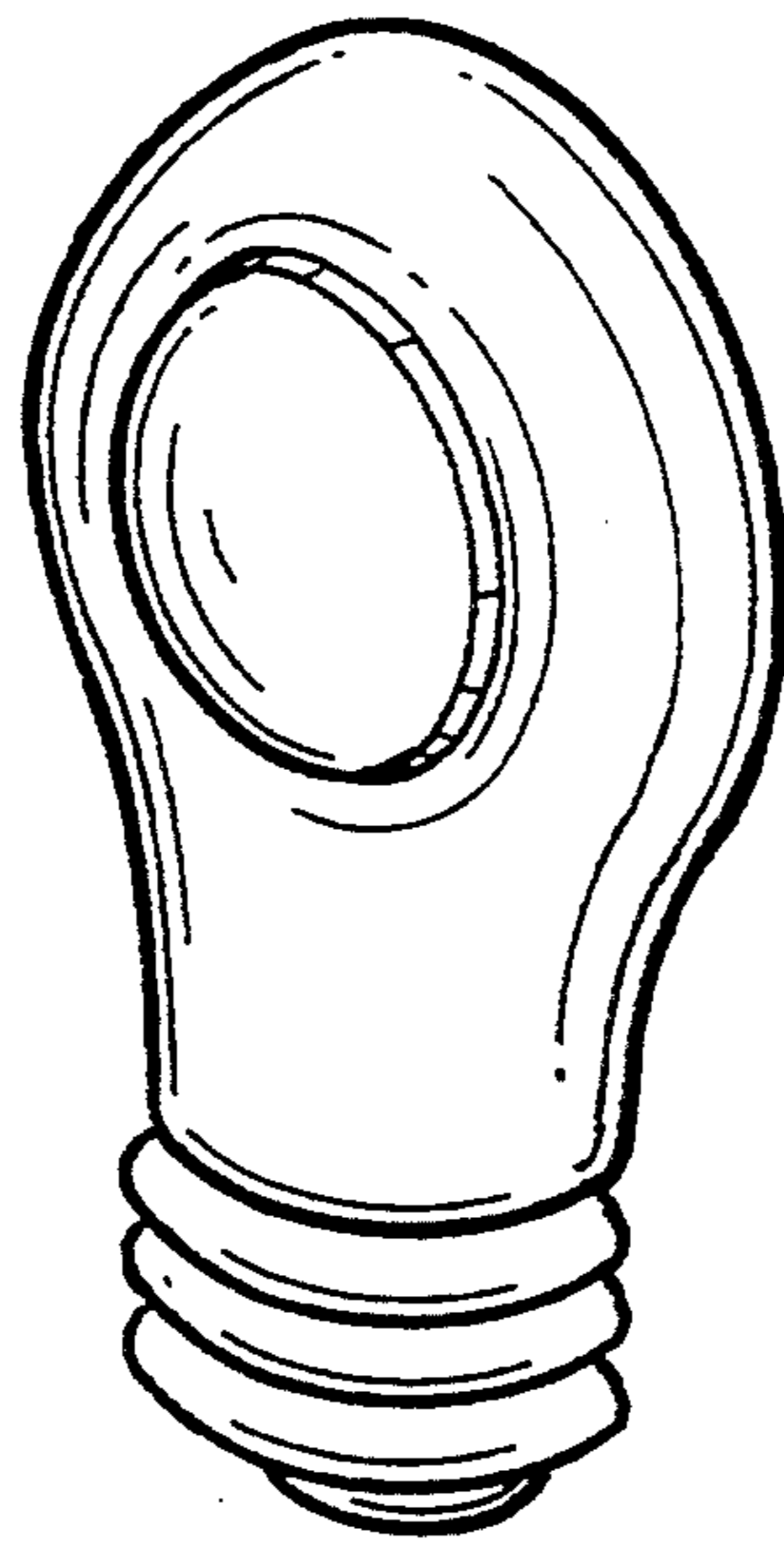

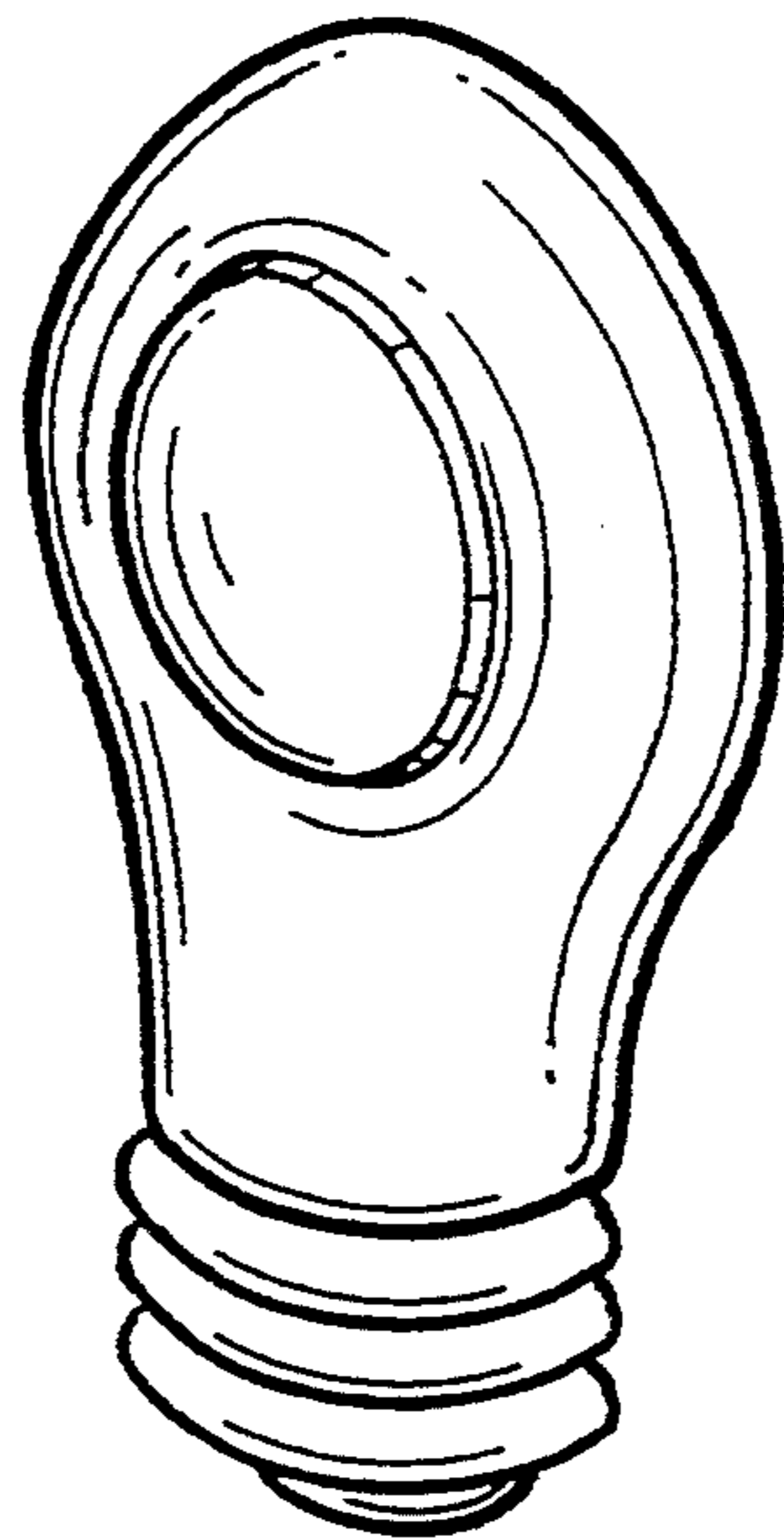

**FIG. 1**

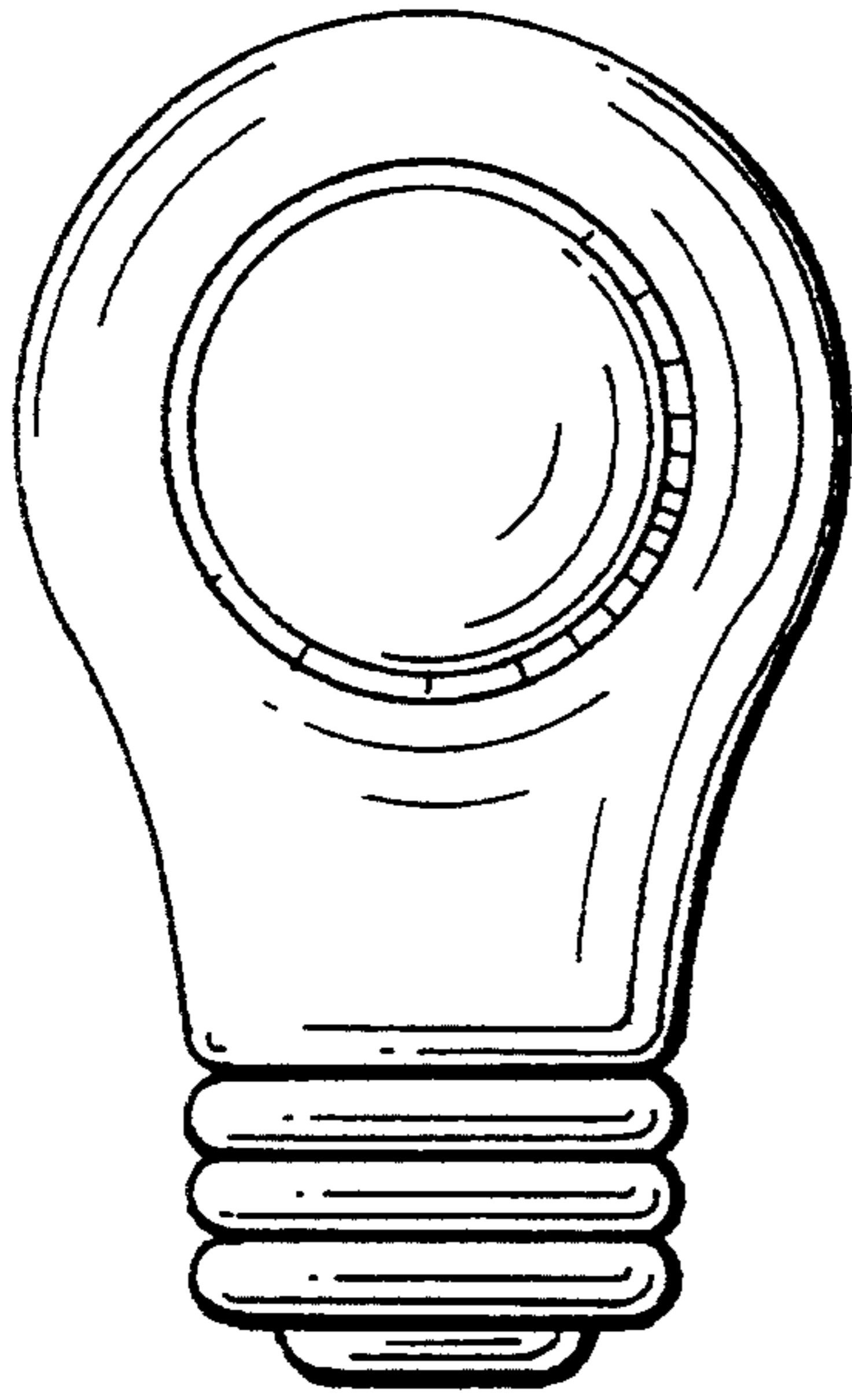

FIG. 2

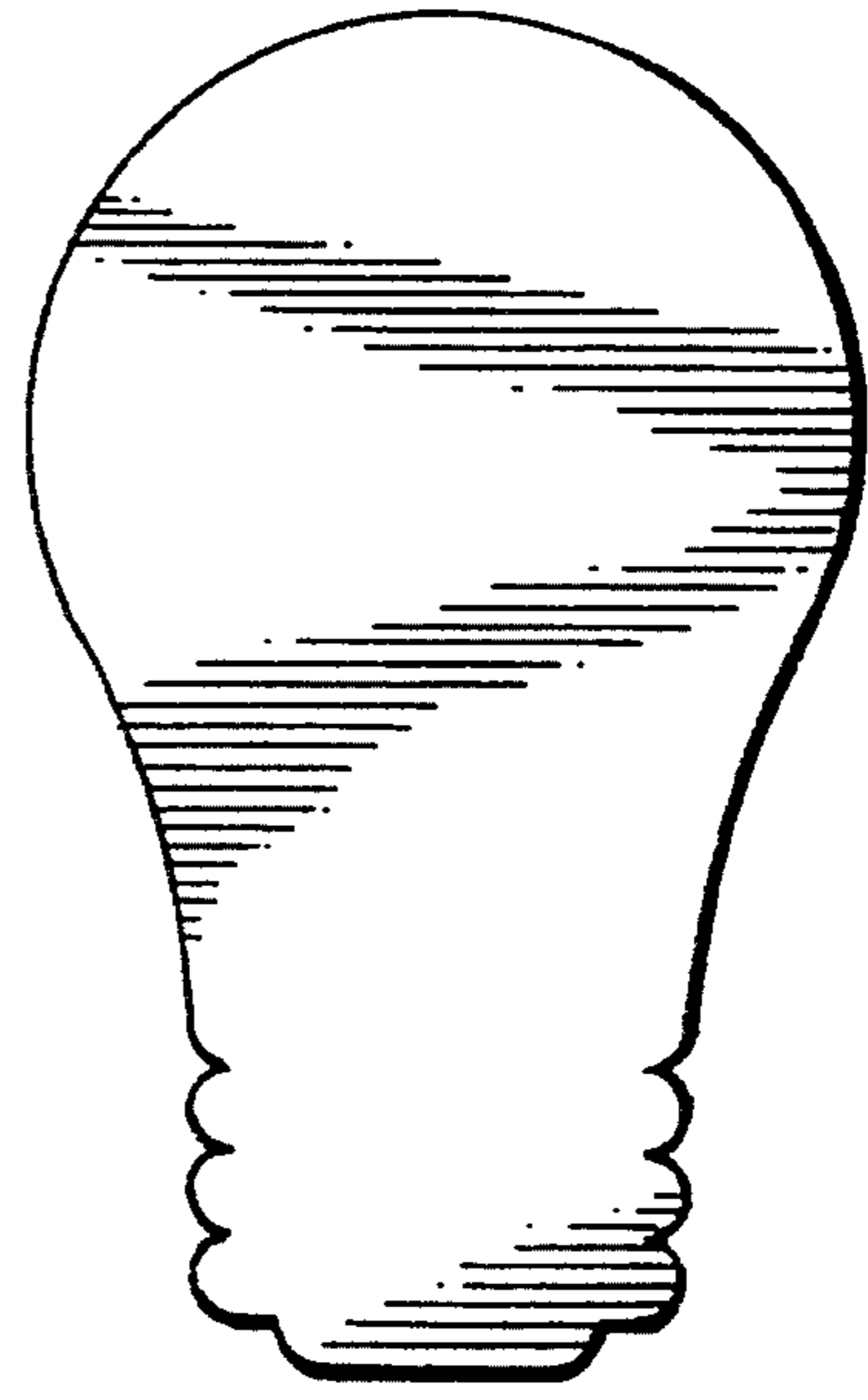

FIG. 3

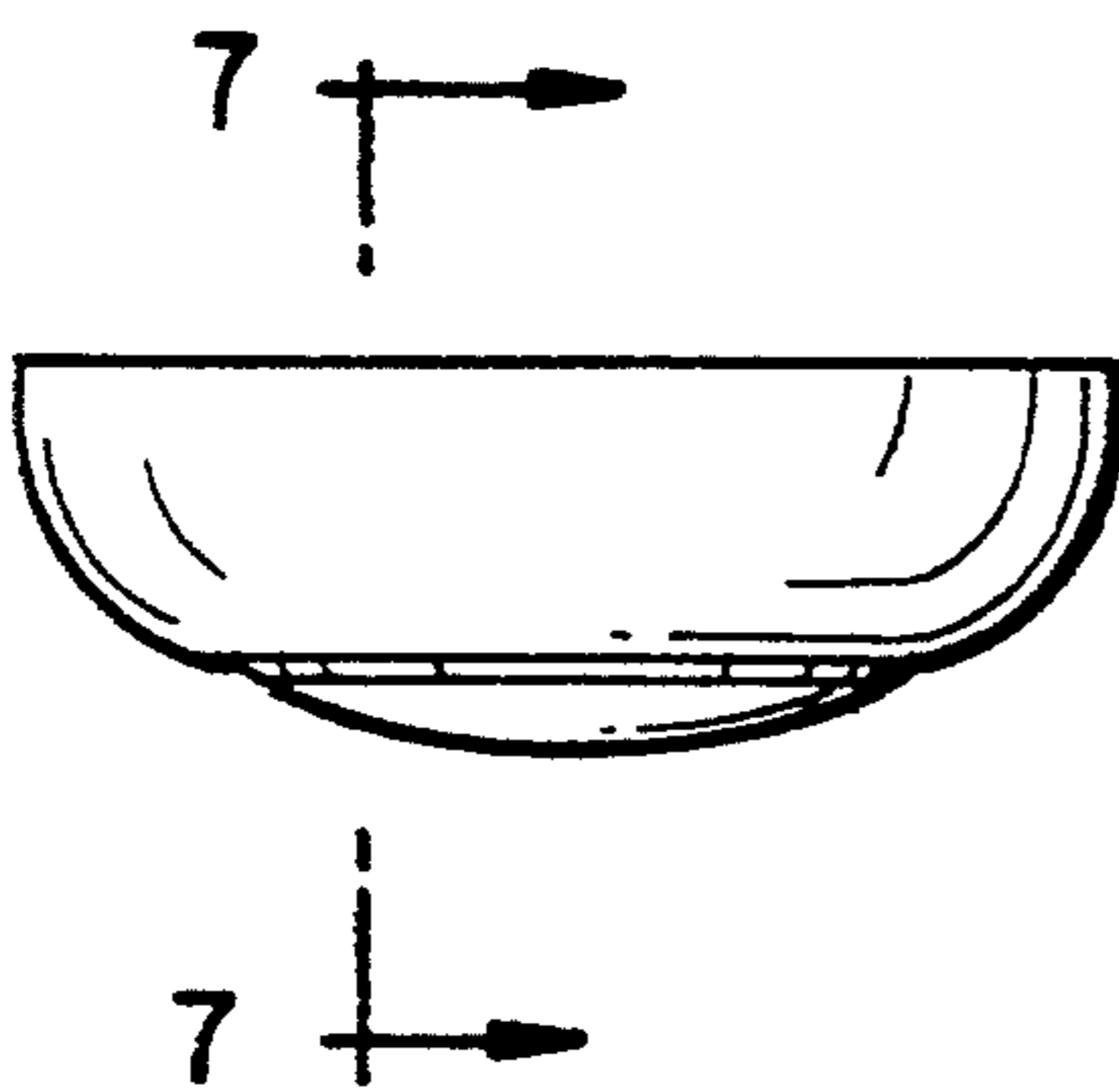

FIG. 4

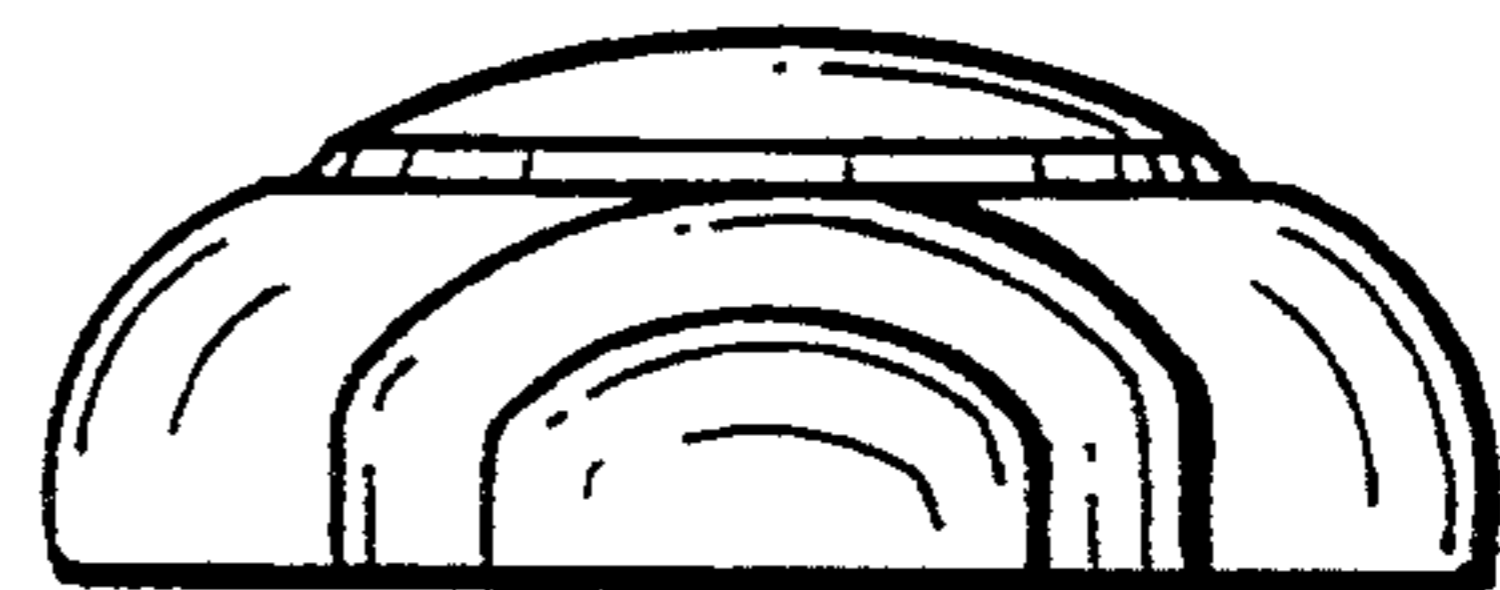

FIG. 5



FIG. 6

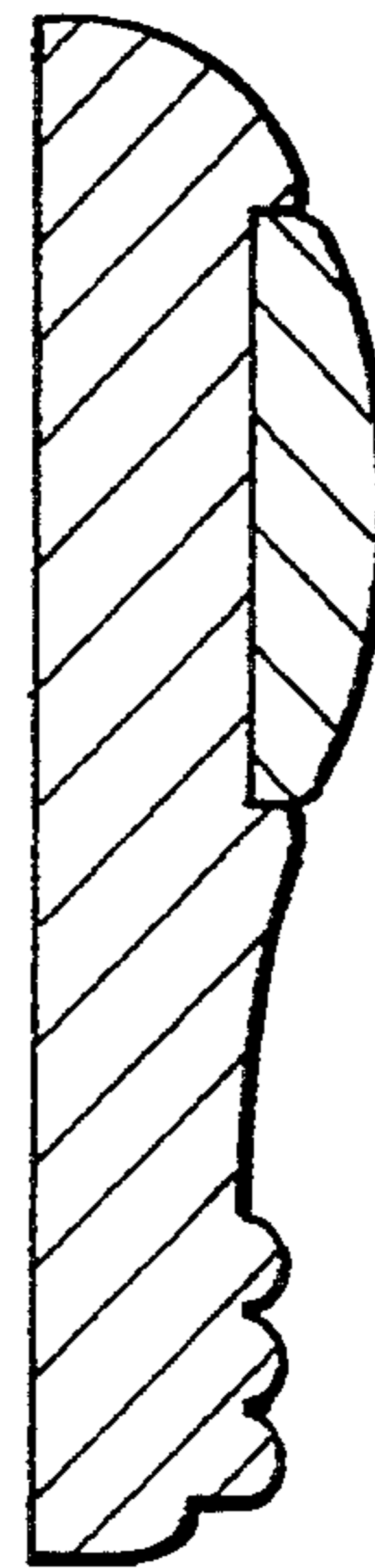

FIG. 7