



US00D359943S

United States Patent [19]

[11] Patent Number: **Des. 359,943**

Cucheran et al.

[45] Date of Patent: **** Jul. 4, 1995**

[54] **LUGGAGE RACK**

[75] Inventors: **John S. Cucheran**, Lake Orion; **Jon D. Sparham**, Waterford, both of Mich.

[73] Assignee: **JAC Products, Inc.**, Ann Arbor, Mich.

[**] Term: **14 Years**

[21] Appl. No.: **12,982**

[22] Filed: **Sep. 15, 1993**

[52] U.S. Cl. **D12/414**

[58] Field of Search **D12/414; 224/309, 316, 224/325, 317, 322-324, 326-329, 331, 42.1, 42.2**

[56] **References Cited**

U.S. PATENT DOCUMENTS

D. 282,155	1/1986	Bott	D12/414
D. 283,117	3/1986	Bott	D12/414
D. 300,018	2/1989	Bott	D12/414
D. 320,373	10/1991	Sparham et al.	D12/414
D. 333,808	3/1993	Cucheran	D12/414
D. 334,373	3/1993	Cucheran	D12/414
4,269,339	5/1981	Bott	224/325
4,426,028	1/1984	Bott	224/325
5,004,139	4/1991	Storm et al.	224/309
5,016,799	5/1991	Stapleton	224/309

Primary Examiner—Susan J. Lucas

Assistant Examiner—M. Brown

Attorney, Agent, or Firm—Harness, Dickey & Pierce

[57] **CLAIM**

The ornamental design for a luggage rack, as shown and described.

DESCRIPTION

FIG. 1 is a perspective view of a luggage rack showing our new design, the broken lines are shown for illustrative purposes only and form no part of the claimed design;

FIG. 2 is a top view of the luggage rack design of FIG. 1;

FIG. 3 is a left side view of the luggage rack of FIG. 1;

FIG. 4 is a front view of the luggage rack of FIG. 1;

FIG. 5 is a rear view of a luggage rack of FIG. 1;

FIG. 6 is an enlarged left side view of one of the front stanchions of the luggage rack shown in FIG. 1;

FIG. 7 is a top view of the stanchion of FIG. 6;

FIG. 8 is a right side view of the stanchion of FIG. 6;

FIG. 9 is a rear view of the stanchion of FIG. 6;

FIG. 10 is a front view of the stanchion of FIG. 6;

FIG. 11 is an enlarged left side view of the rear stanchion of FIG. 3;

FIG. 12 is a top view of the stanchion of FIG. 11;

FIG. 13 is a left side view of the stanchion of FIG. 11;

FIG. 14 is a rear view of the stanchion of FIG. 11; and,

FIG. 15 is a front view of the stanchion of FIG. 11.

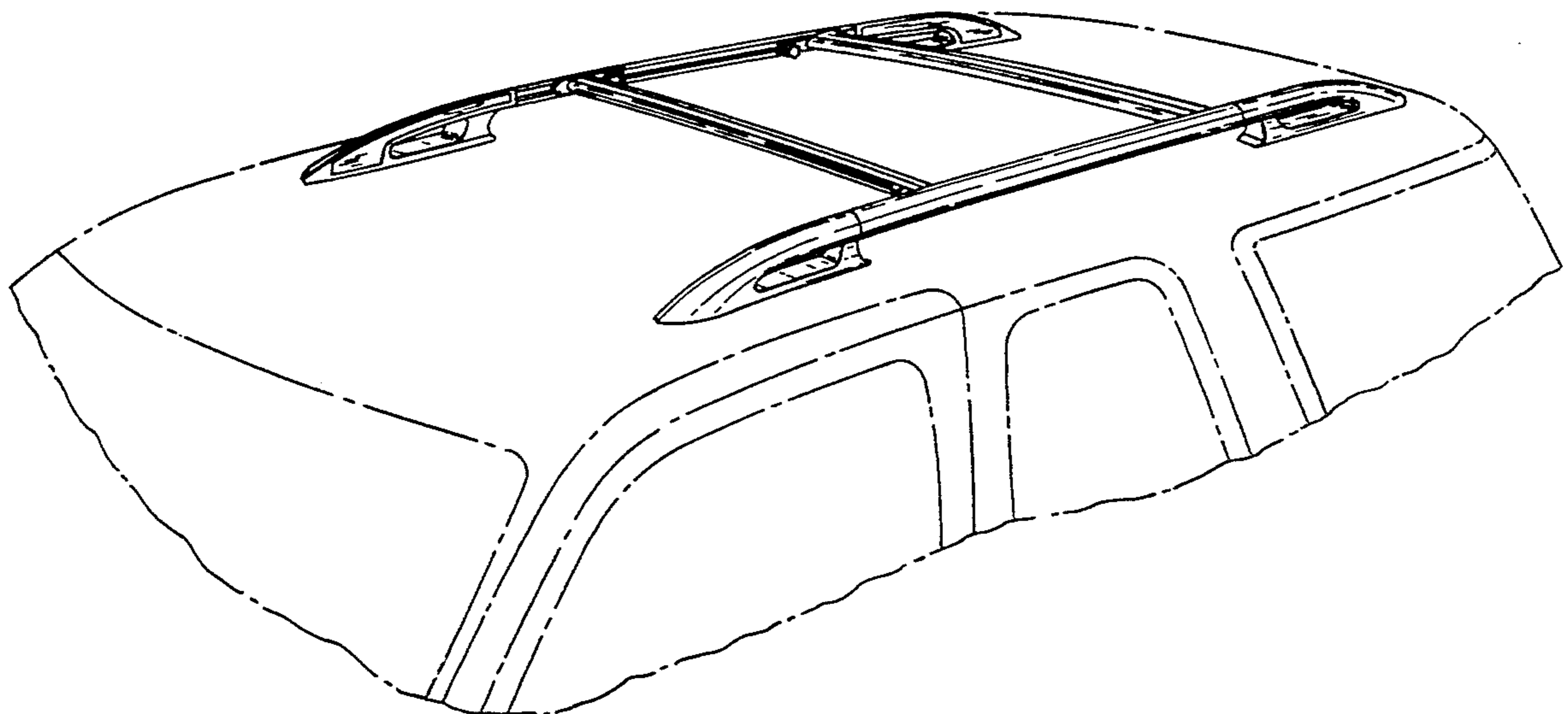

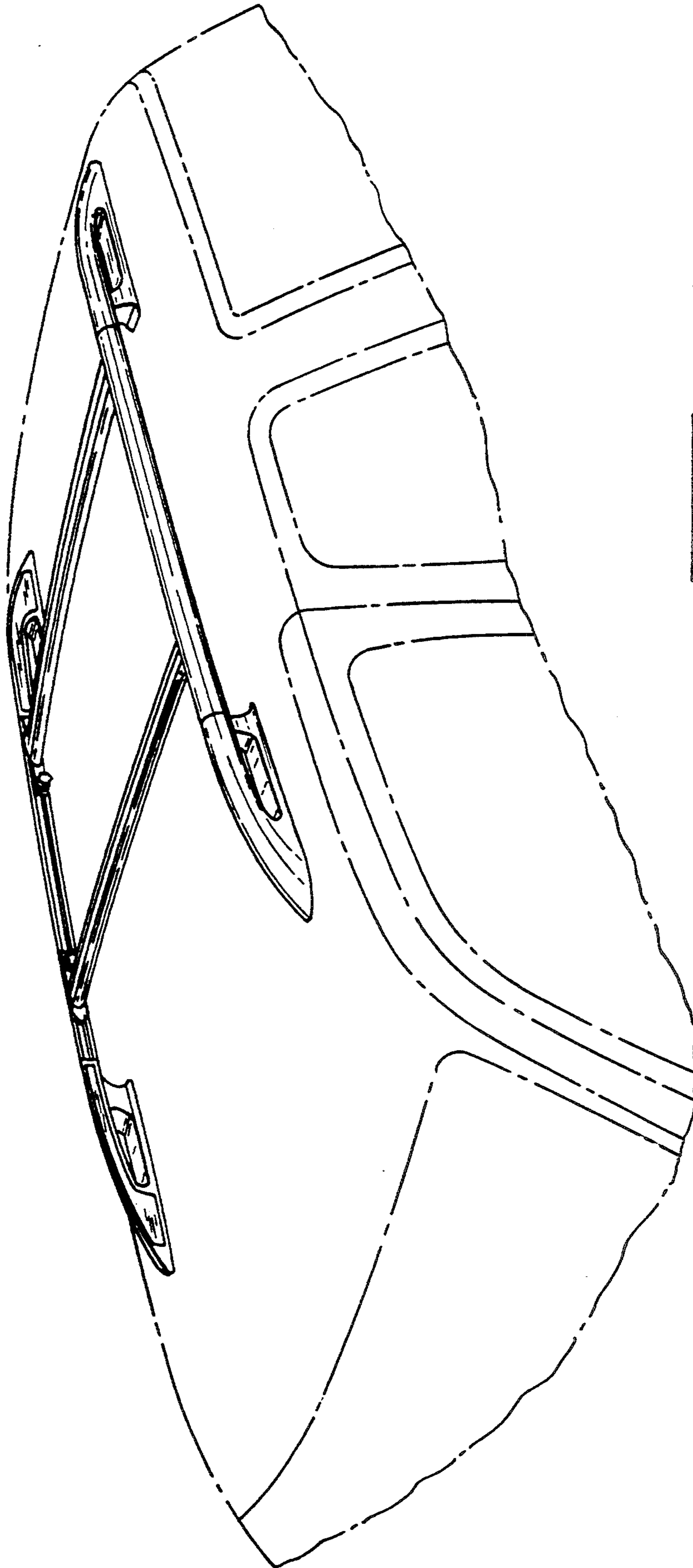

FIG. 1.

FIG. 2.

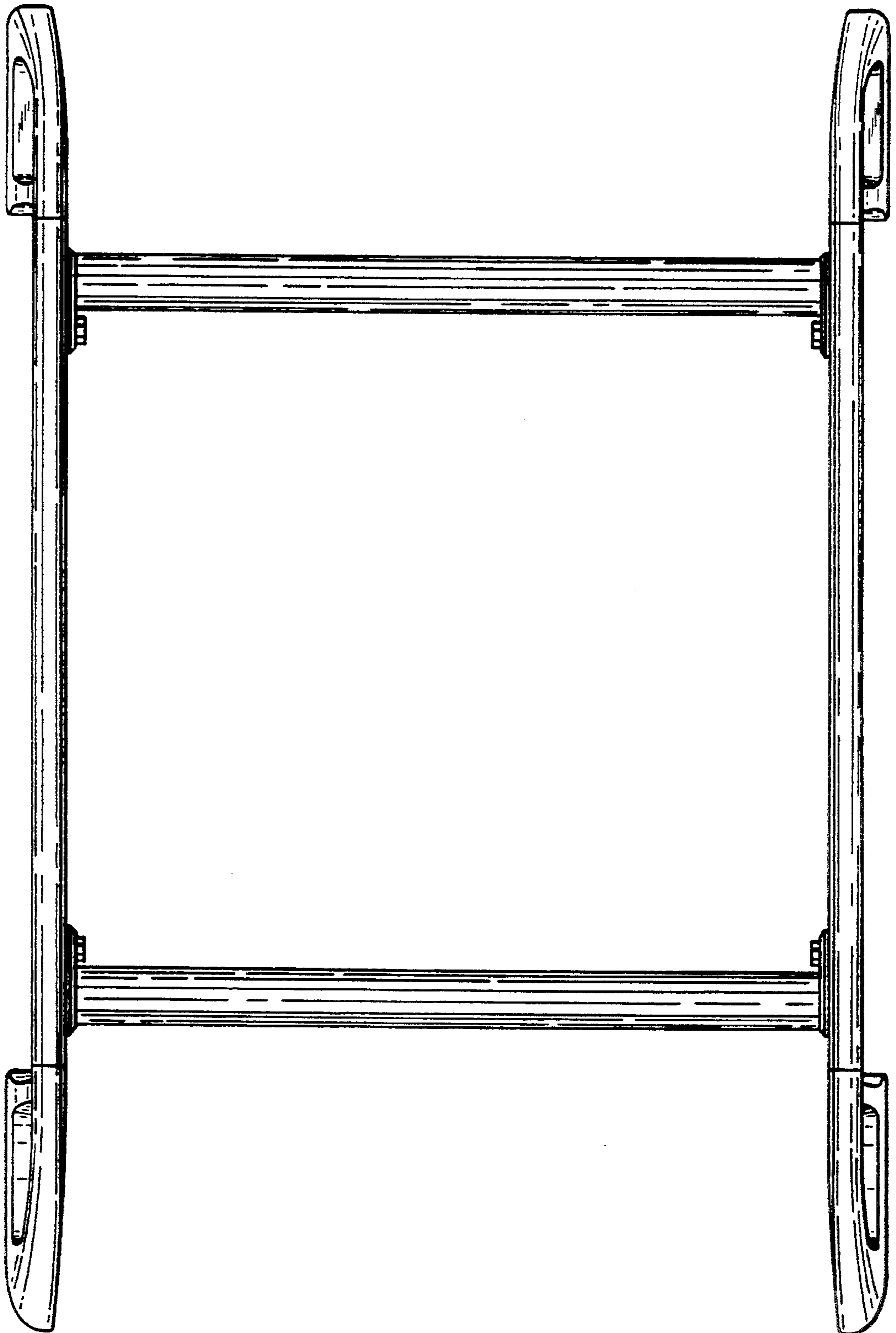



FIG. 2.



FIG. 3.



FIG. 4.

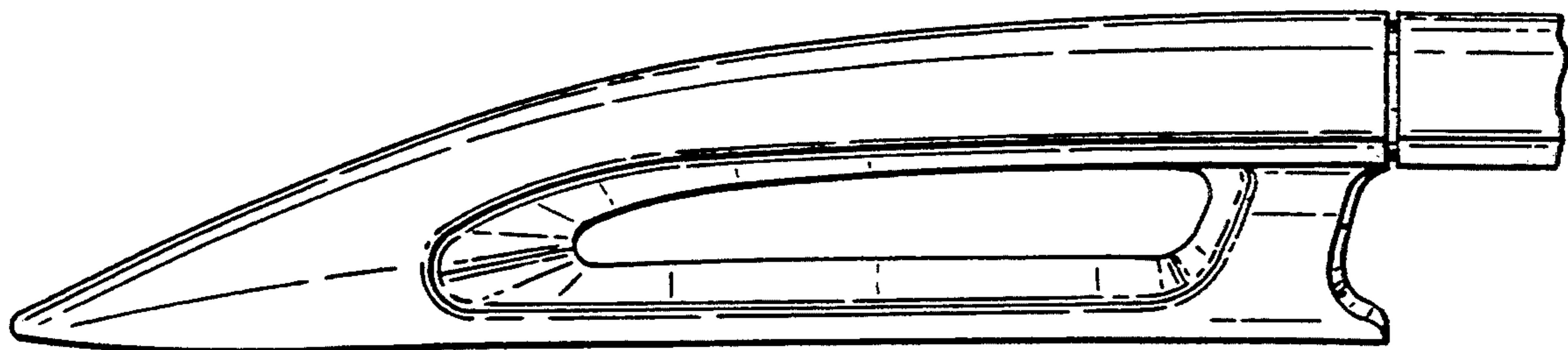

FIG. 6.

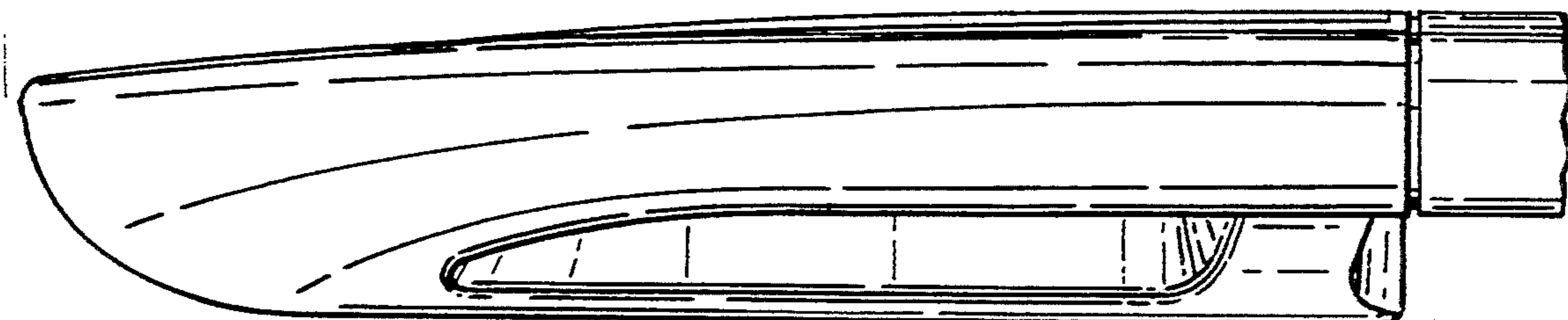

FIG. 7.

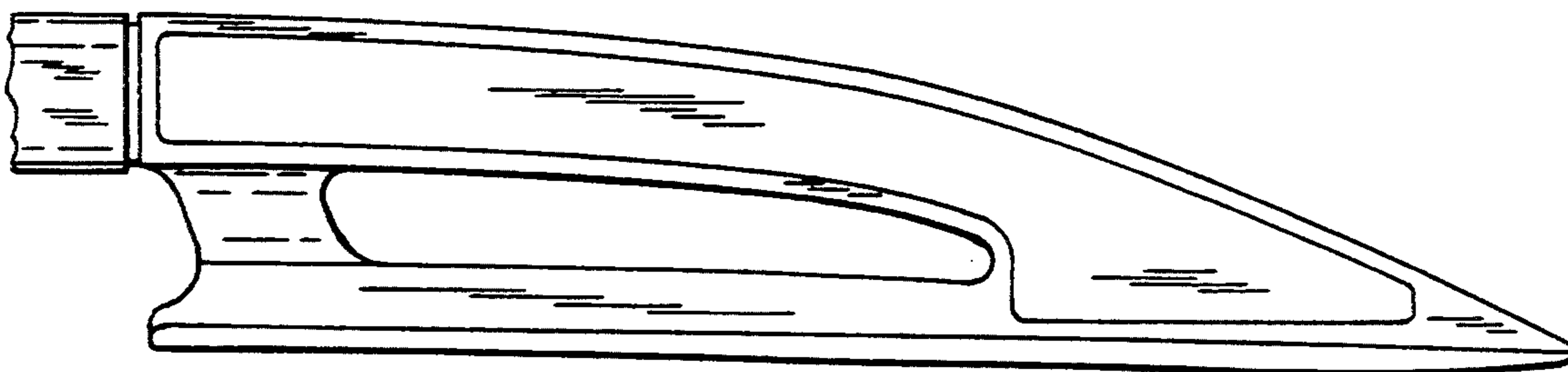

FIG. 8.

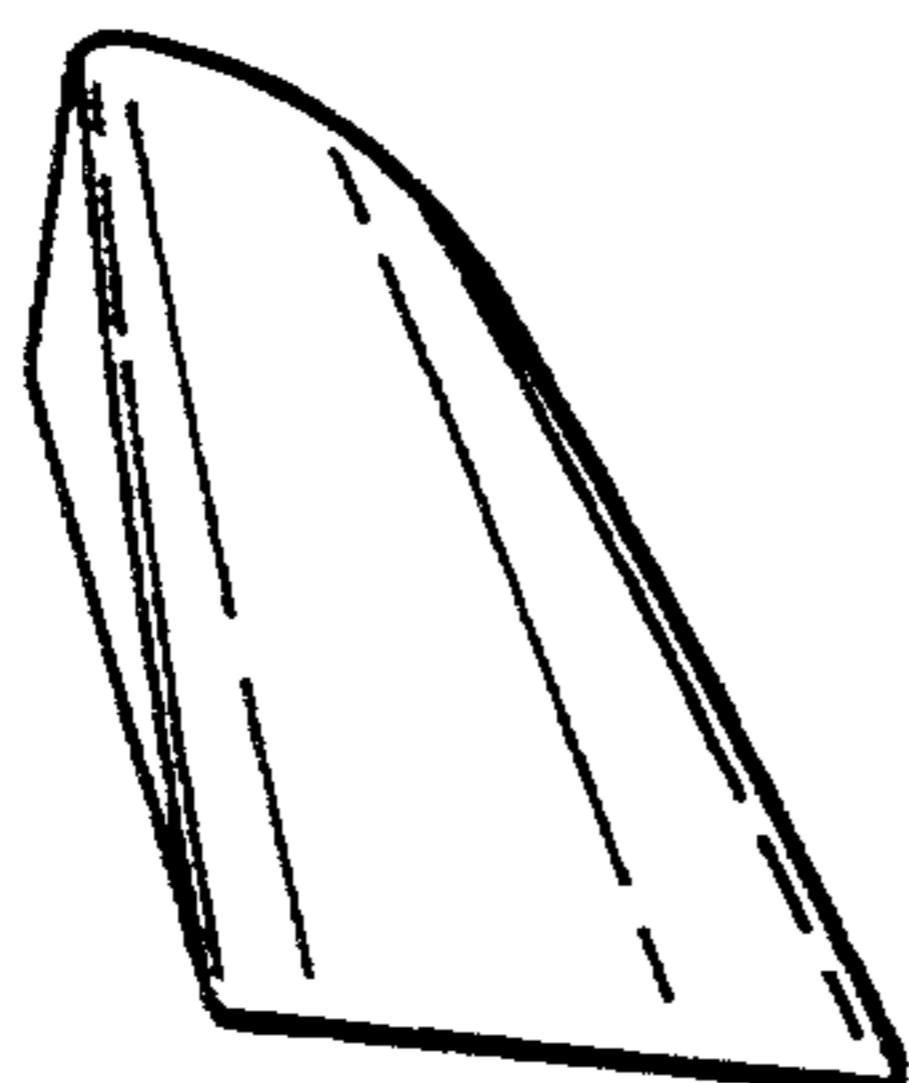

FIG. 9.

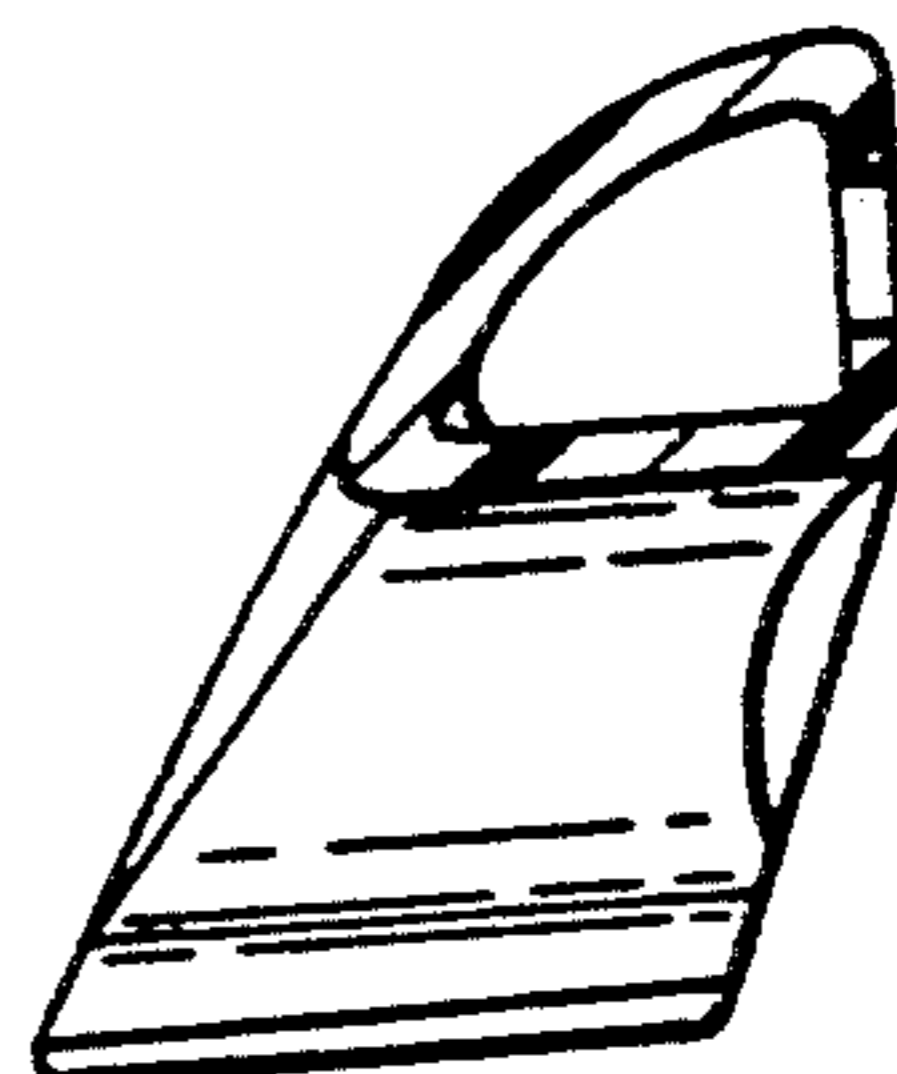

FIG. 10.

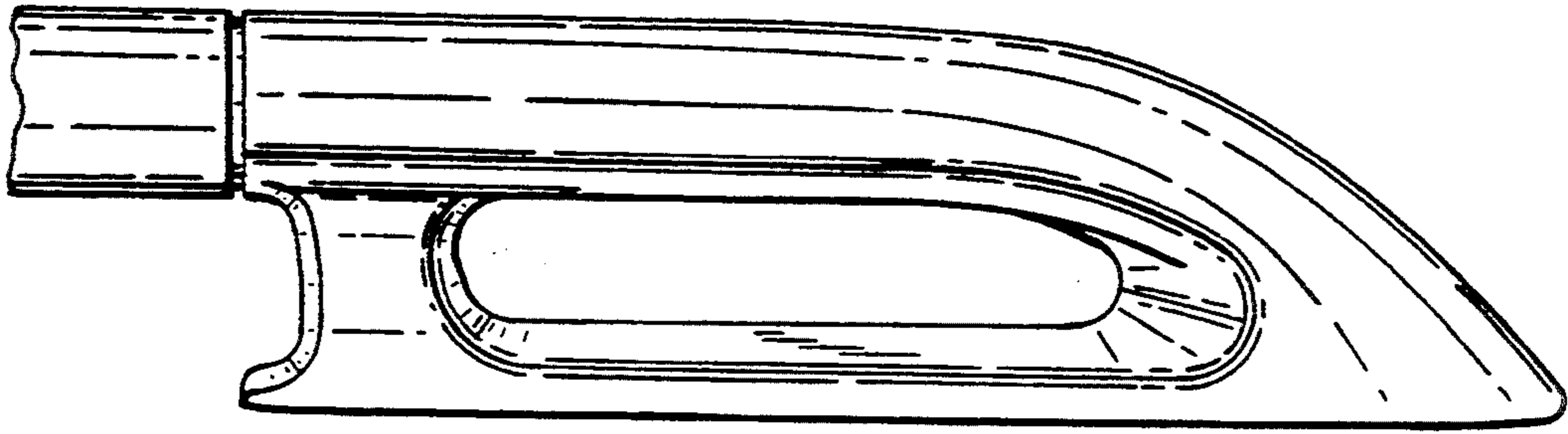

FIG. 11.

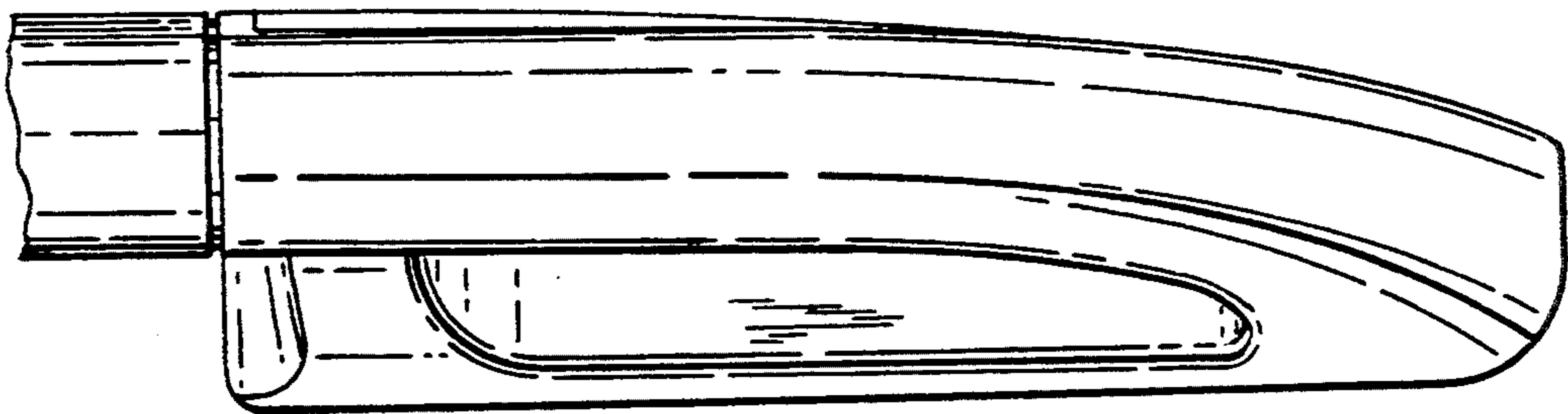

FIG. 12.

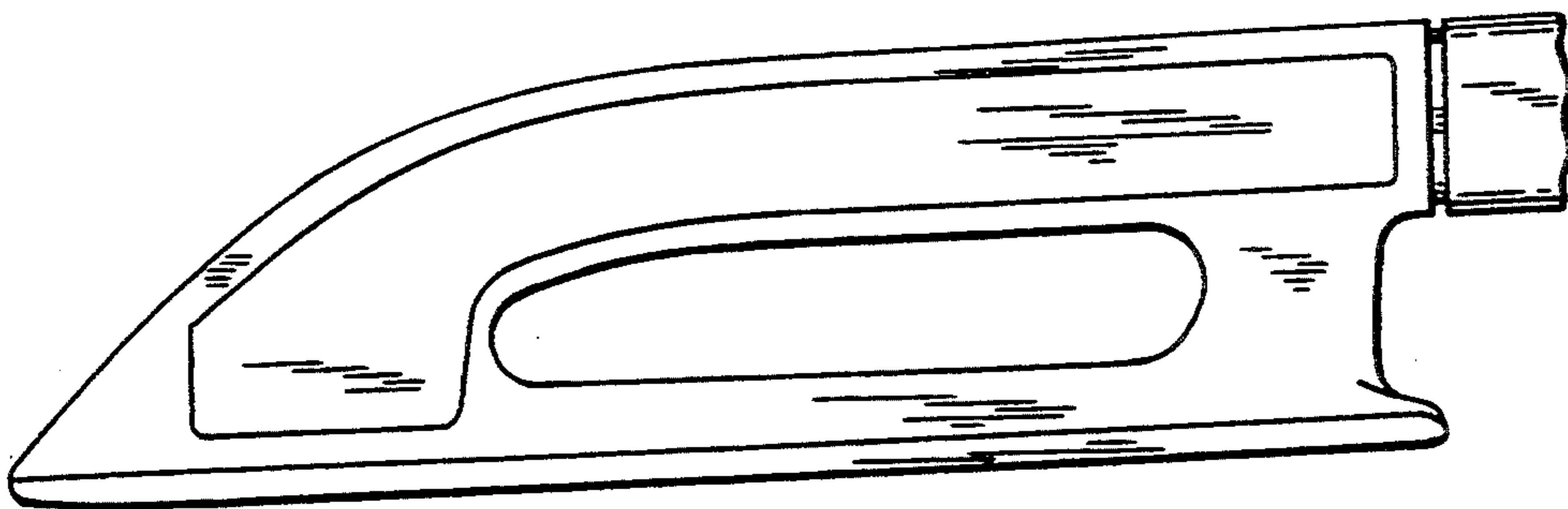

FIG. 13.

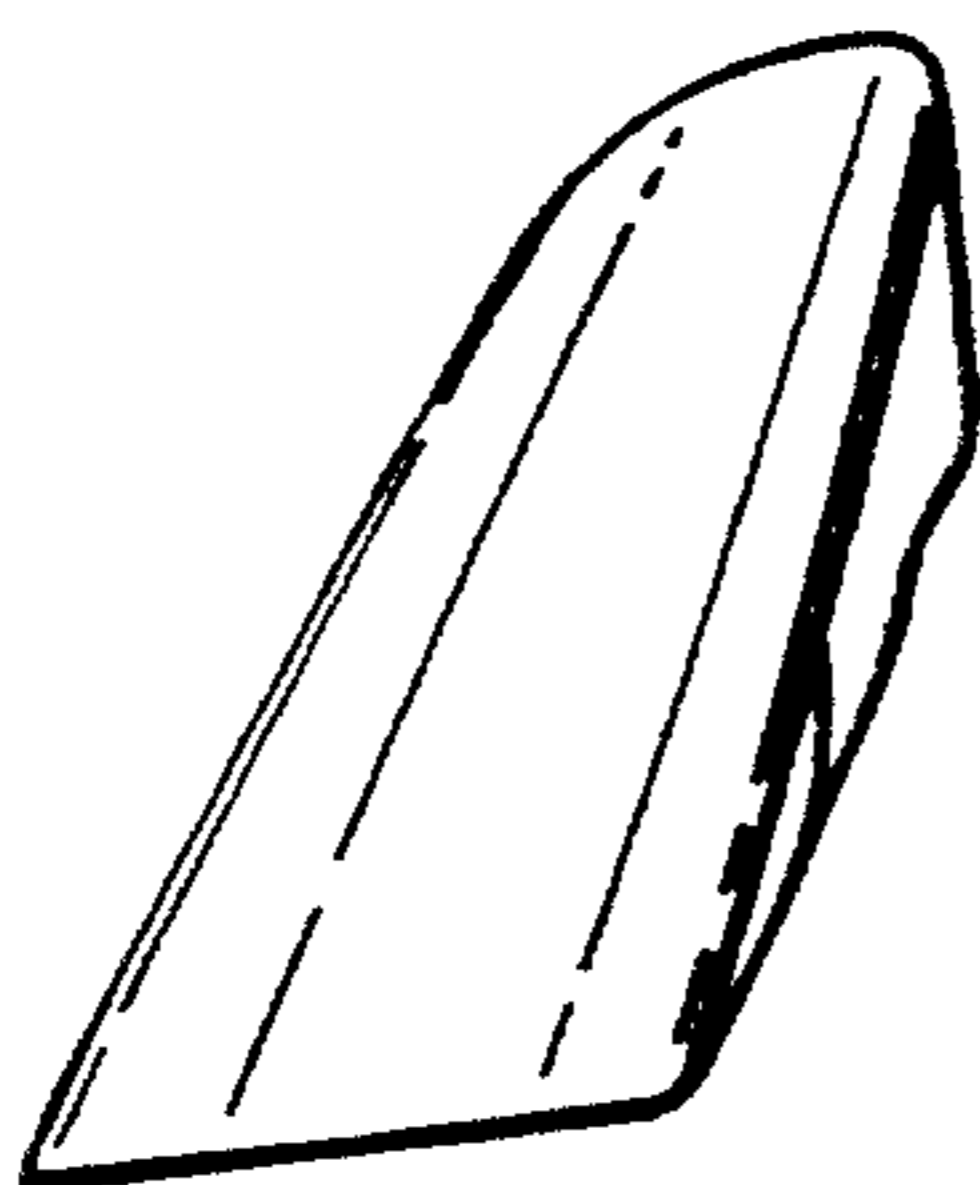

FIG. 14.

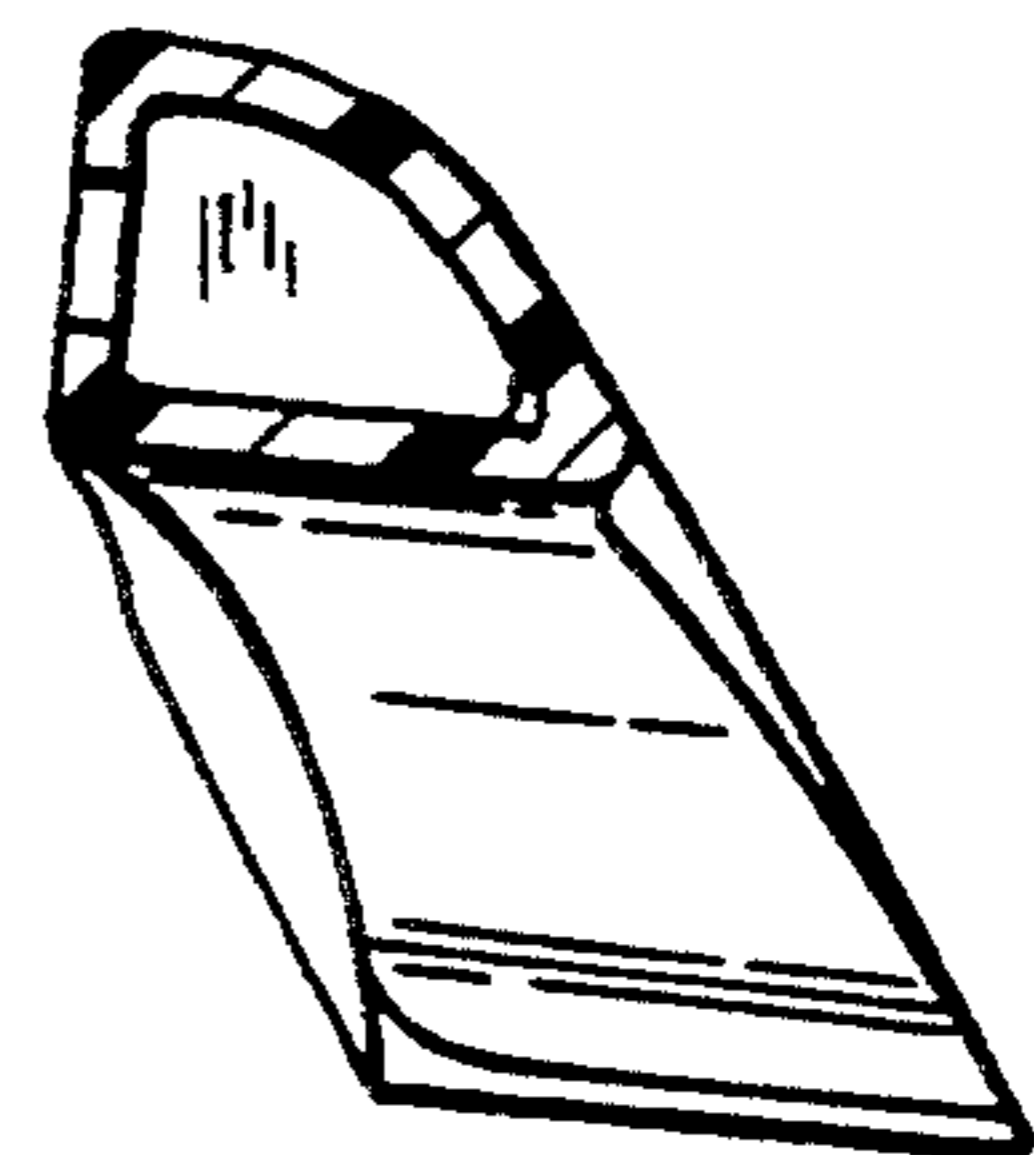

FIG. 15.