



US00D359818S

**United States Patent** [19]  
**Ichikawa**

[11] **Patent Number: Des. 359,818**  
[45] **Date of Patent: \*\* Jun. 27, 1995**

[54] **LIGHTER**

2,986,027 5/1961 Lockwood ..... 431/151 X

[75] Inventor: **Makoto Ichikawa, Sakurashinmachi, Japan**

**FOREIGN PATENT DOCUMENTS**

497496 8/1950 Belgium ..... 431/152

[73] Assignee: **Modern Royal Co., Ltd., Tokyo, Japan**

*Primary Examiner*—Louis S. Zarfes  
*Assistant Examiner*—Monica A. Hannon  
*Attorney, Agent, or Firm*—Oblon, Spivak, McClelland, Maier & Neustadt

[\*\*] Term: **14 Years**

[21] Appl. No.: **25,793**

[57] **CLAIM**

[22] Filed: **Jul. 12, 1994**

The ornamental design for a lighter, as shown and described.

[30] **Foreign Application Priority Data**

**DESCRIPTION**

Apr. 28, 1994 [JP] Japan ..... 6-12120

[52] U.S. Cl. .... **D27/157; D27/141; D27/157**

[58] **Field of Search** ..... D27/101, 102, 103, 139, D27/141, 142, 143, 144, 147, 154, 155, 156, 157, 158, 159, 160; 131/173, 194, 270, 329, 336, 360, 361; 431/125, 129-152, 343

FIG. 1 is a right front perspective view of a lighter, with the substantially half lower portion thereof made transparent, showing my new design;  
FIG. 2 is a front elevational view thereof;  
FIG. 3 is a rear elevational view thereof;  
FIG. 4 is a left side elevational view thereof;  
FIG. 5 is a right side elevational view thereof;  
FIG. 6 is a top plan view thereof;  
FIG. 7 is a bottom plan view thereof;  
FIG. 8 is a front elevational view thereof with a lid in open position; and,  
FIG. 9 is a top plan view thereof with the lid in open position.

[56] **References Cited**

**U.S. PATENT DOCUMENTS**

2,529,094 11/1950 Miller ..... 431/152 X  
2,881,608 4/1959 Lockwood ..... 431/151 X  
2,986,026 5/1961 Lockwood ..... 431/151 X

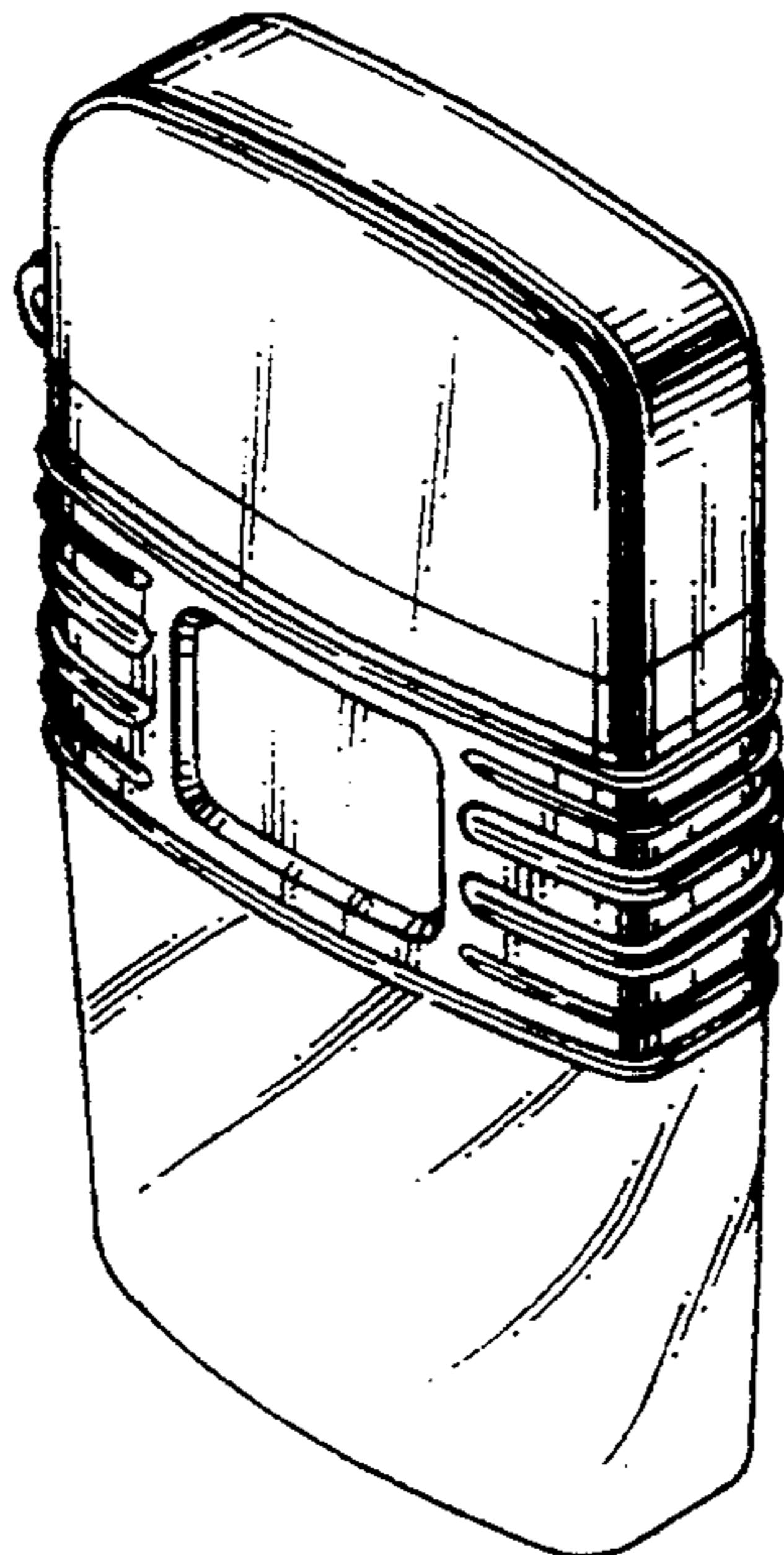

FIG. 1

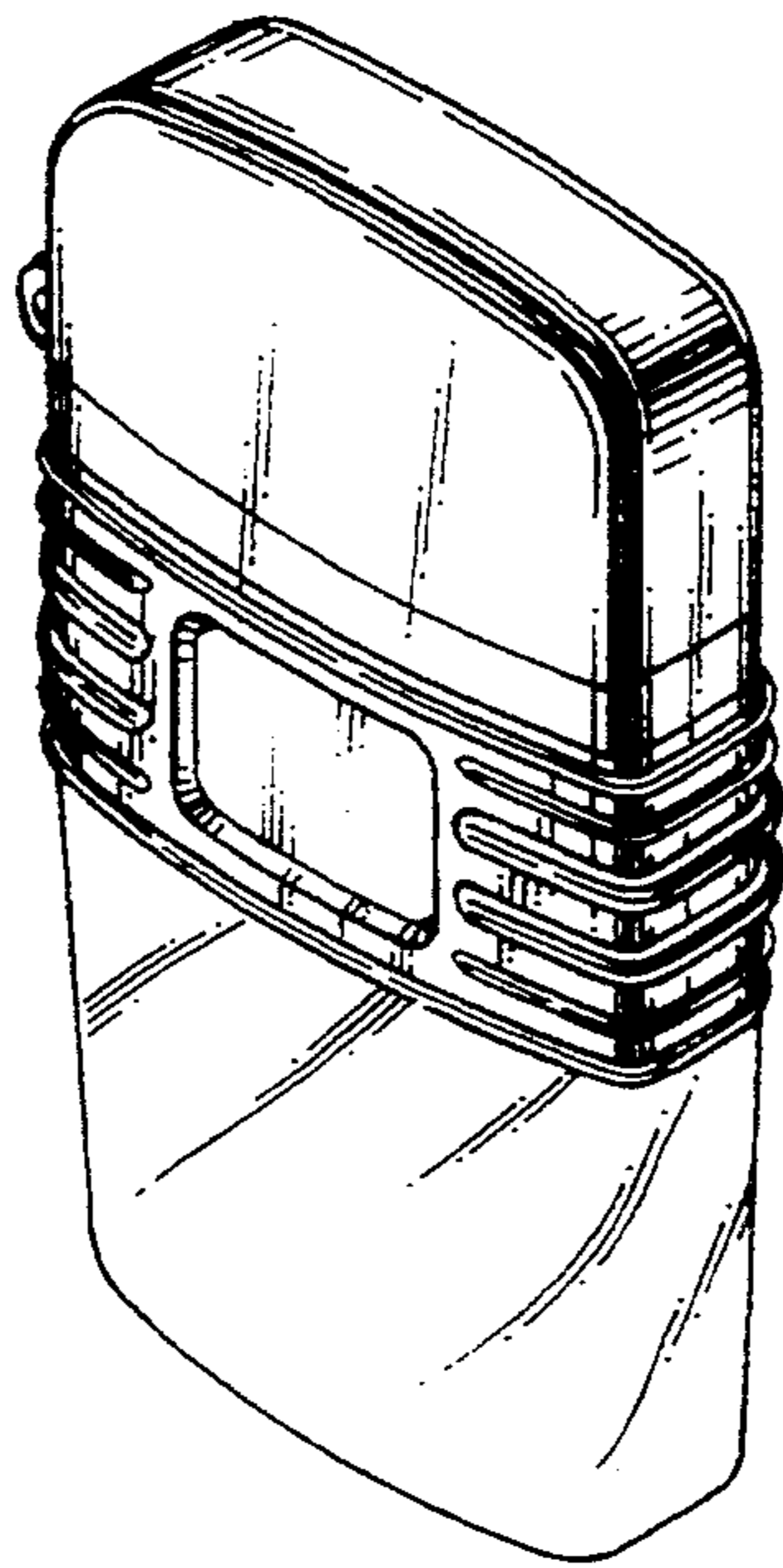

FIG. 2

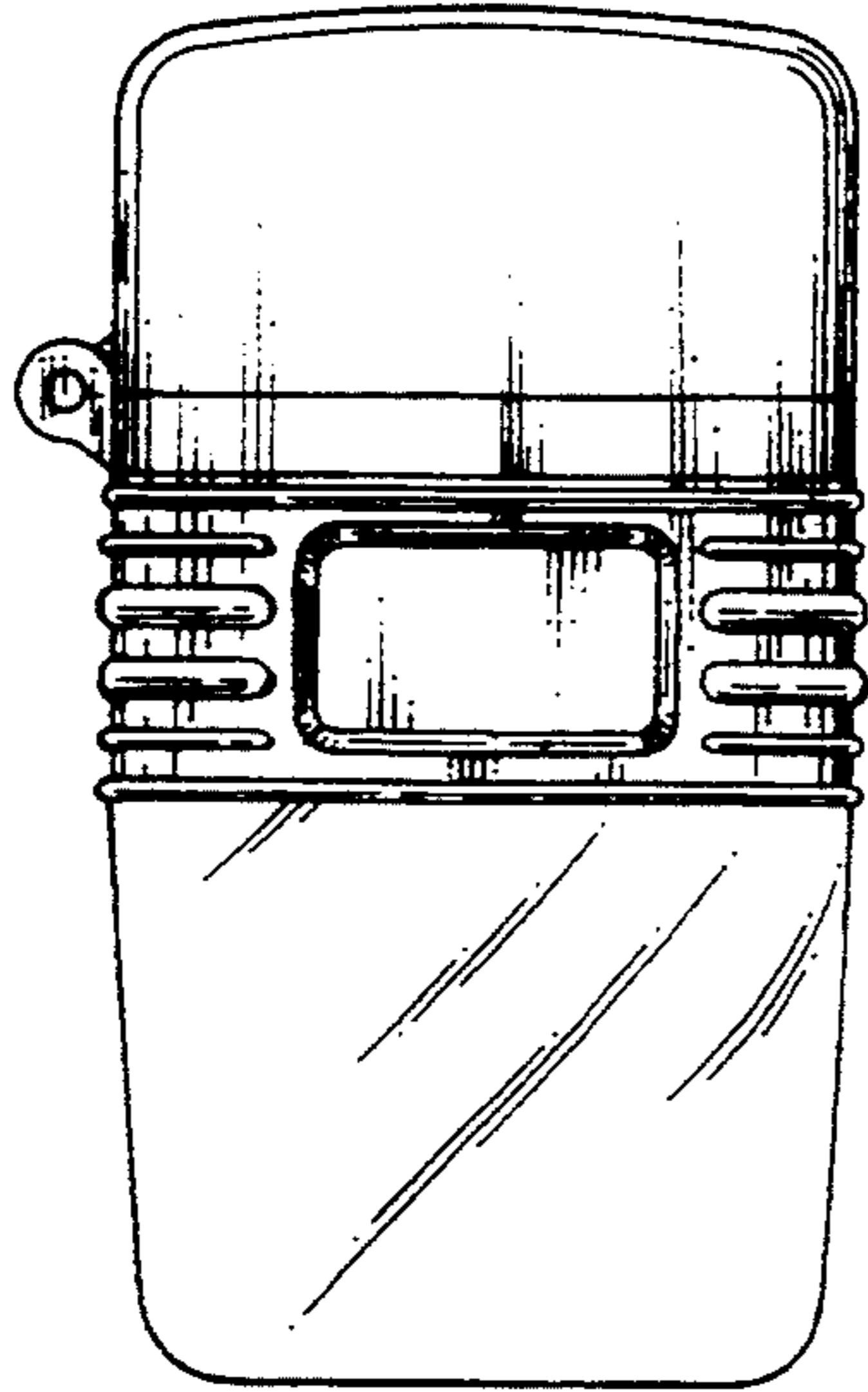

FIG. 3

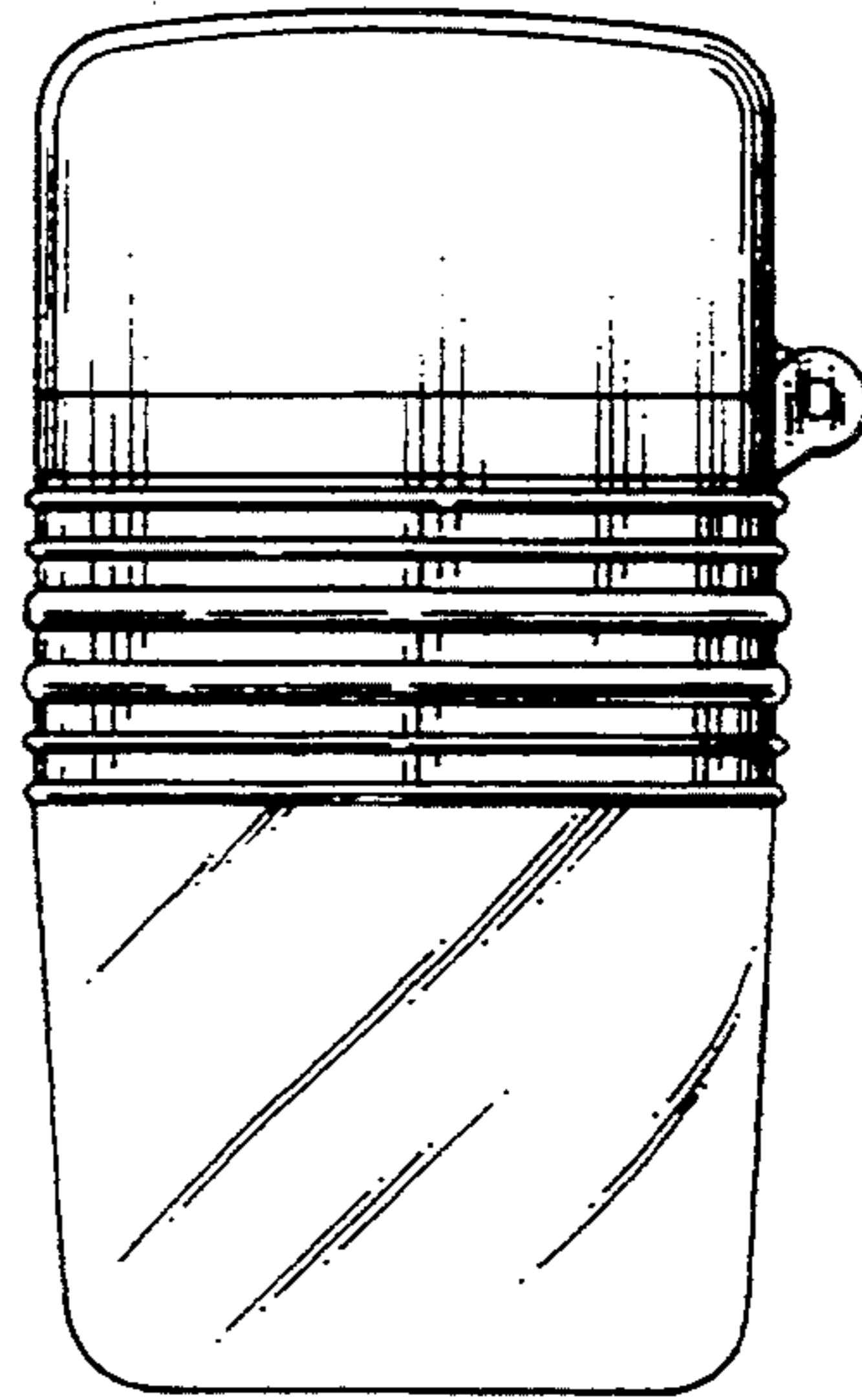

FIG. 4

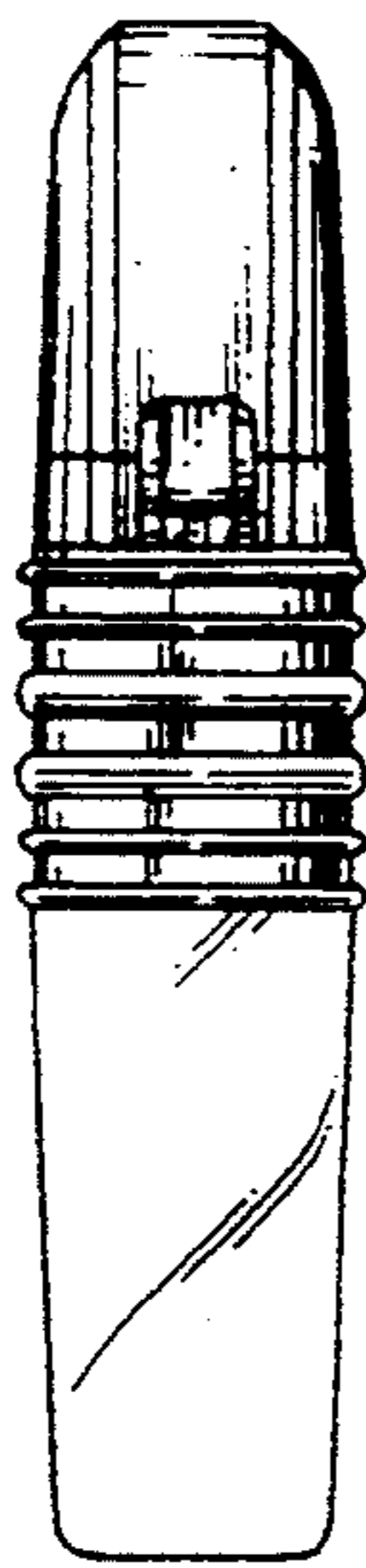

FIG. 5



FIG. 6



FIG. 7

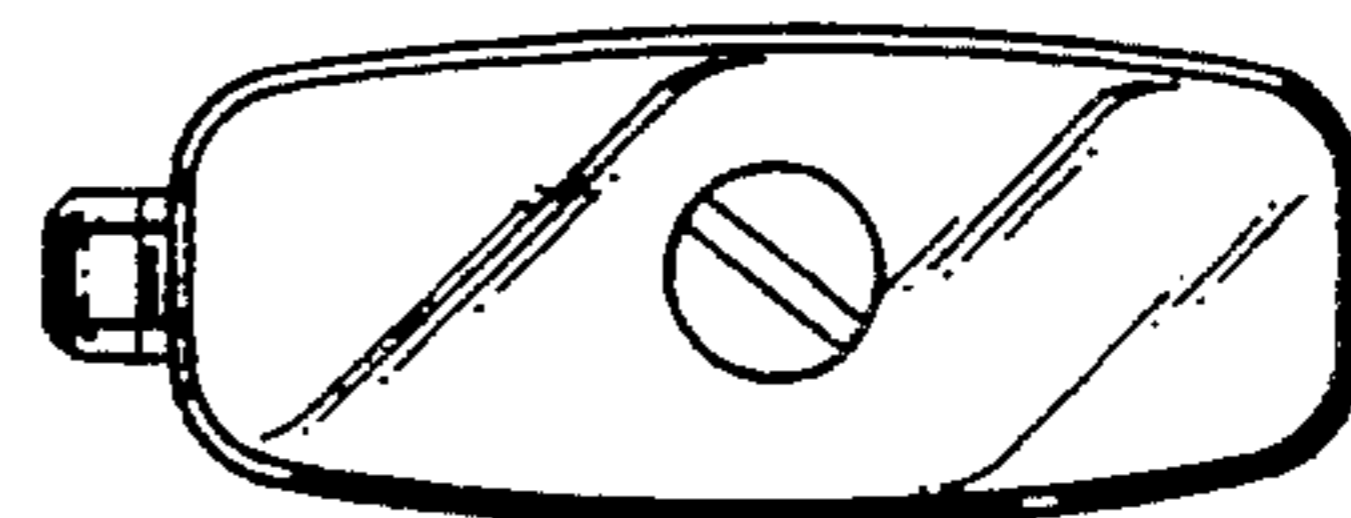

FIG. 8

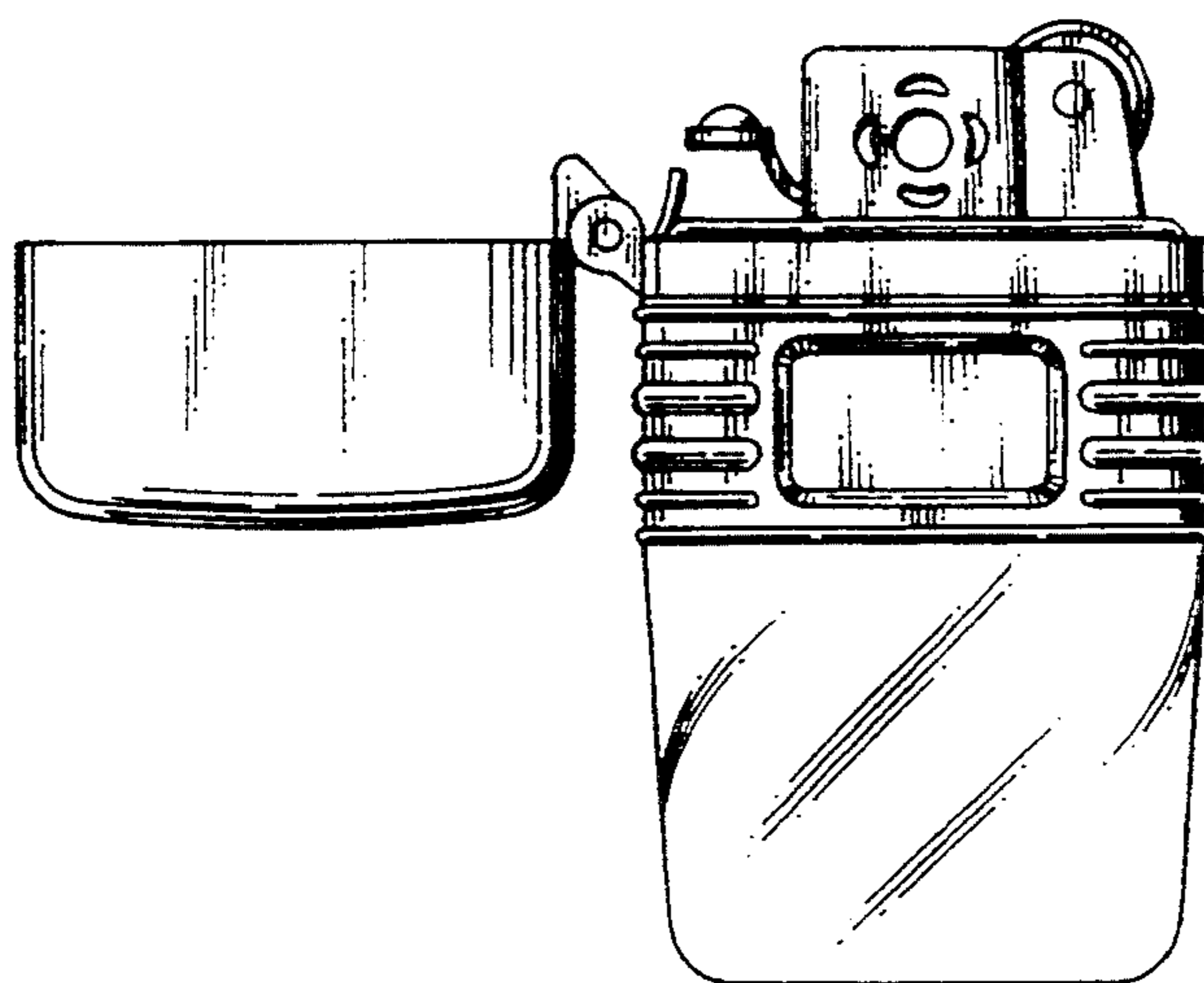

FIG. 9

