



US00D359745S

United States Patent [19]

[11] Patent Number: **Des. 359,745**

Arai

[45] Date of Patent: **** Jun. 27, 1995**

[54] **SINGLE-USE CAMERA**

[75] Inventor: **Takuya Arai, Kanagawa, Japan**

[73] Assignee: **Fuji Photo Film Co., Ltd., Kanagawa, Japan**

[*] Notice: The portion of the term of this patent subsequent to Mar. 29, 2008 has been disclaimed.

[**] Term: **14 Years**

[21] Appl. No.: **21,032**

[22] Filed: **Apr. 6, 1994**

[52] U.S. Cl. **D16/208; D16/209**

[58] Field of Search **D9/307, 418, 432; D16/200-205, 208, 209, 212, 217, 218; 354/75, 126, 149.11, 152, 202, 288, 64, 65**

[56] **References Cited**

U.S. PATENT DOCUMENTS

D. 228,681	10/1973	Swayze	D16/213
D. 306,691	3/1990	Arai	D9/305
D. 311,335	10/1990	Arai	D9/432
D. 313,183	12/1990	Arai	D9/432
D. 313,937	1/1991	Arai	D9/432
D. 313,938	1/1991	Arai	D9/432
D. 315,727	3/1991	Arai et al.	D14/121
D. 315,916	4/1991	Leonard et al.	D16/218
D. 320,937	10/1991	Arai	D9/432
D. 321,705	11/1991	Ohmura et al.	D16/208
D. 323,842	2/1992	Arai	D16/208
D. 323,843	2/1992	Arai	D16/208
D. 325,741	4/1992	Arai	D16/208
D. 325,922	5/1992	Arai	D16/208
D. 326,814	6/1992	Arai	D9/415
D. 328,911	8/1992	Arai et al.	D16/208
D. 328,912	8/1992	Arai et al.	D16/208
D. 330,563	10/1992	Kohno et al.	D16/208
D. 330,564	10/1992	Kohno et al.	D16/208
D. 332,109	12/1992	Kohno et al.	D16/208
D. 335,297	5/1993	Kawagoe	D16/208
D. 344,532	2/1994	Takiguchi et al.	D16/208
D. 345,569	3/1994	Yasunaga	D16/208
D. 345,570	3/1994	Yasunaga	D16/208
4,801,957	1/1989	Vandemoere	354/147
4,882,600	11/1989	Vandemoere	354/64

5,003,330	3/1991	Kotani et al.	354/145
5,047,792	9/1991	Asano et al.	354/149.11

FOREIGN PATENT DOCUMENTS

0527430	2/1993	European Pat. Off.	354/288
62-41507	4/1989	Japan	.	
62-41506	5/1989	Japan	.	
62-41508	5/1989	Japan	.	
62-41509	5/1989	Japan	.	
63-954	8/1991	Japan	.	
63-7916	8/1991	Japan	.	
1-11317	8/1991	Japan	.	
759660-D11	8/1991	Japan	.	
759660-D14	8/1991	Japan	.	
759660-D18	8/1991	Japan	.	
759660-D25	12/1991	Japan	.	
825109	12/1991	Japan	.	
2257801	1/1993	United Kingdom	354/288

Primary Examiner—Terry A. Wallace
Assistant Examiner—Adir Aronovich
Attorney, Agent, or Firm—Young & Thompson

[57] **CLAIM**

The ornamental design for a single use camera, as shown and described.

DESCRIPTION

FIG. 1 is a top, front and side perspective view of a first embodiment of a single-use camera showing my new design;

FIG. 2 is a front elevational view thereof;

FIG. 3 is a rear elevational view thereof;

FIG. 4 is a top plan view thereof;

FIG. 5 is a bottom plan view thereof;

FIG. 6 is a side elevational view thereof taken from the left of FIG. 2;

FIG. 7 is a side elevational view thereof taken from the right of FIG. 2;

FIG. 8 is a top, front and left side perspective view of a second embodiment of the camera shown in FIG. 1;

FIG. 9 is a front elevational view thereof;

FIG. 10 is a rear elevational view thereof;

FIG. 11 is a top plan view thereof;

FIG. 12 is a bottom plan view thereof;

FIG. 13 is a left side elevational view thereof; and,

FIG. 14 is a right side elevational view thereof.

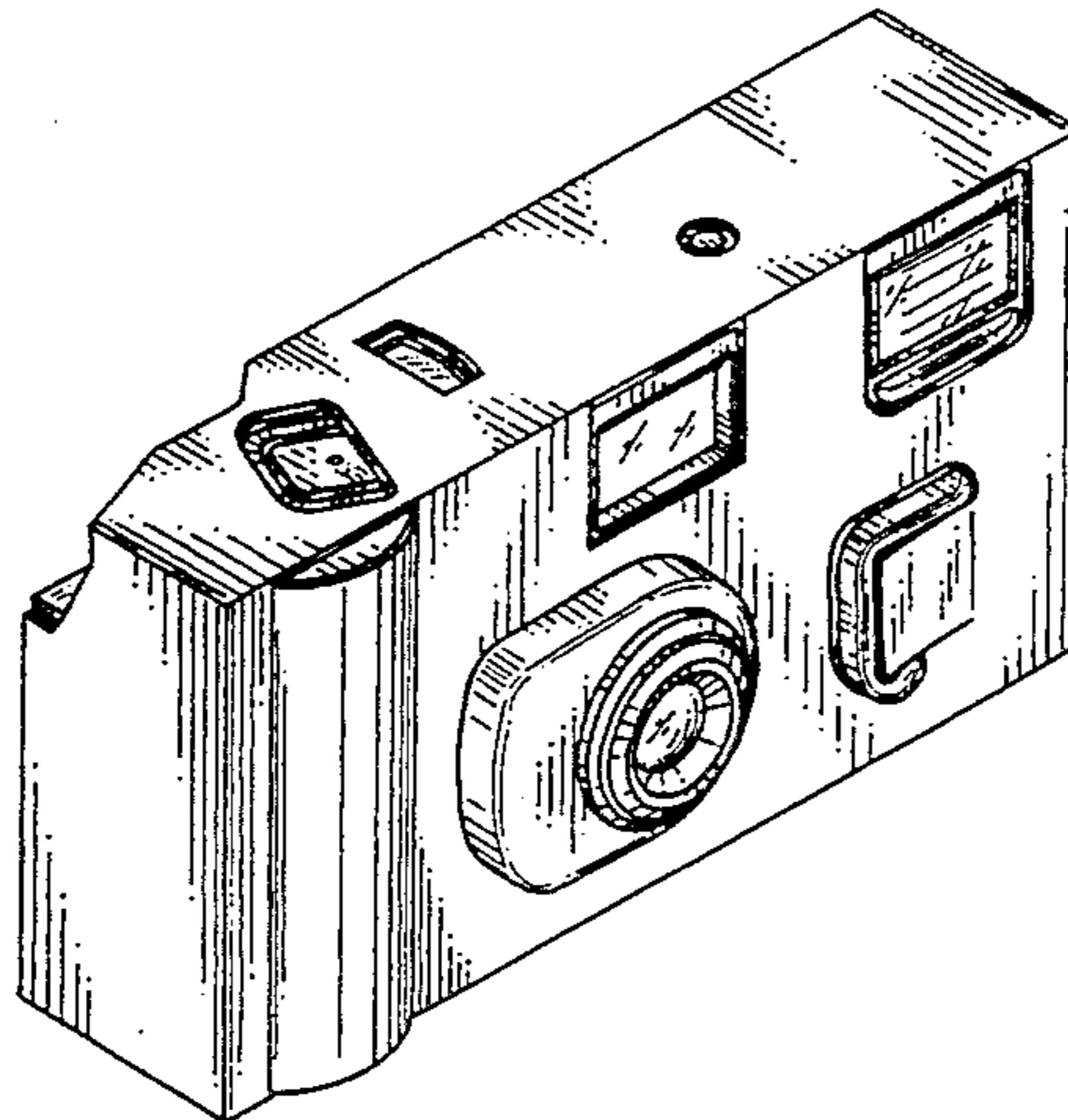

FIG. 1

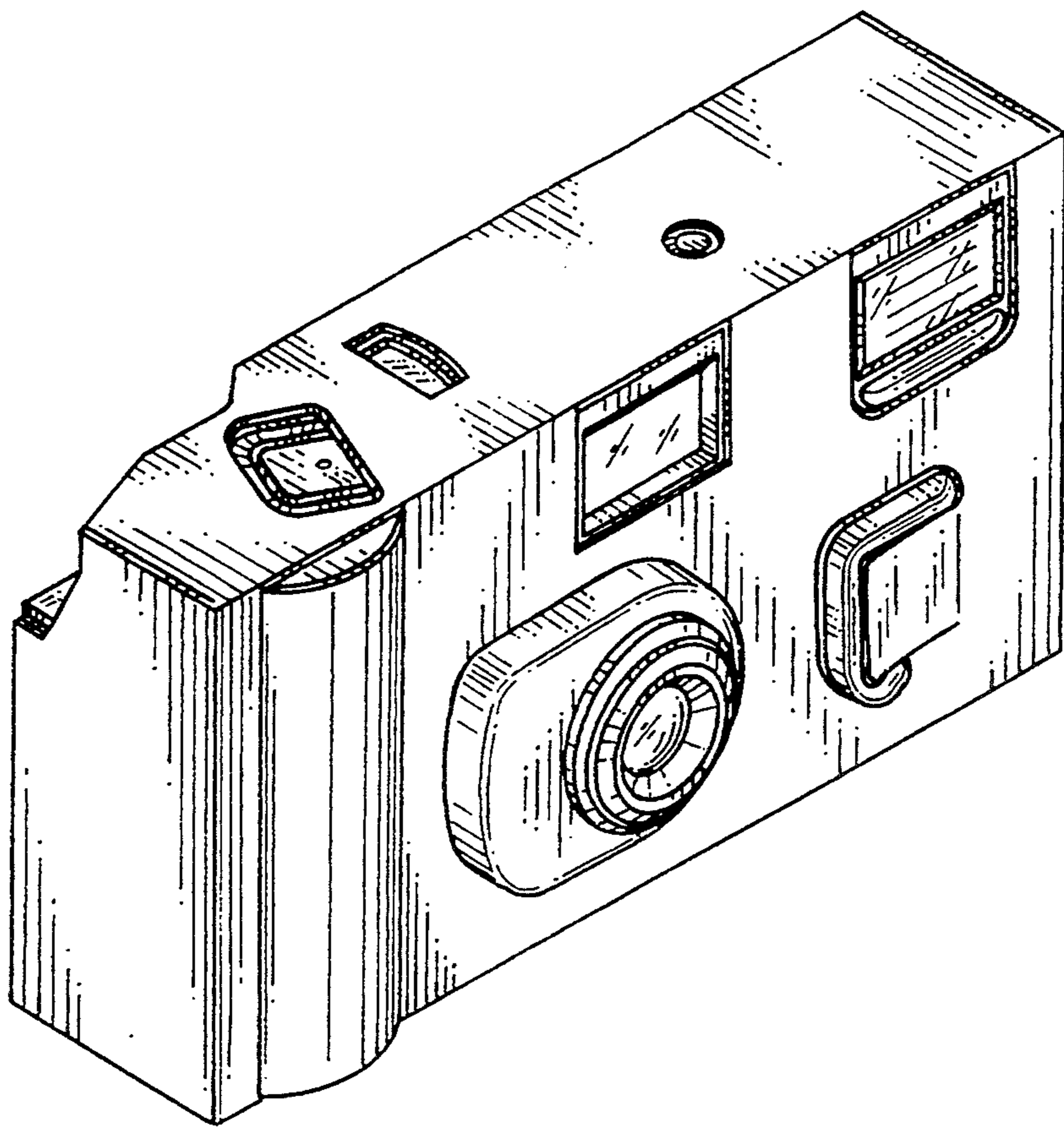

FIG. 2

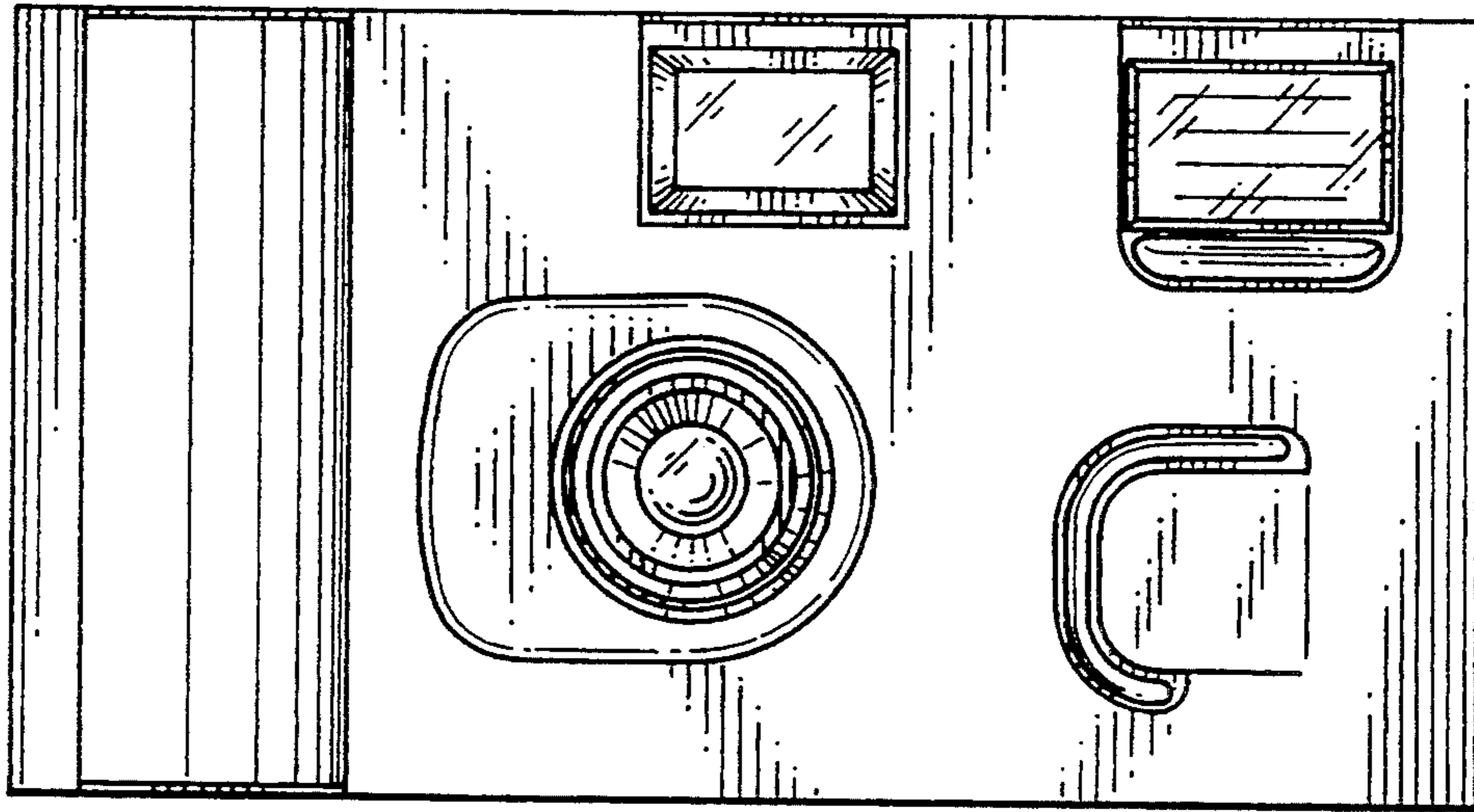

FIG. 3

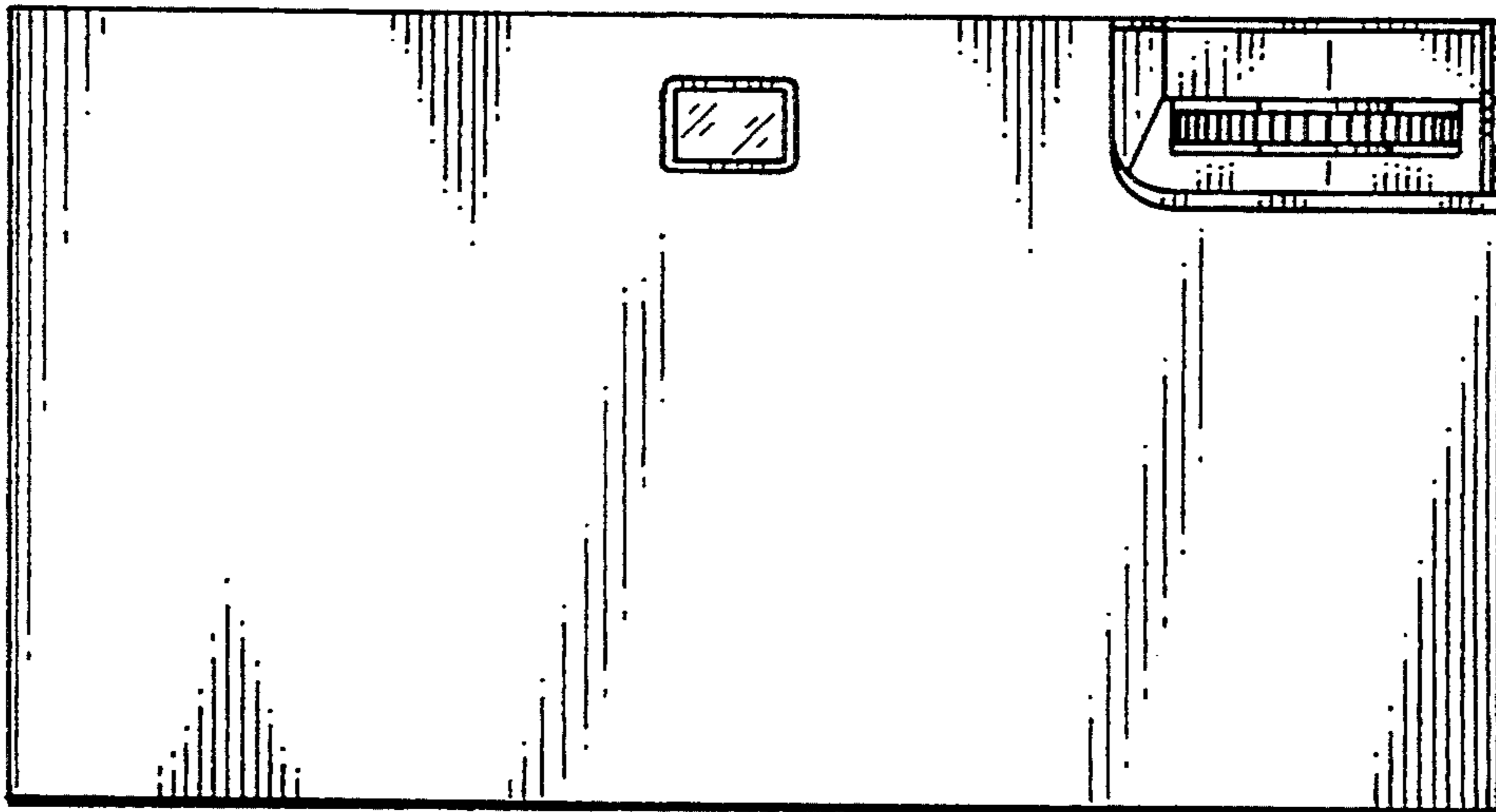

FIG. 4

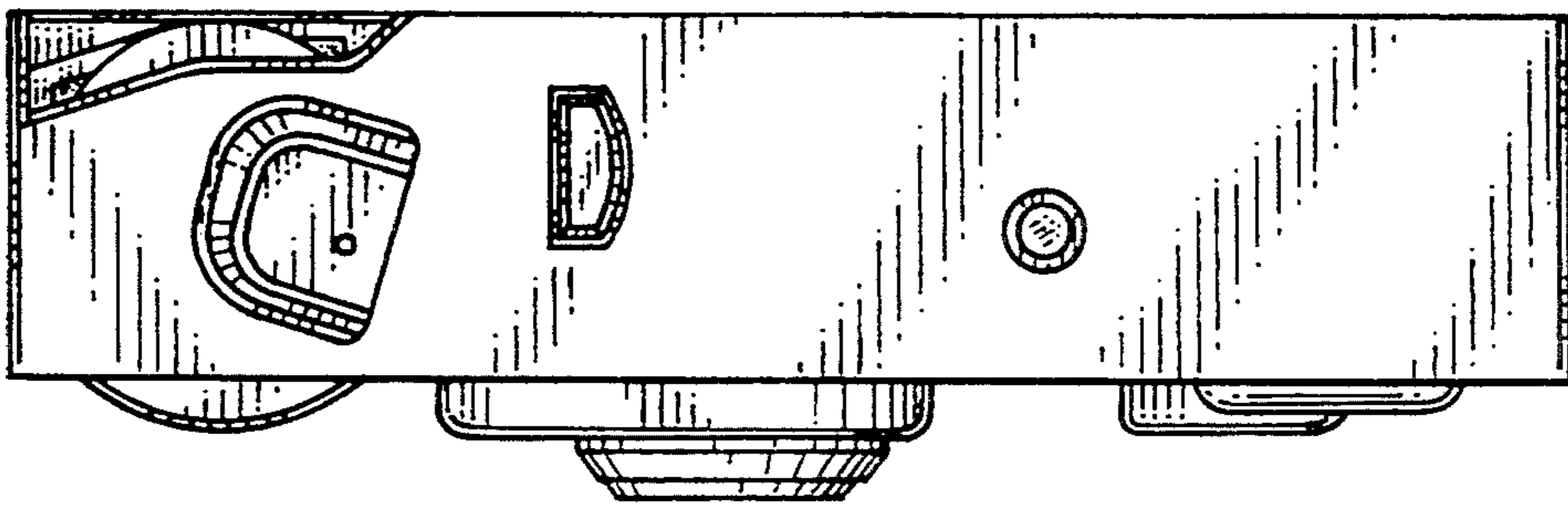

FIG. 5

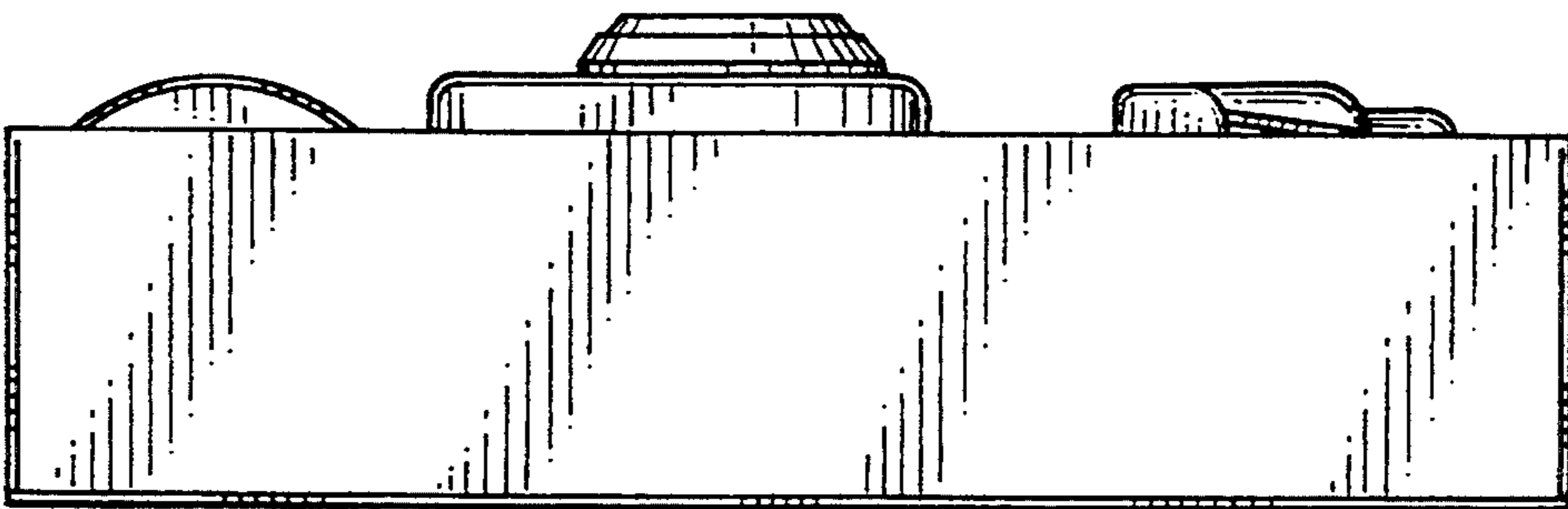

FIG. 6

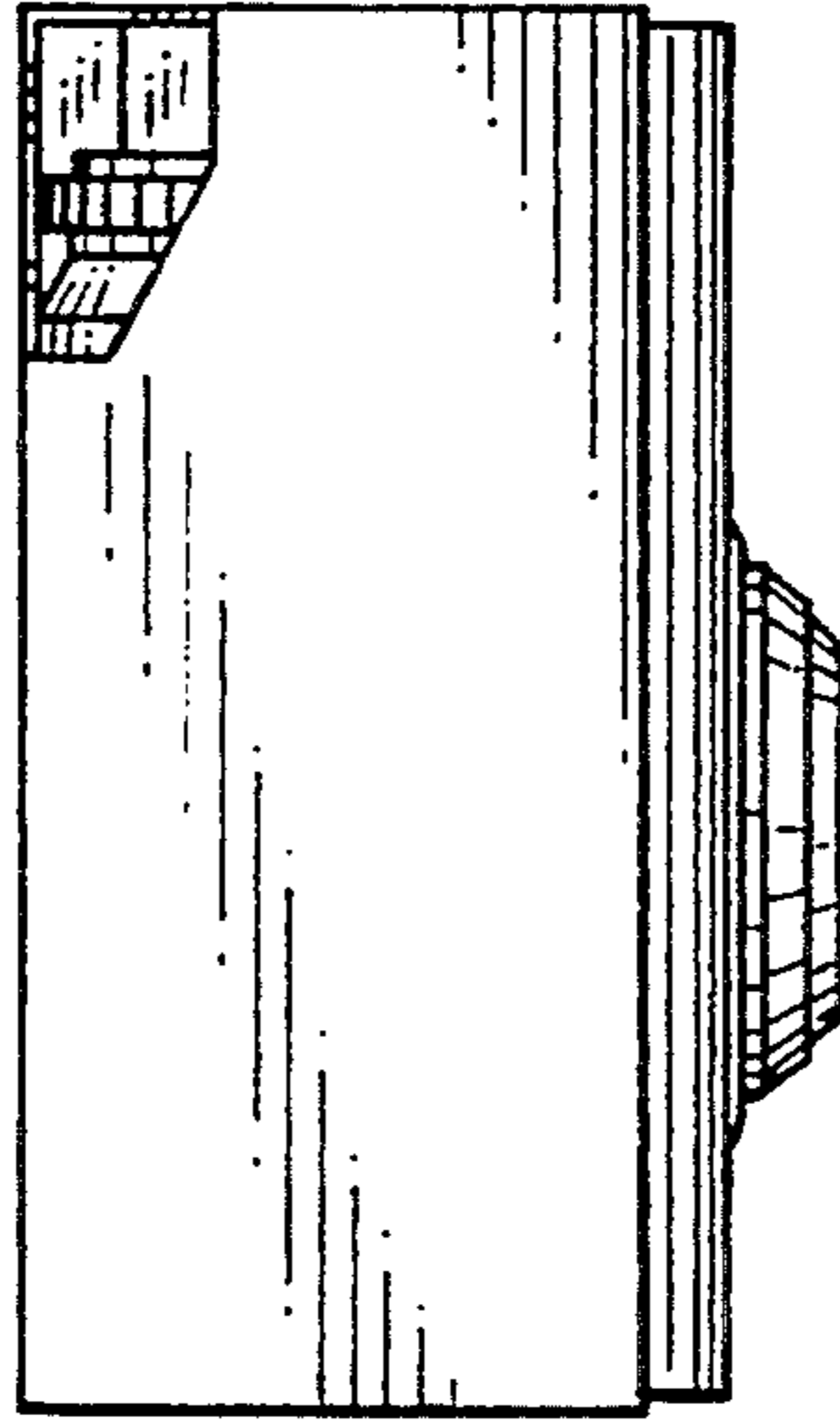

FIG. 7

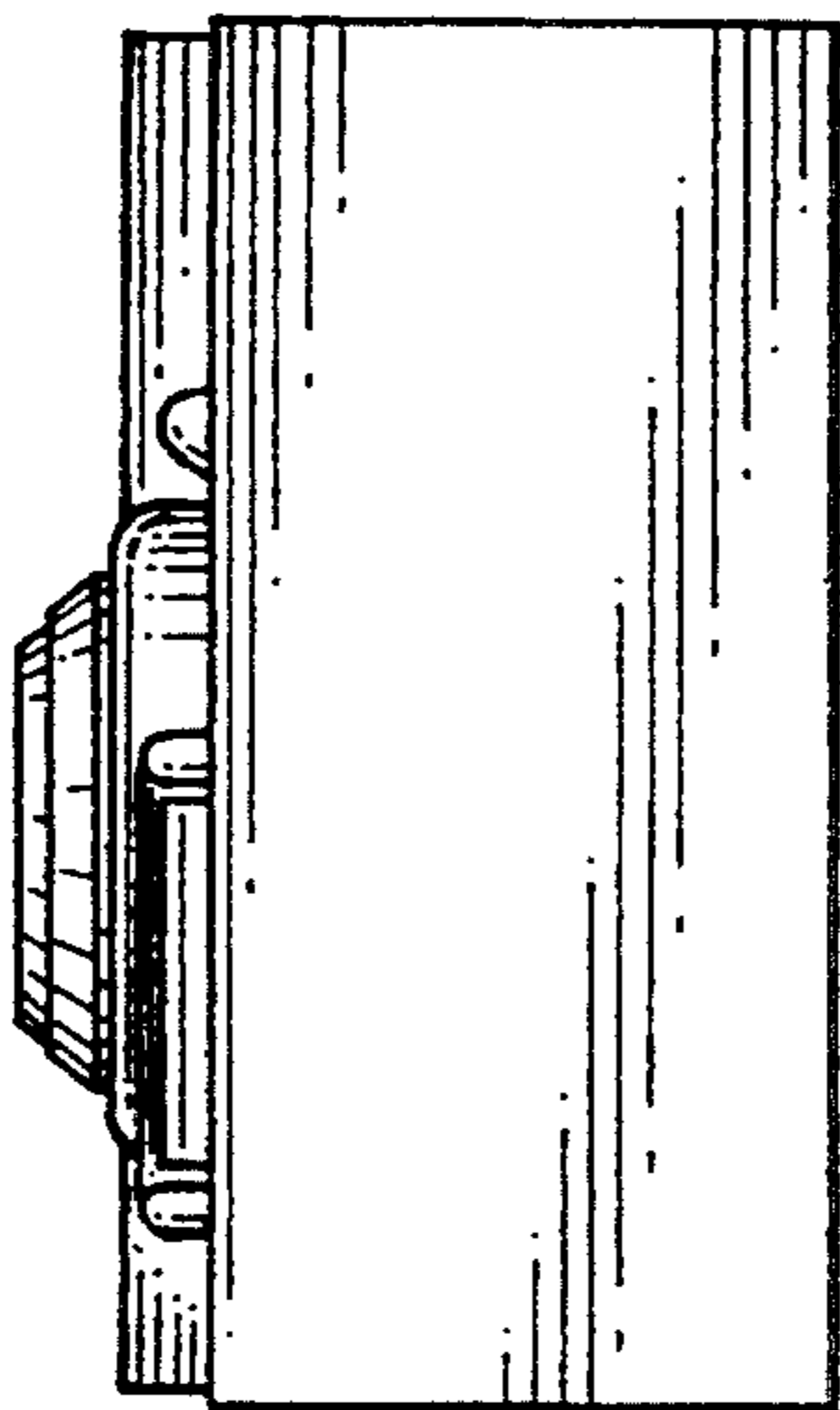

FIG. 8

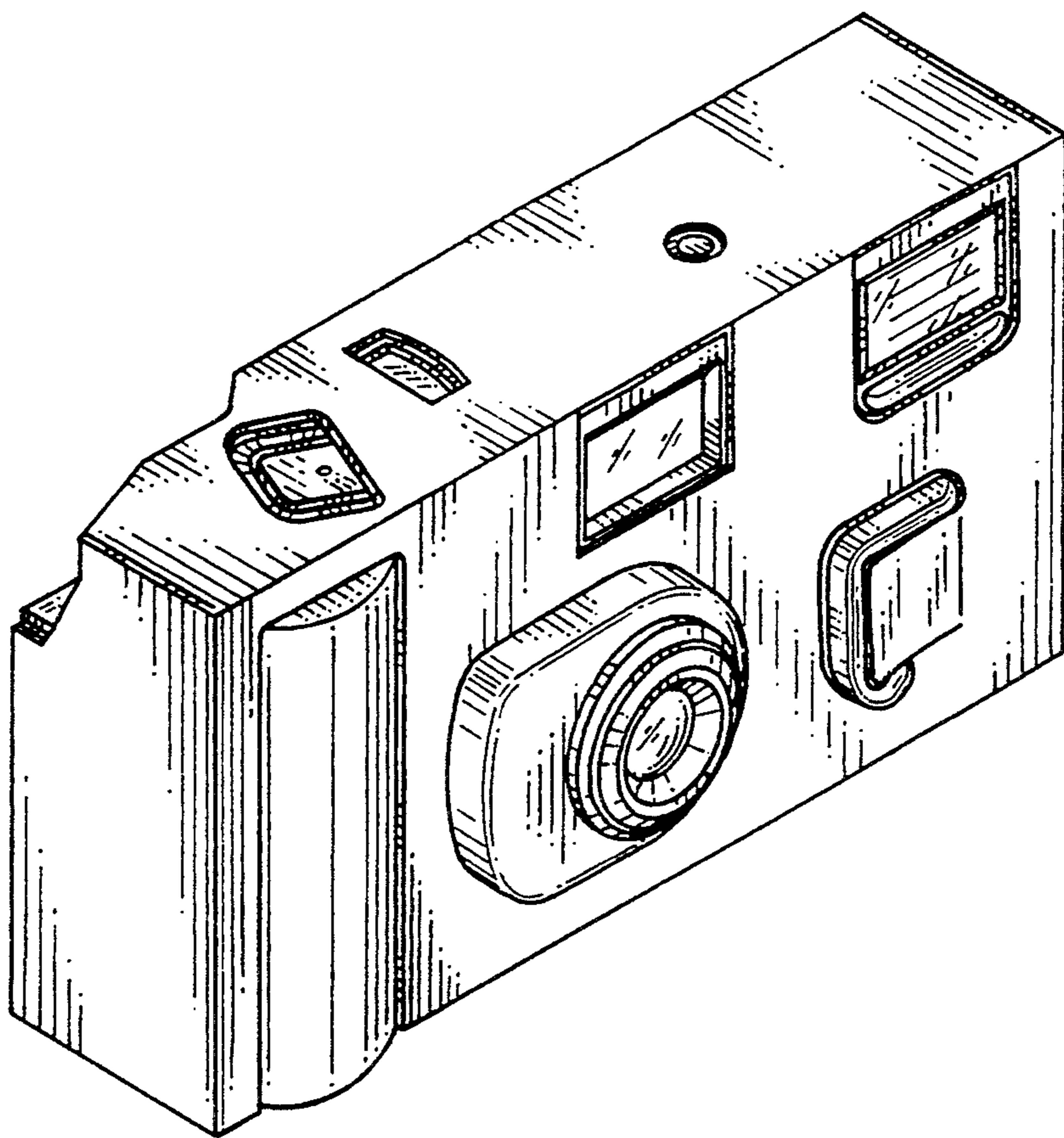

FIG. 9

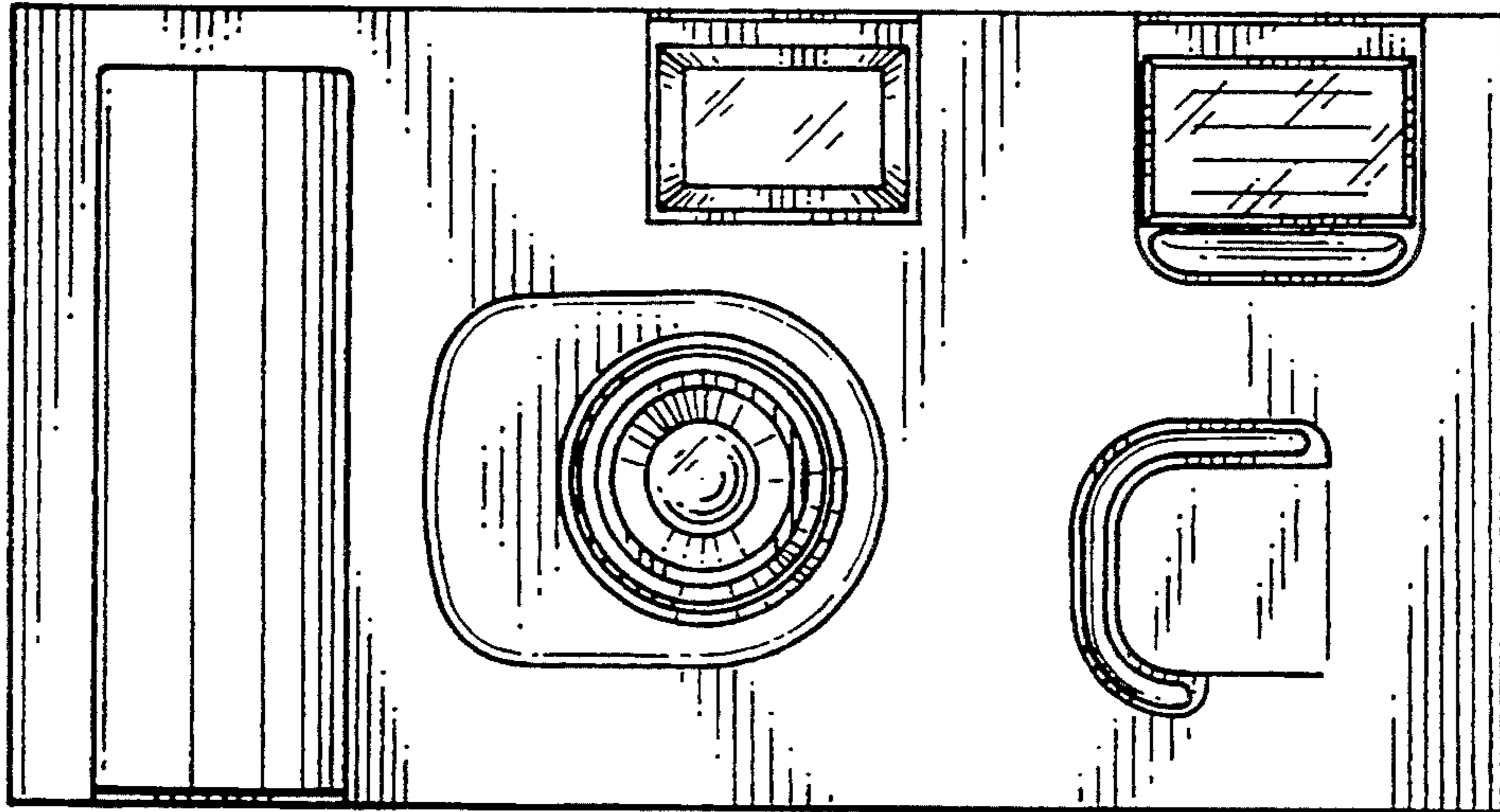

FIG. 10

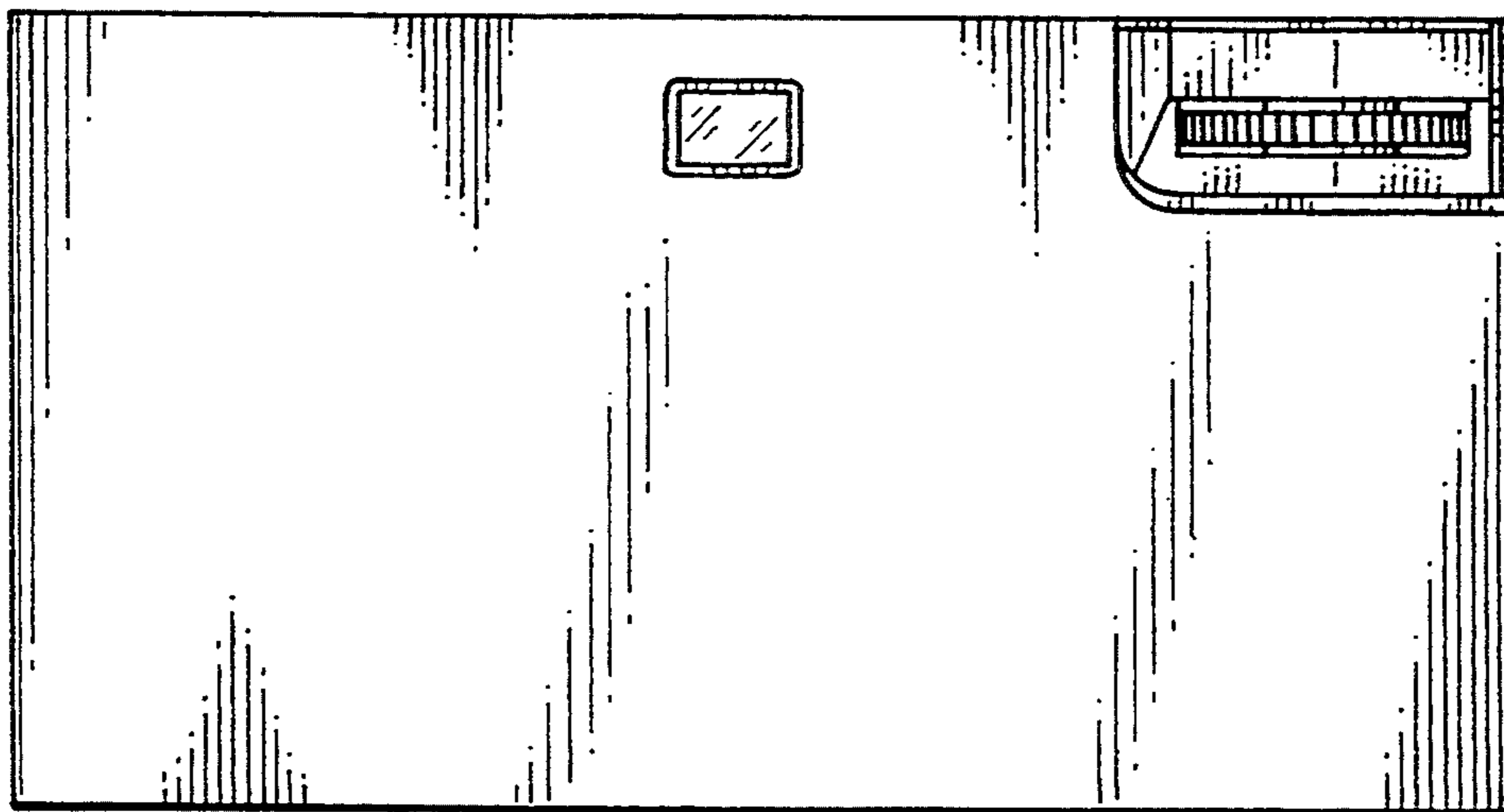

FIG. 11

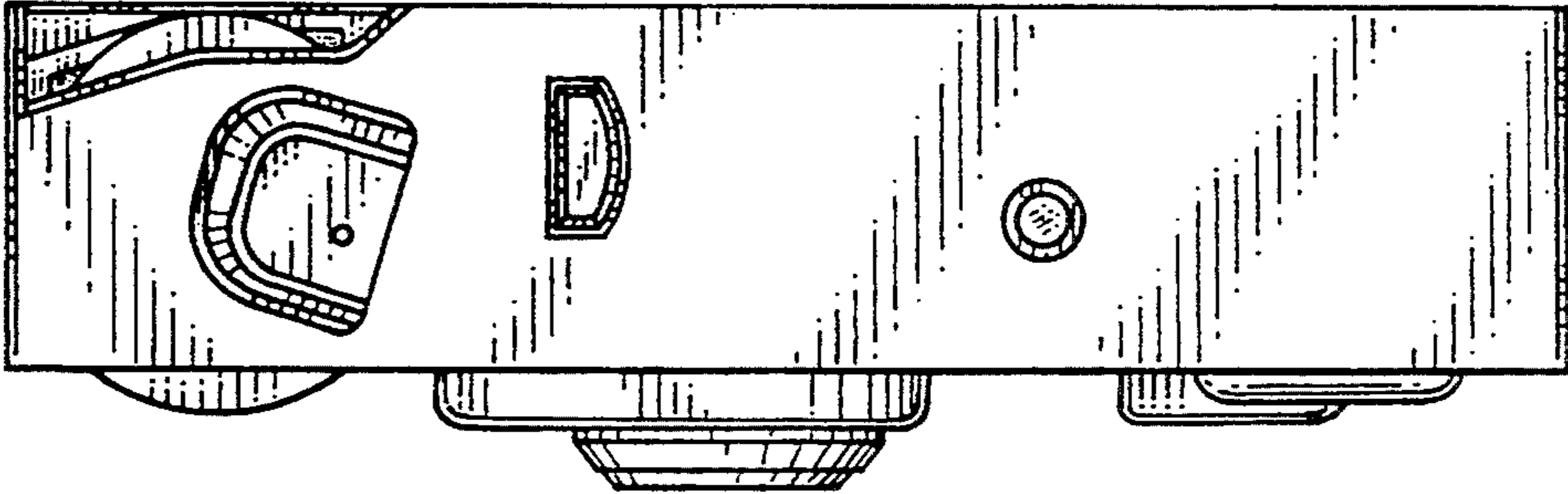

FIG. 12

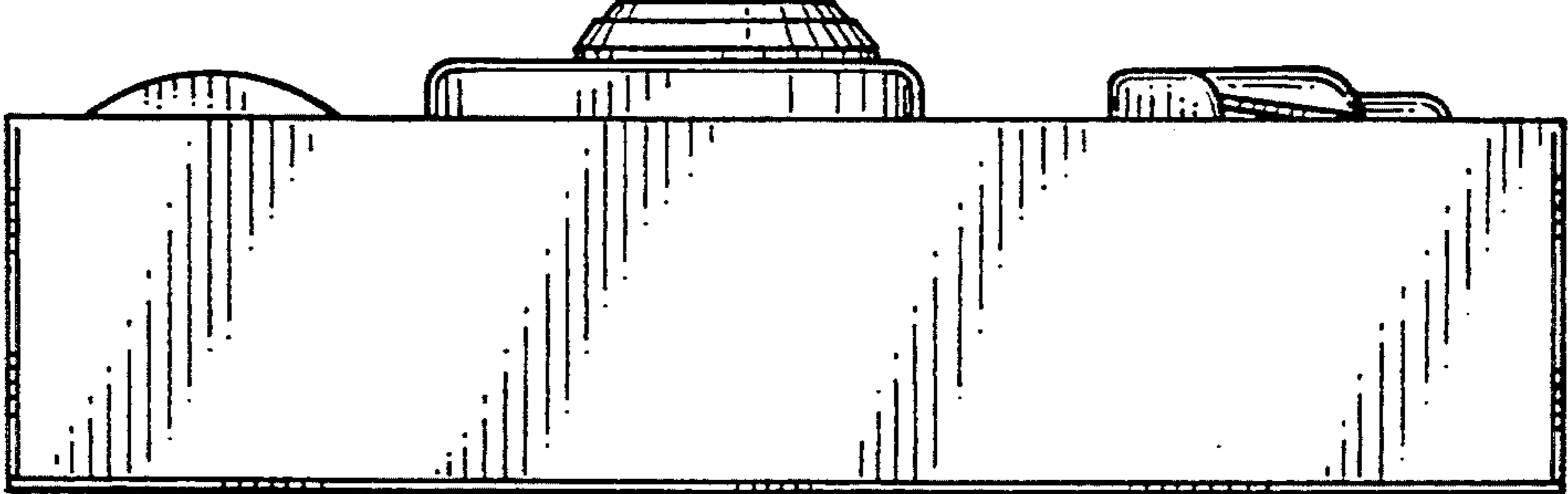

FIG. 13

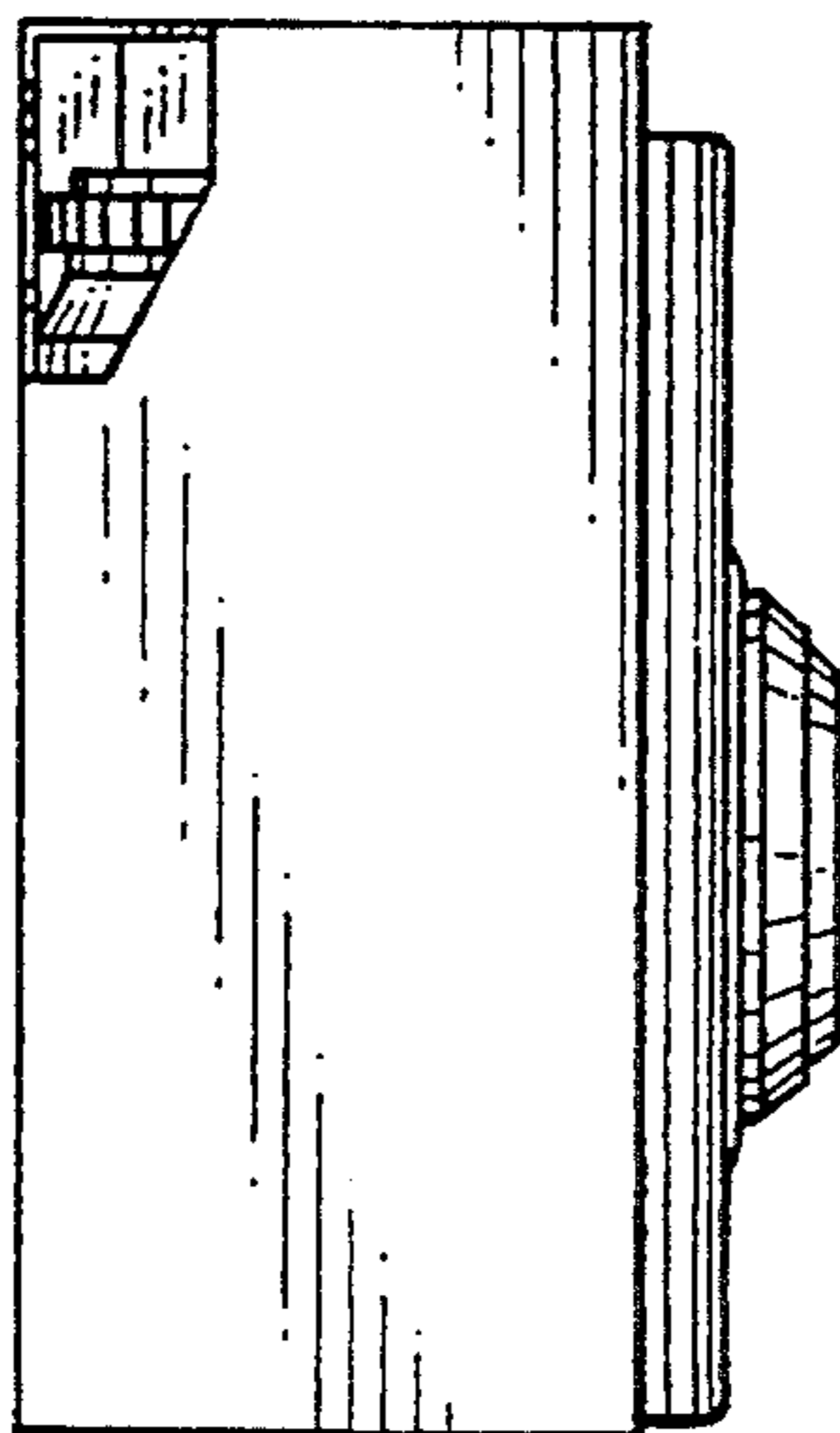

FIG. 14

