



US00D359726S

United States Patent [19]

[11] Patent Number: **Des. 359,726**

Umeya et al.

[45] Date of Patent: **** Jun. 27, 1995**

[54] **FASTENER FOR AN ELECTRONIC COMPONENT**

[75] Inventors: **Tatuo Umeya; Toru Mizuno; Hidetoshi Suzuki; Tokio Tadano; Takashi Shioura**, all of Tokyo, Japan

[73] Assignee: **TDK Corporation**, Tokyo, Japan

[**] Term: **14 Years**

[21] Appl. No.: **440,564**

[22] Filed: **Nov. 22, 1989**

[30] **Foreign Application Priority Data**

May 23, 1989 [JP] Japan 1-18681

[52] U.S. Cl. **D13/199; D8/395**

[58] Field of Search **D13/199, 154, 173; D8/366, 382, 394, 395; 439/279, 350, 353, 357, 573, 680, 686; 174/50; 361/386; 248/231.8, 309.1, 316.7; 24/530, 351, 363; 403/387**

[56] **References Cited**

U.S. PATENT DOCUMENTS

D. 186,435	10/1959	Wilson	D8/395
D. 299,392	11/1973	Faust	D8/394
2,230,923	2/1941	Barry	248/309.1
2,467,604	4/1949	Tinnerman et al.	24/563 X
2,869,098	1/1959	Sauer	439/353
2,932,000	4/1960	Buchanan	439/686 X
4,186,987	2/1980	Pearce, Jr. et al.	439/279
4,940,423	7/1990	Aihara et al.	439/369

FOREIGN PATENT DOCUMENTS

2915247	10/1980	Germany	439/573
0807721	1/1959	United Kingdom	24/563

OTHER PUBLICATIONS

Spring clip 19 on p. 5303 of IBM Tech. Disclosure Bulletin vol. 23 No. 12, 5-81.

Primary Examiner—Wallace R. Burke
Assistant Examiner—Joel Sincavage
Attorney, Agent, or Firm—Helfgott & Karas

[57] **CLAIM**

The ornamental design for a fastener for an electronic component, as shown and described.

DESCRIPTION

FIG. 1 is a front and upper left perspective view of a fastener for an electronic component showing our new design;
FIG. 2 is a rear and lower left perspective view thereof;
FIG. 3 is a front elevational view thereof;
FIG. 4 is a rear elevational view thereof;
FIG. 5 is a left side elevational view thereof;
FIG. 6 is a right side elevational view thereof;
FIG. 7 is a top plan view thereof;
FIG. 8 is an underneath plan view thereof; and,
FIG. 9 is a front and upper left perspective view thereof shown in use. The broken line showing of the electronic component is included for the purpose of illustrating environmental elements only and forms no part of the claimed design.

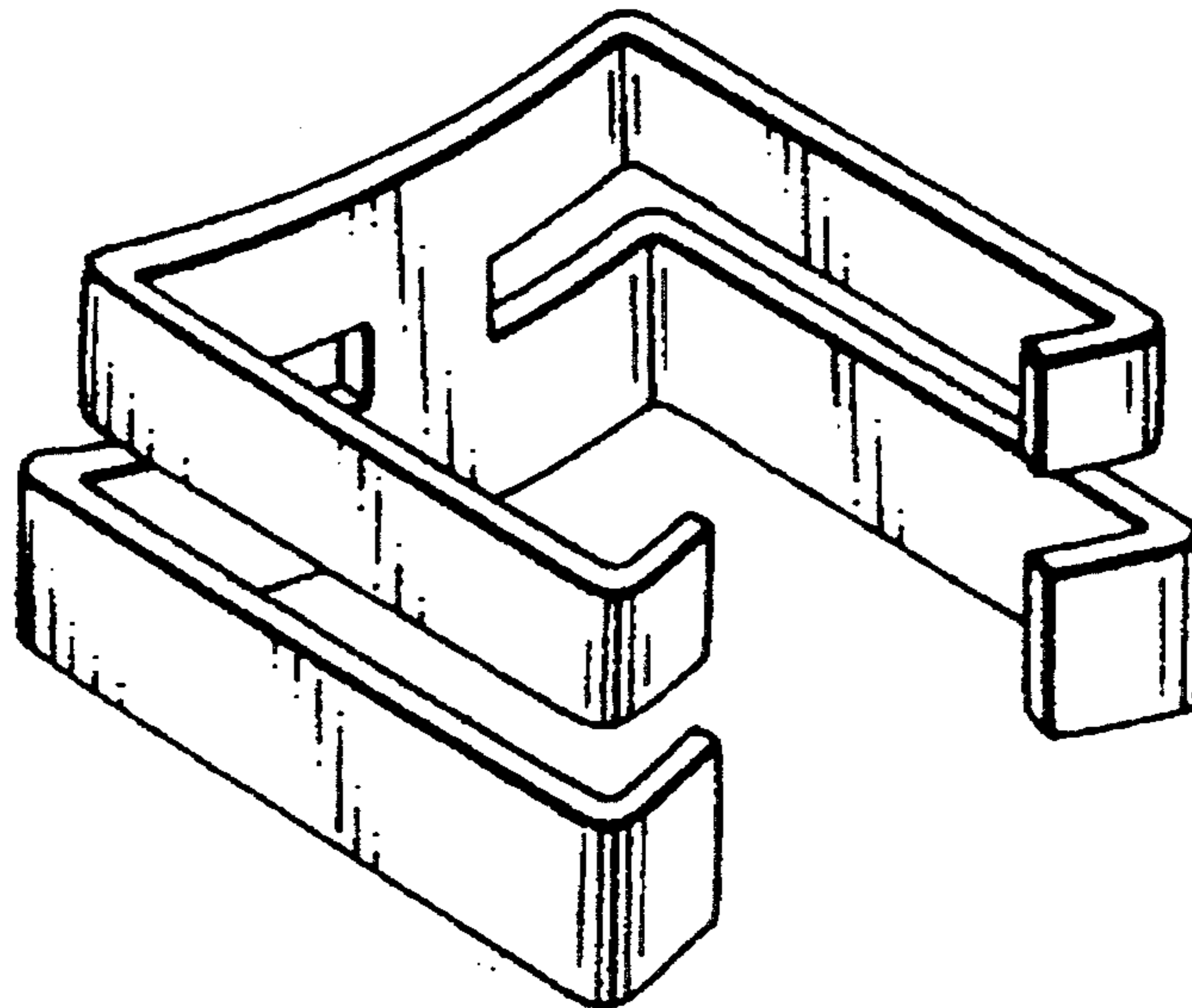

FIG. 1

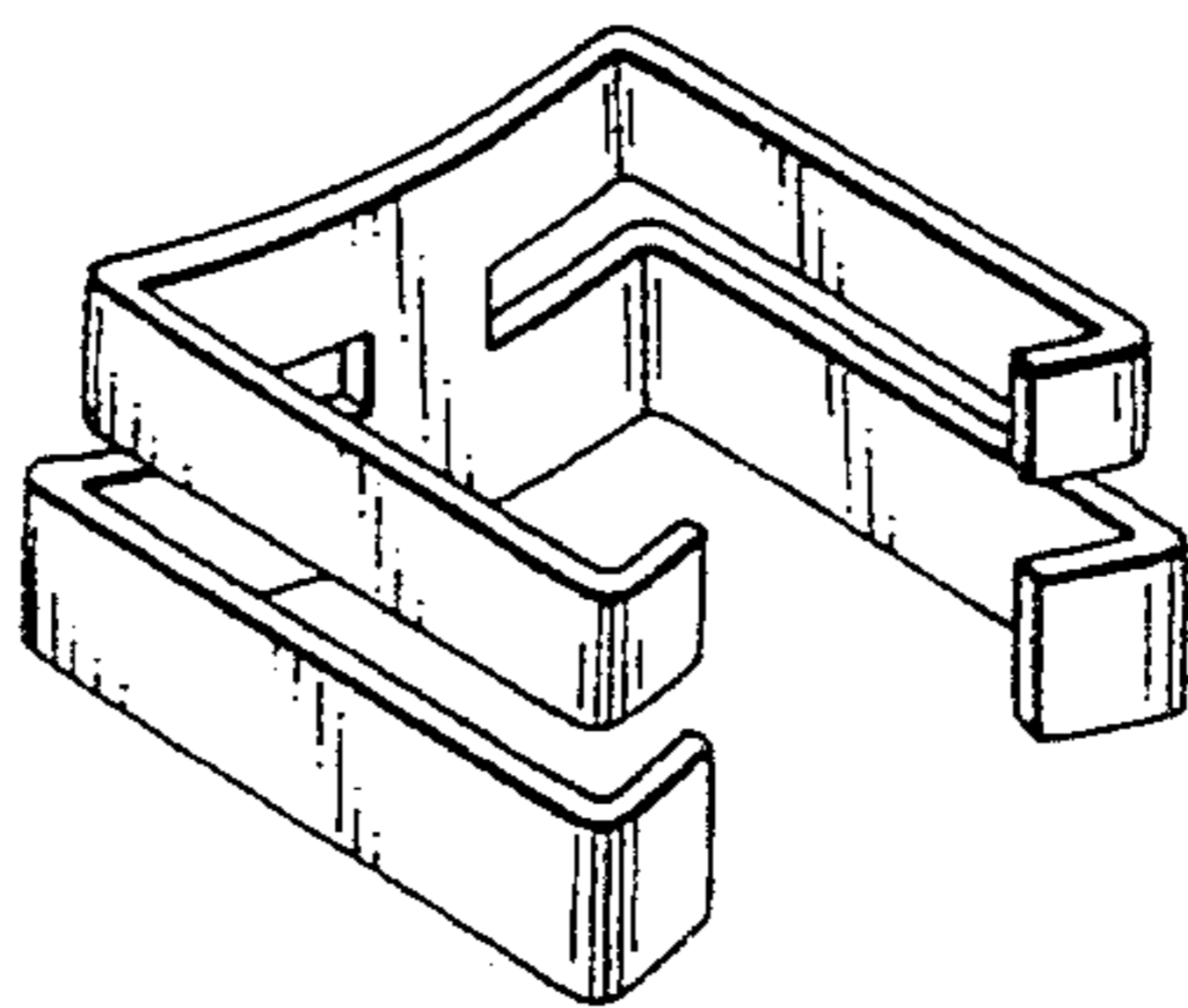

FIG. 2

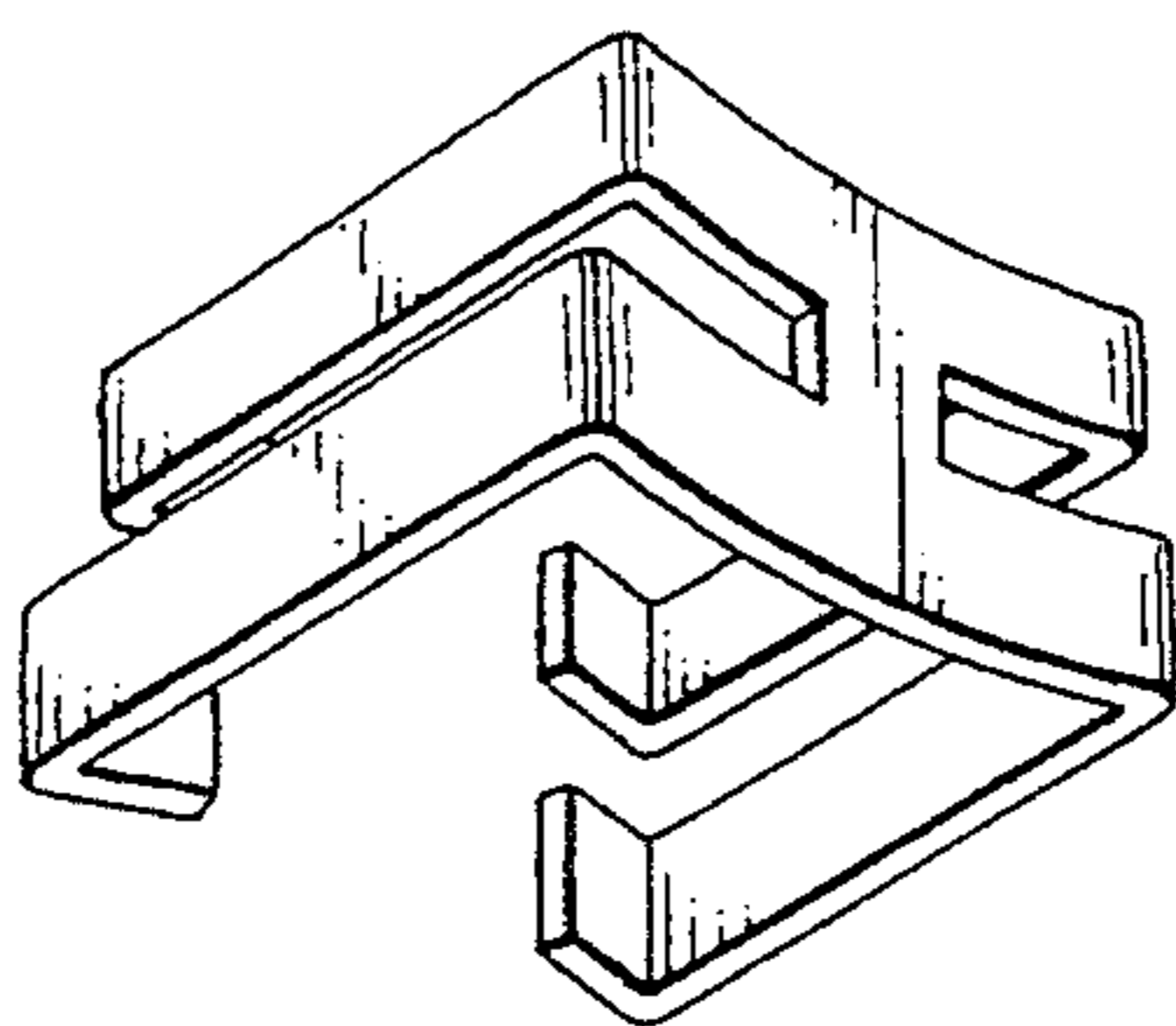

FIG. 3

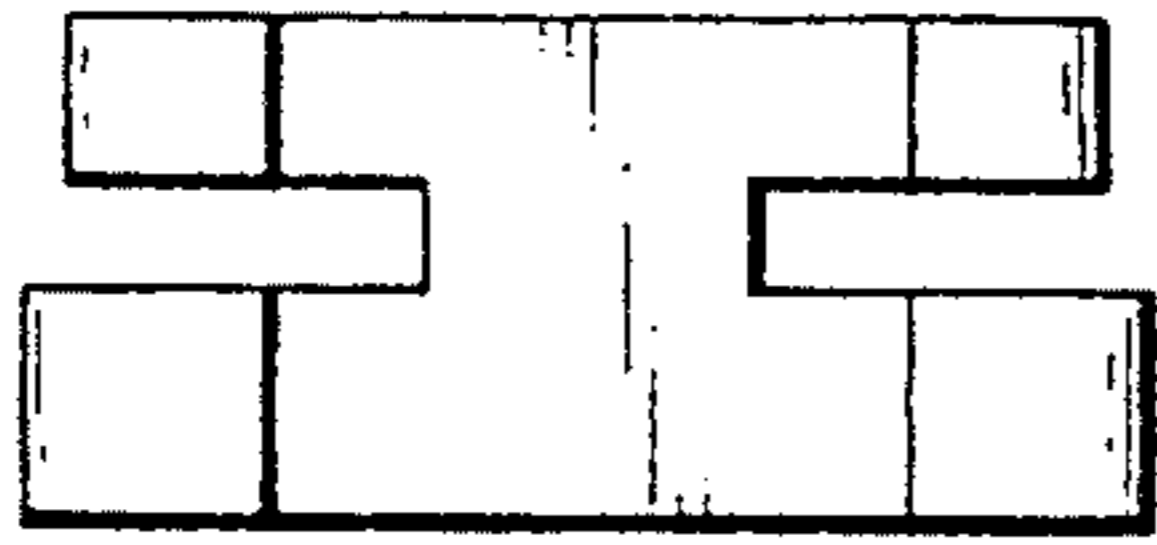

FIG. 4

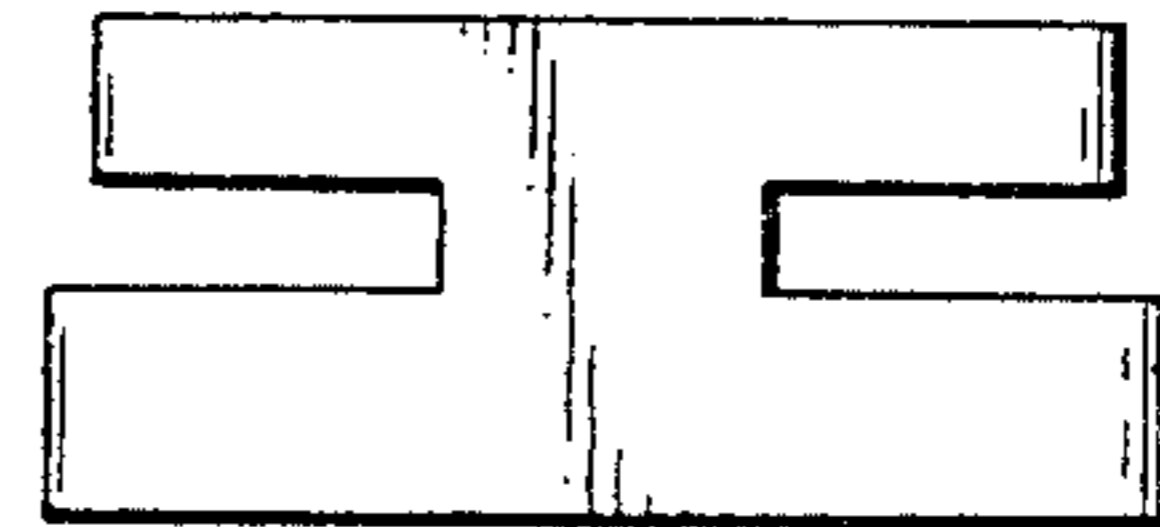

FIG. 5

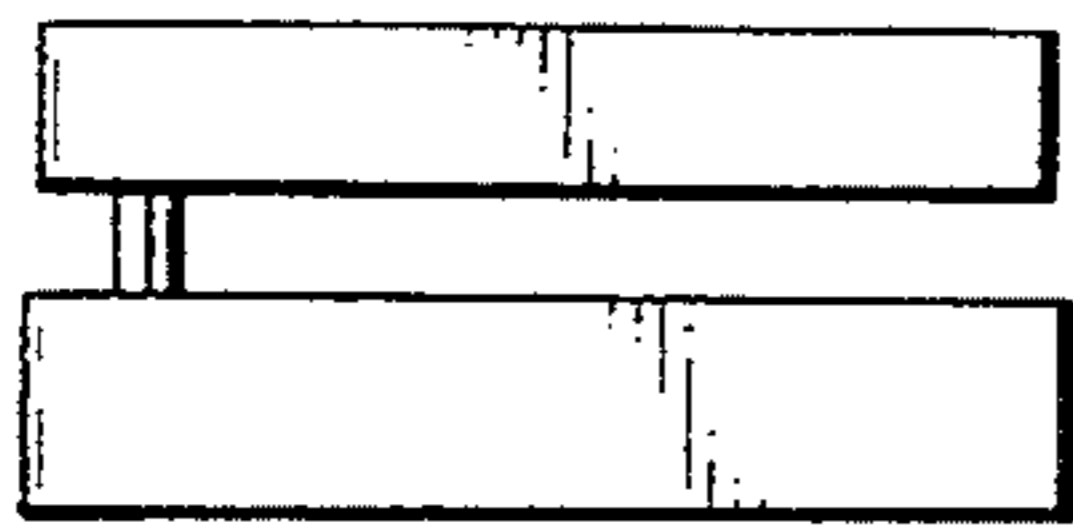

FIG. 6

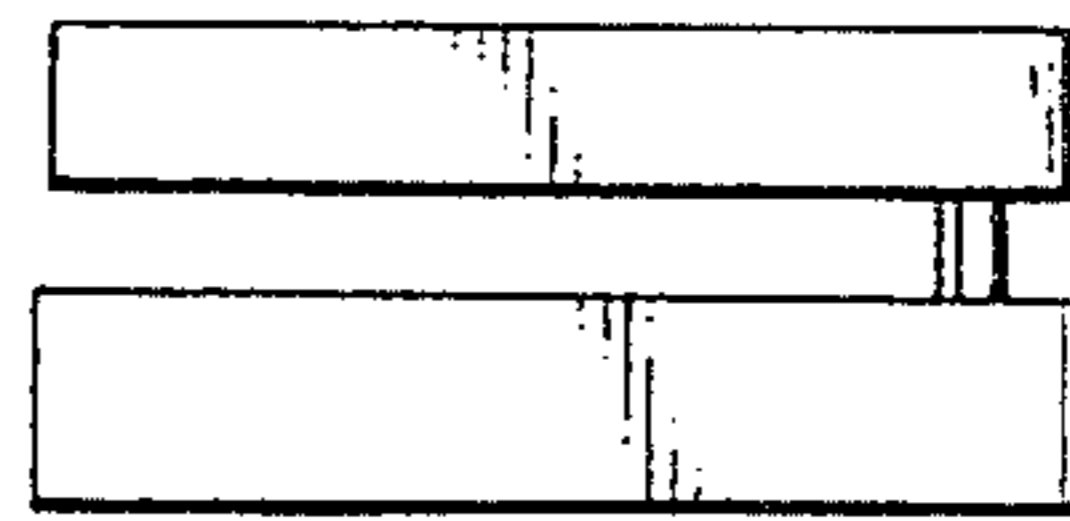

FIG. 7

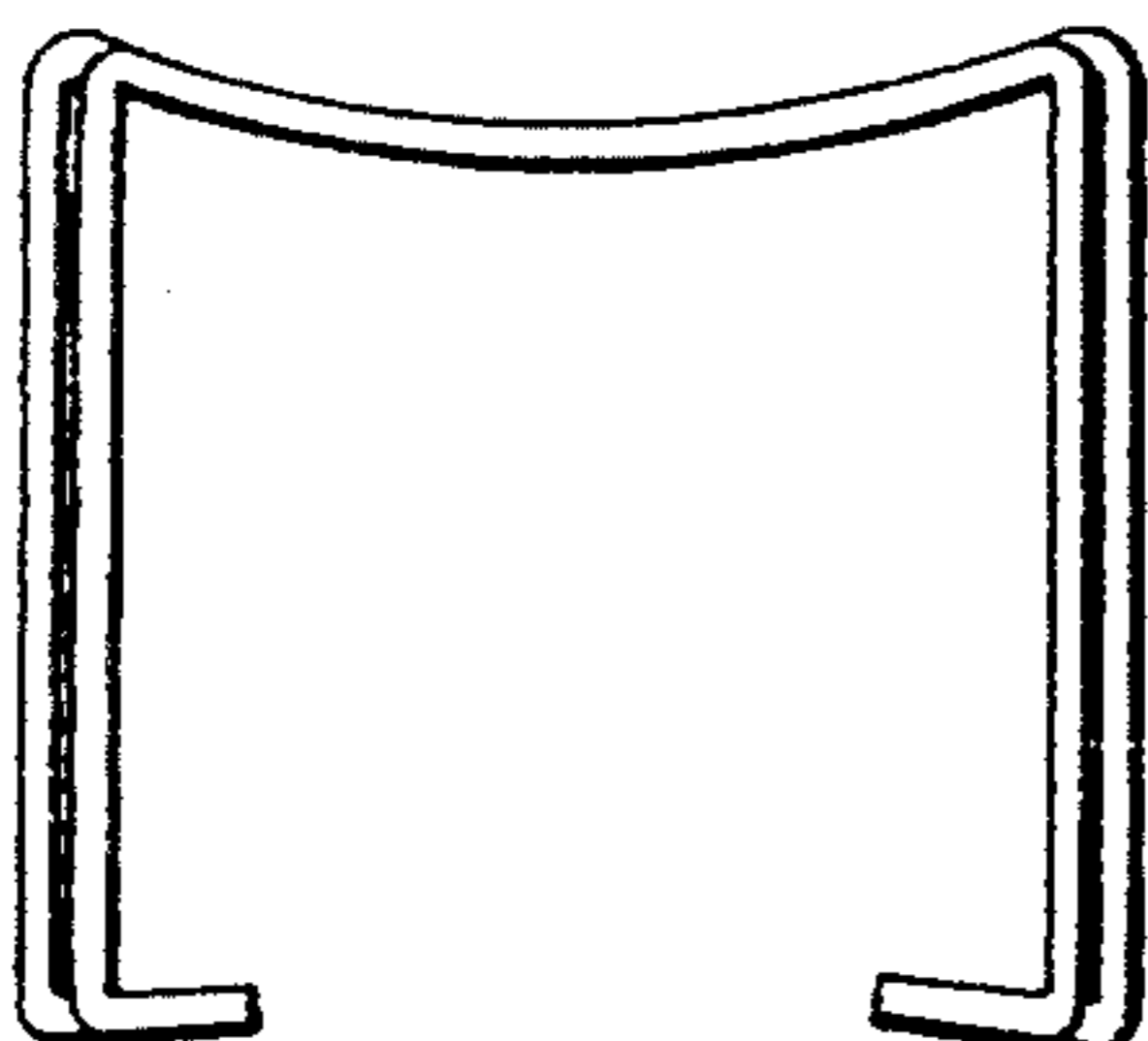

FIG. 8

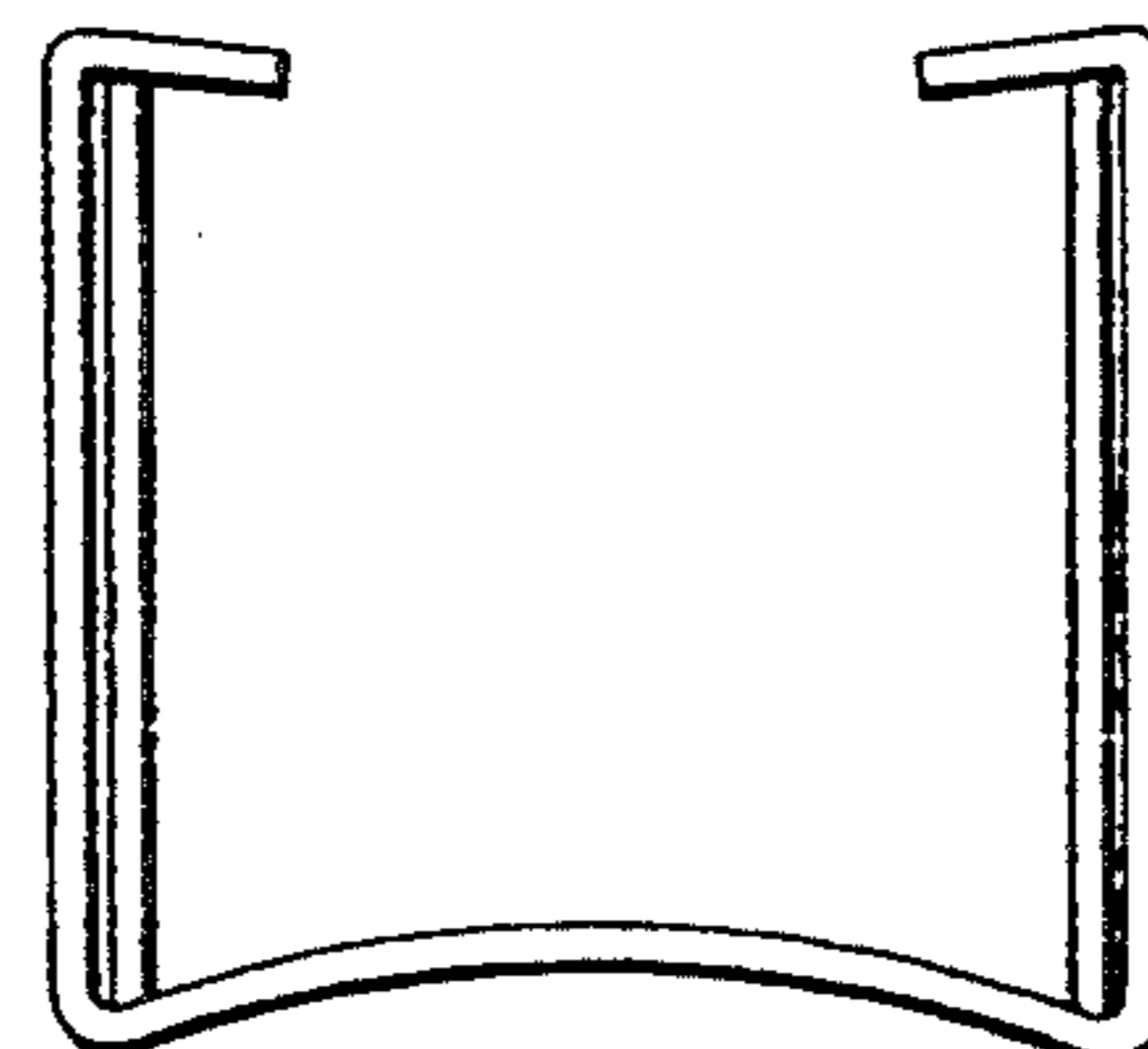

FIG. 9

