



US00D359657S

United States Patent [19]

[11] Patent Number: **Des. 359,657**

Davidson et al.

[45] Date of Patent: **** Jun. 27, 1995**

[54] **BOTTLE HANDLE WITH SUPPORT BOSSES**

[76] Inventors: **Jimmy W. Davidson**, 6660 Upper Afton Rd., Woodbury, Minn. 55125;
Wendall L. Carroll, 4134 - 40th Ave. S., Minneapolis, Minn. 55406

[**] Term: **14 Years**

[21] Appl. No.: **21,410**

[22] Filed: **Apr. 15, 1994**

[52] U.S. Cl. **D7/622**

[58] Field of Search **D7/619, 622; D9/455; 215/100 A; 220/737, 741-742; 294/27.1, 31.2, 32-33**

2,801,743	8/1957	Geen .	
4,602,723	7/1986	DeMars	220/85 H
4,936,614	6/1990	Russell	294/27.1
4,993,675	2/1991	Walker	248/311.2
5,013,074	5/1991	Galle	294/33

Primary Examiner—Terry A. Wallace
Attorney, Agent, or Firm—Westman, Champlin & Kelly

[57] CLAIM

The ornamental design for a bottle handle with support bosses, as shown and described.

DESCRIPTION

FIG. 1 is a top prespective view of a bottle handle with support bosses embodying our new design; FIG. 2 is a top plan view thereof; FIG. 3 is a front elevational view thereof; FIG. 4 is a left side elevational view thereof, the opposite side view being a mirror image thereof; FIG. 5 is a rear elevational view thereof; and, FIG. 6 is a bottom plan view thereof.

[56] References Cited

U.S. PATENT DOCUMENTS

D. 149,933	6/1948	Bushman	D7/622
D. 265,159	6/1982	La Barbera	D7/622
D. 292,160	10/1987	Thomas	D7/622

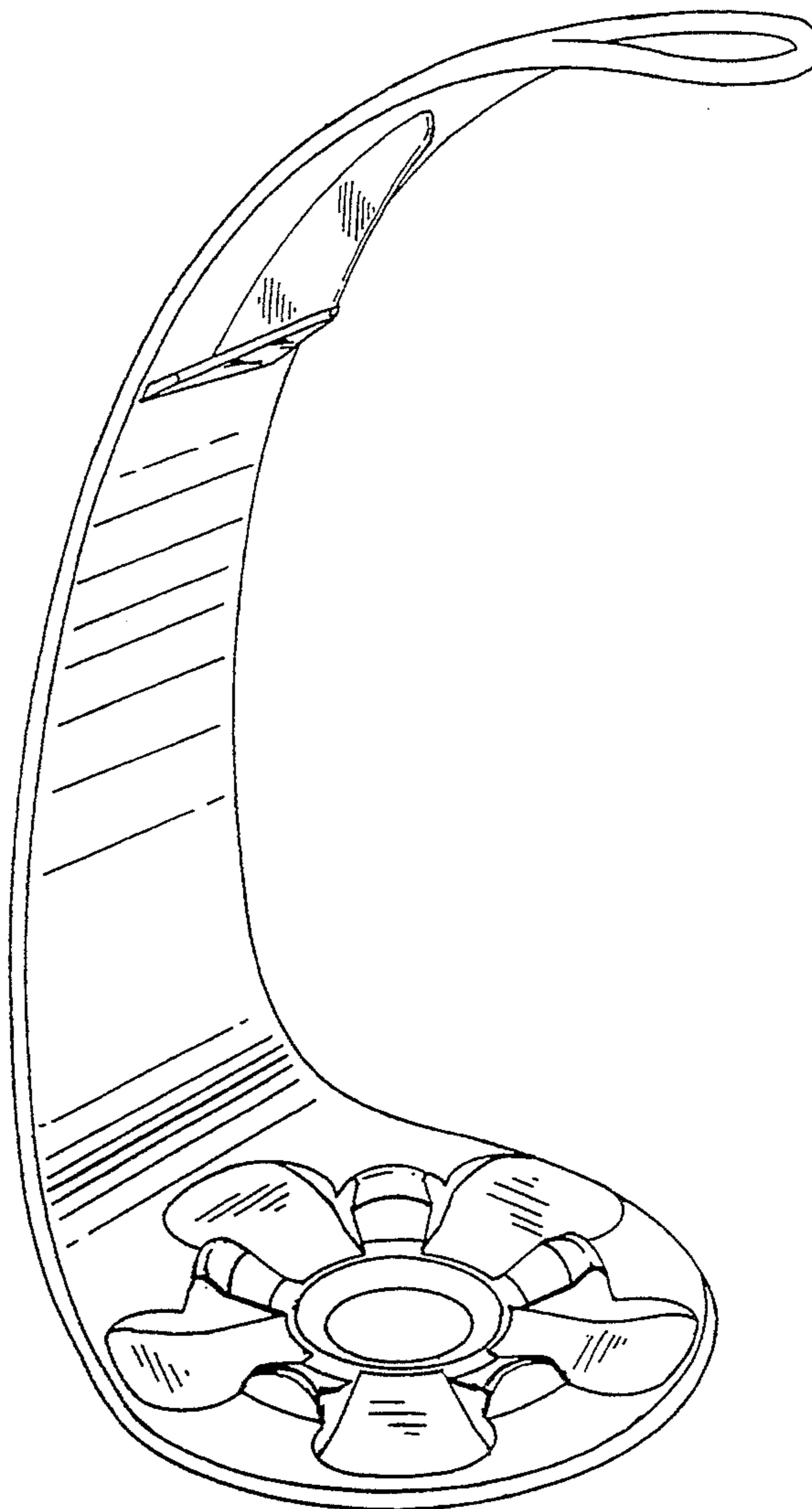

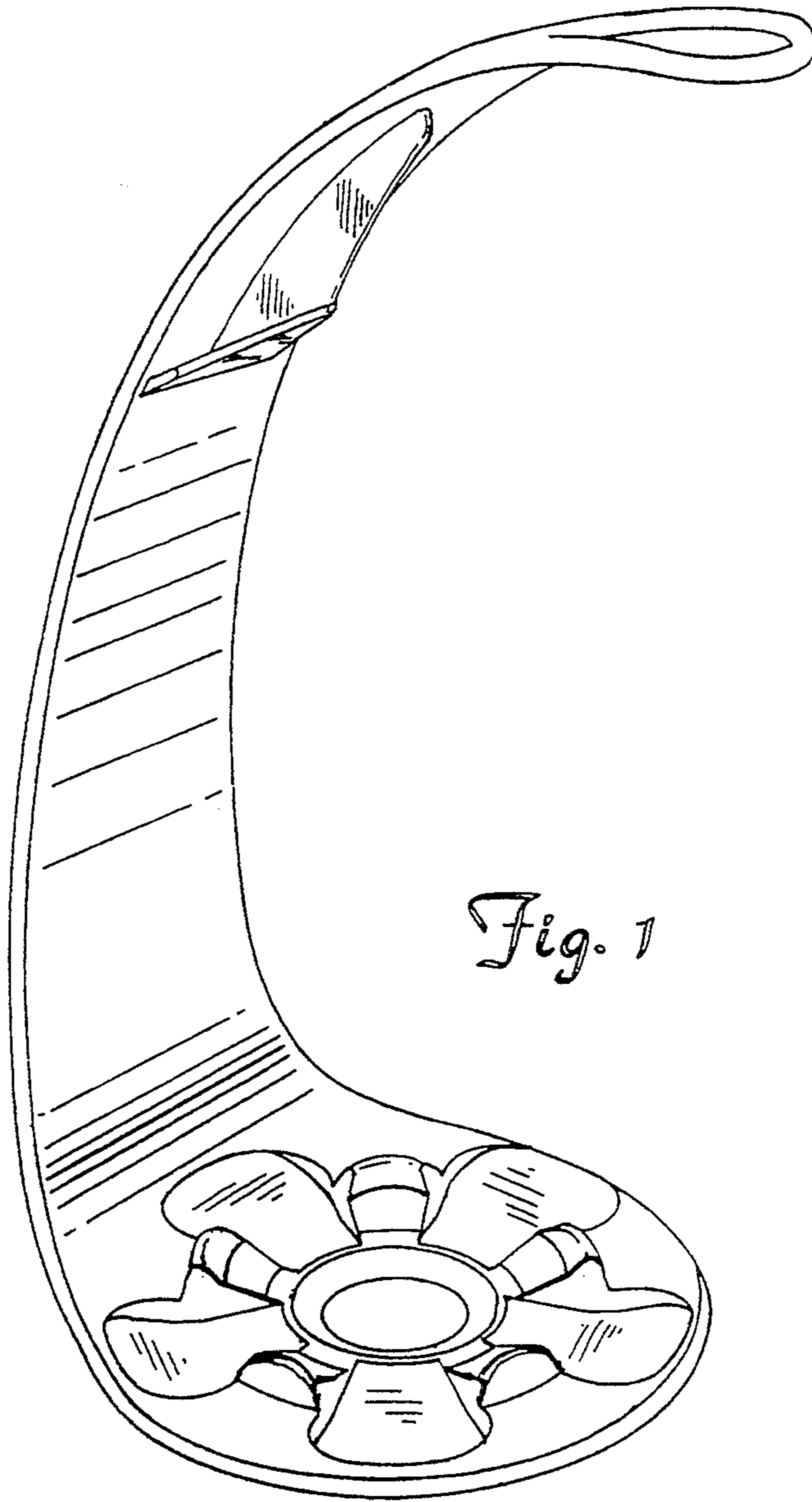

Fig. 1

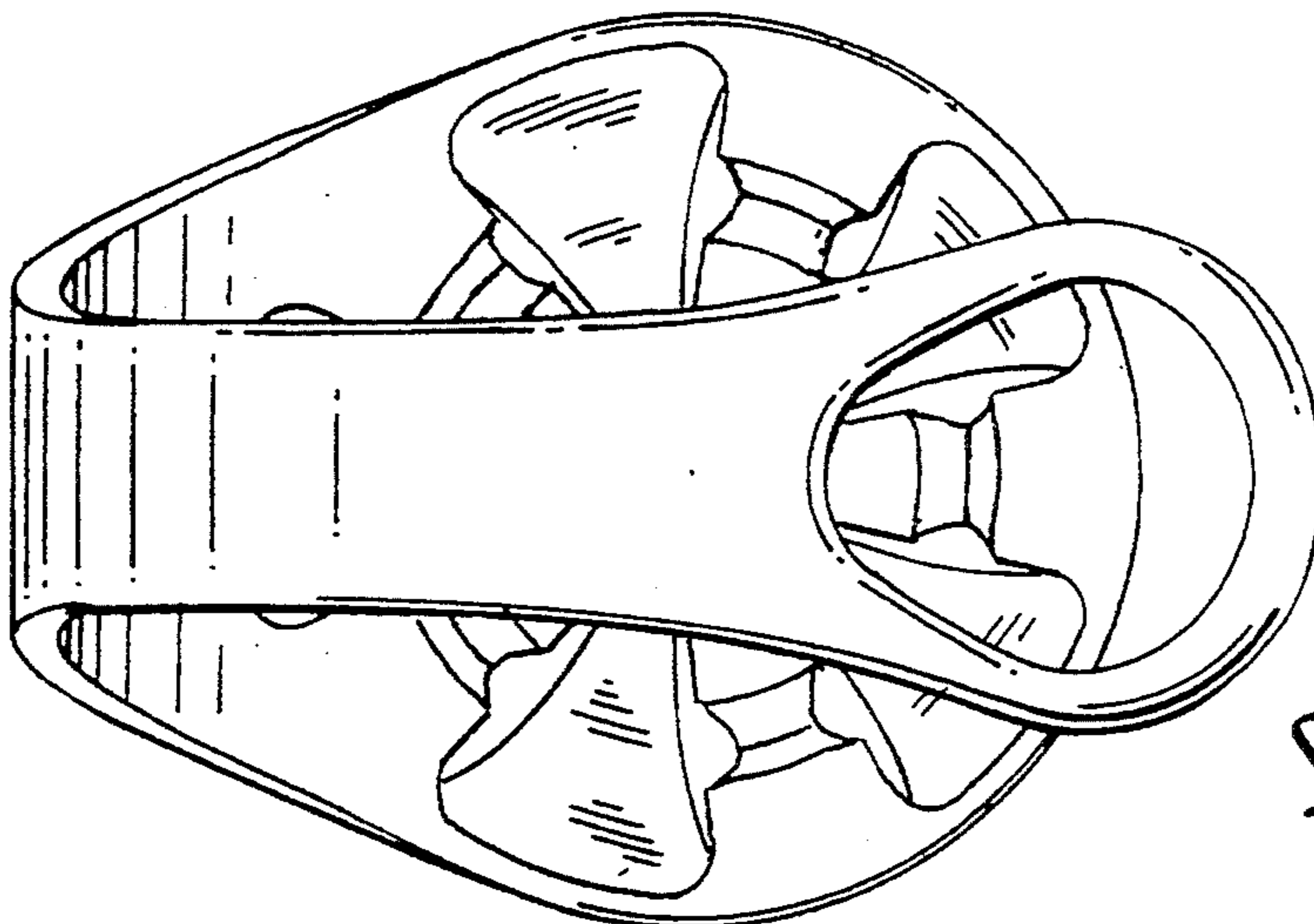

Fig. 2

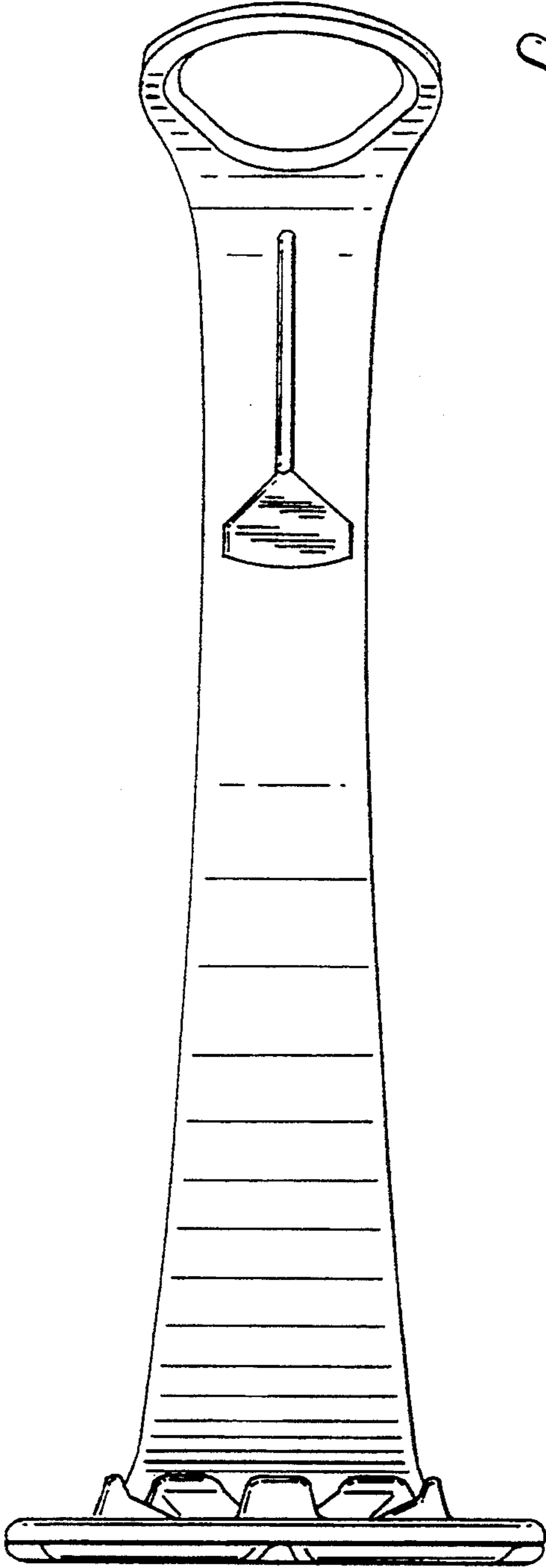

Fig. 3

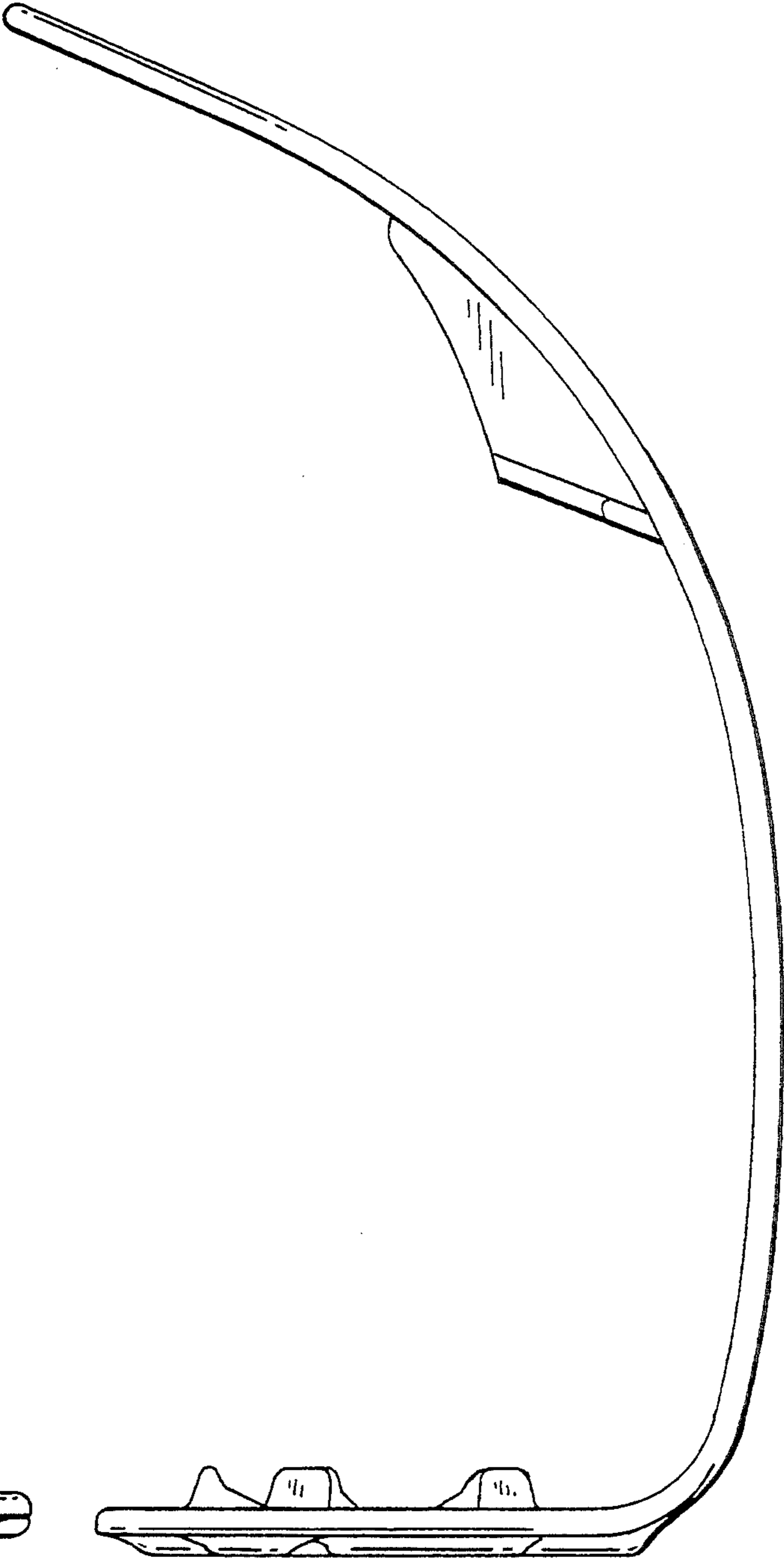

Fig. 4

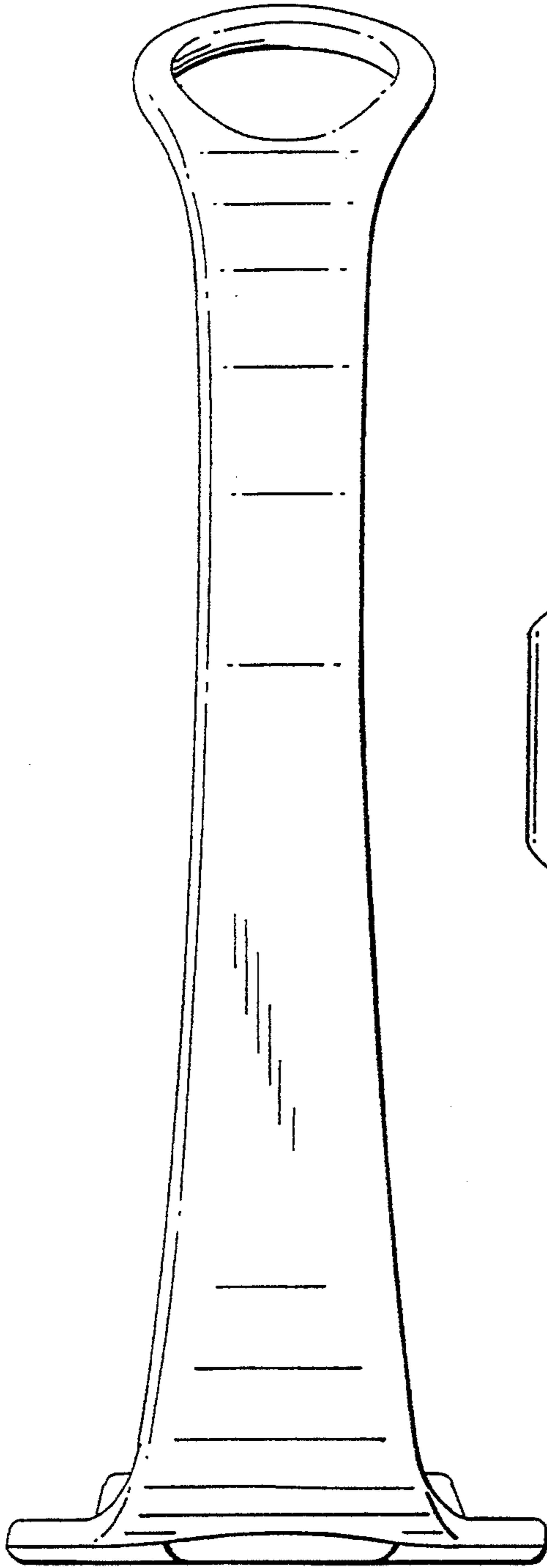

Fig. 5

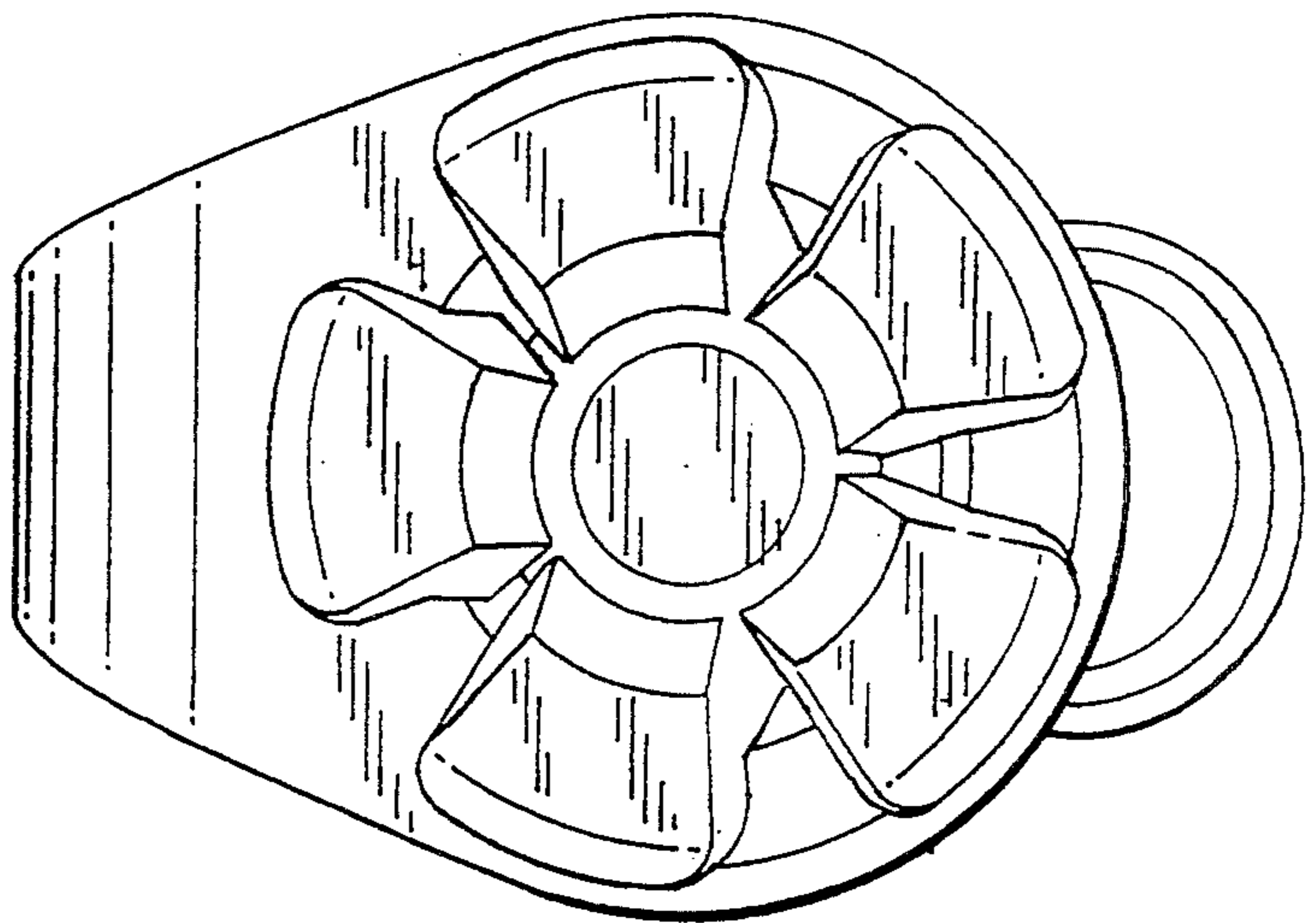

Fig. 6