



US00D359594S

United States Patent [19]

[11] Patent Number: **Des. 359,594**

Macri

[45] Date of Patent: **** Jun. 20, 1995**

[54] **PET FEEDING STATION**
[76] Inventor: **Joan C. Macri**, 355 Cypress St., Fall River, Mass. 02720

4,263,876 4/1981 Scott 119/62
4,335,679 6/1982 Carlin 119/51.5
5,054,431 10/1991 Coviello 119/61
5,222,990 6/1993 Elliott 119/61
5,349,925 9/1994 Zerato et al. 119/62

[**] Term: **14 Years**

FOREIGN PATENT DOCUMENTS

[21] Appl. No.: **19,391**

1397126 6/1975 United Kingdom 119/62
2119621 11/1983 United Kingdom 119/61
2220835 11/1990 United Kingdom 119/61

[22] Filed: **Mar. 2, 1994**

[52] U.S. Cl. **D30/133; D7/553**

[58] Field of Search D30/121, 122, 129, 130,
D30/131, 132, 133; 119/51.5, 61-62; D7/550,
553

Primary Examiner—Cathy Anne MacCormac
Attorney, Agent, or Firm—Robert J. Doherty

[57] CLAIM

The ornamental design for a pet feeding station, as shown and described

[56] References Cited

U.S. PATENT DOCUMENTS

D. 229,073 11/1973 Brickel D30/130
D. 253,627 12/1979 Adamson D7/550
D. 259,669 6/1981 Peterson D30/130
D. 270,672 9/1983 Zelinger D30/130
D. 288,374 2/1987 Akeda D7/550
D. 318,985 8/1991 Szablak et al. D30/133
D. 326,962 6/1992 Mowry et al. D30/130
445,443 1/1891 Everhard D7/698
3,121,419 2/1964 Gillespie 119/62
3,176,656 4/1965 Bates 119/62

DESCRIPTION

FIG. 1 is a front perspective view showing my new design for a pet feeding station;
FIG. 2 is a top plan view thereof;
FIG. 3 is a bottom plan view thereof;
FIG. 4 is a front elevational view thereof;
FIG. 5 is a rear elevational view thereof;
FIG. 6 is a left side elevational view thereof; and,
FIG. 7 is a right side elevational view thereof.

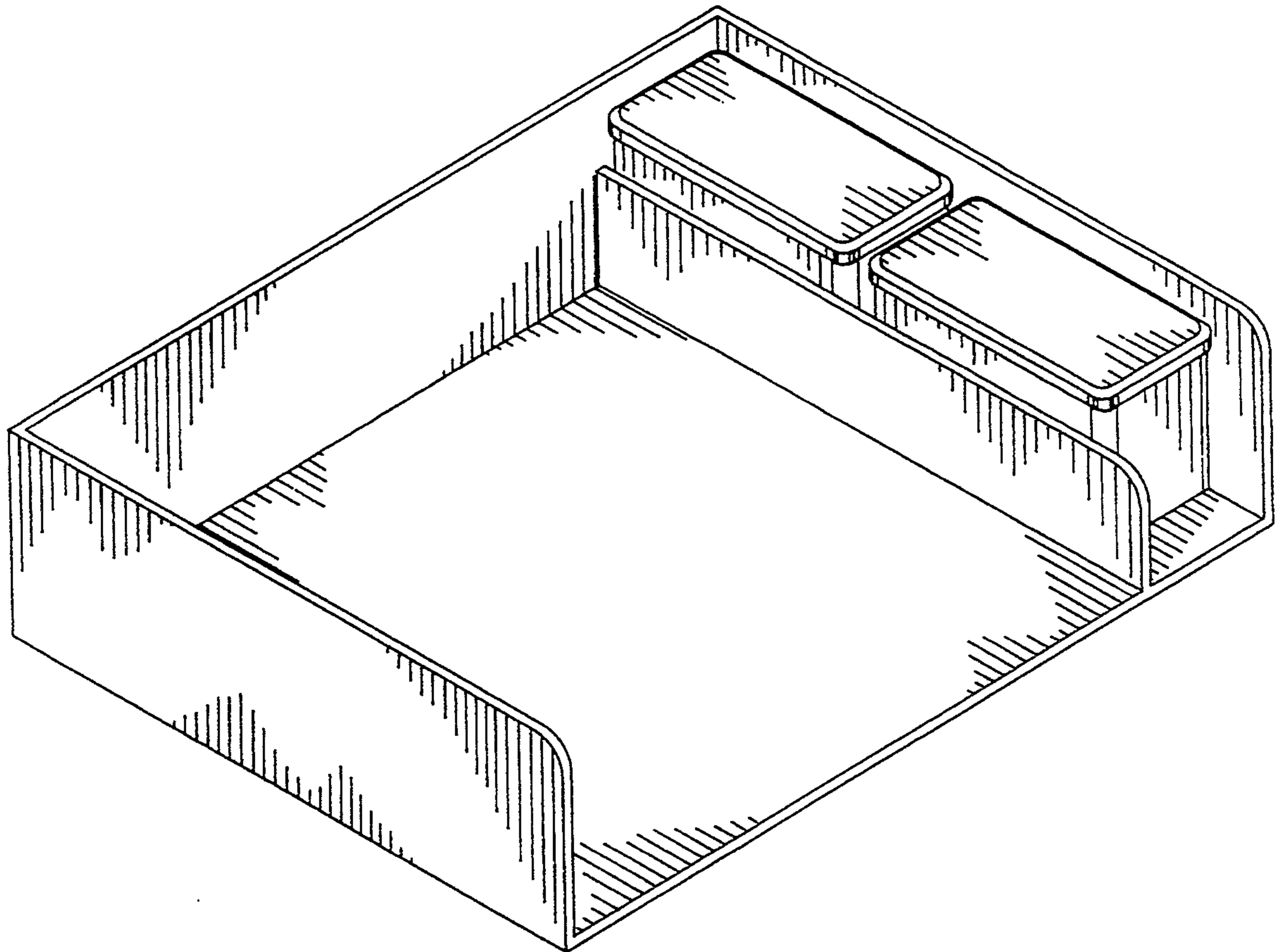

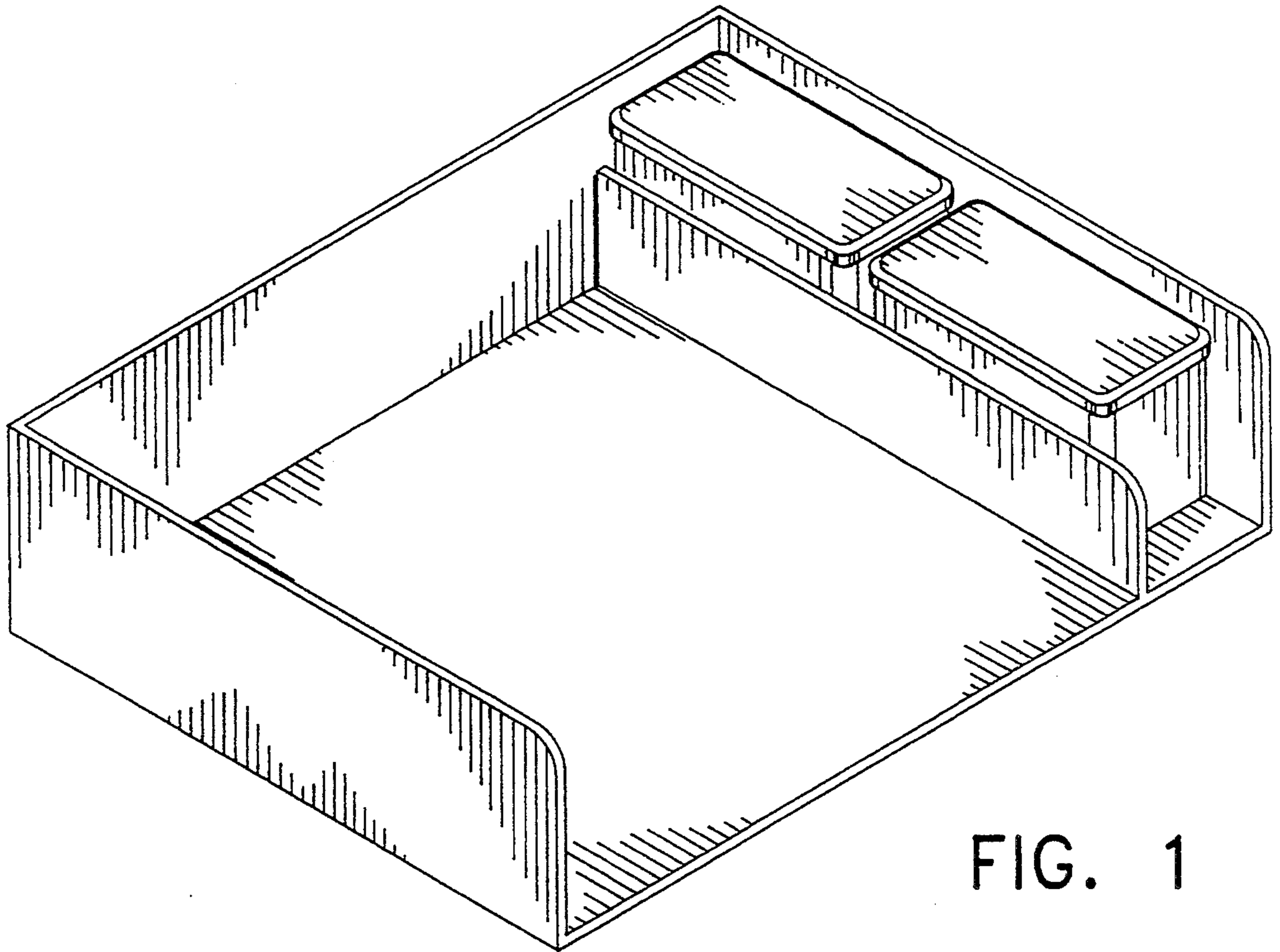

FIG. 1

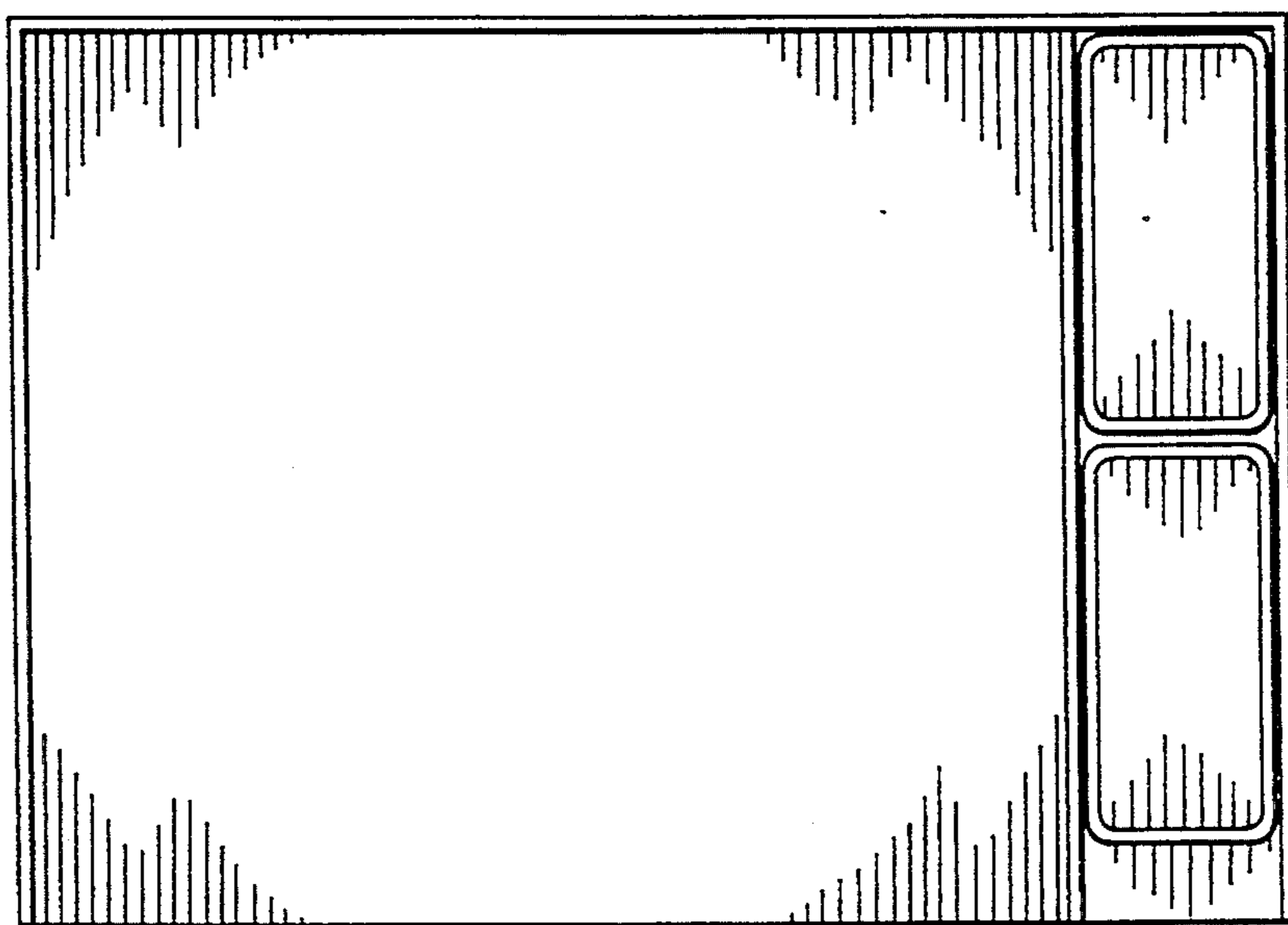

FIG. 2

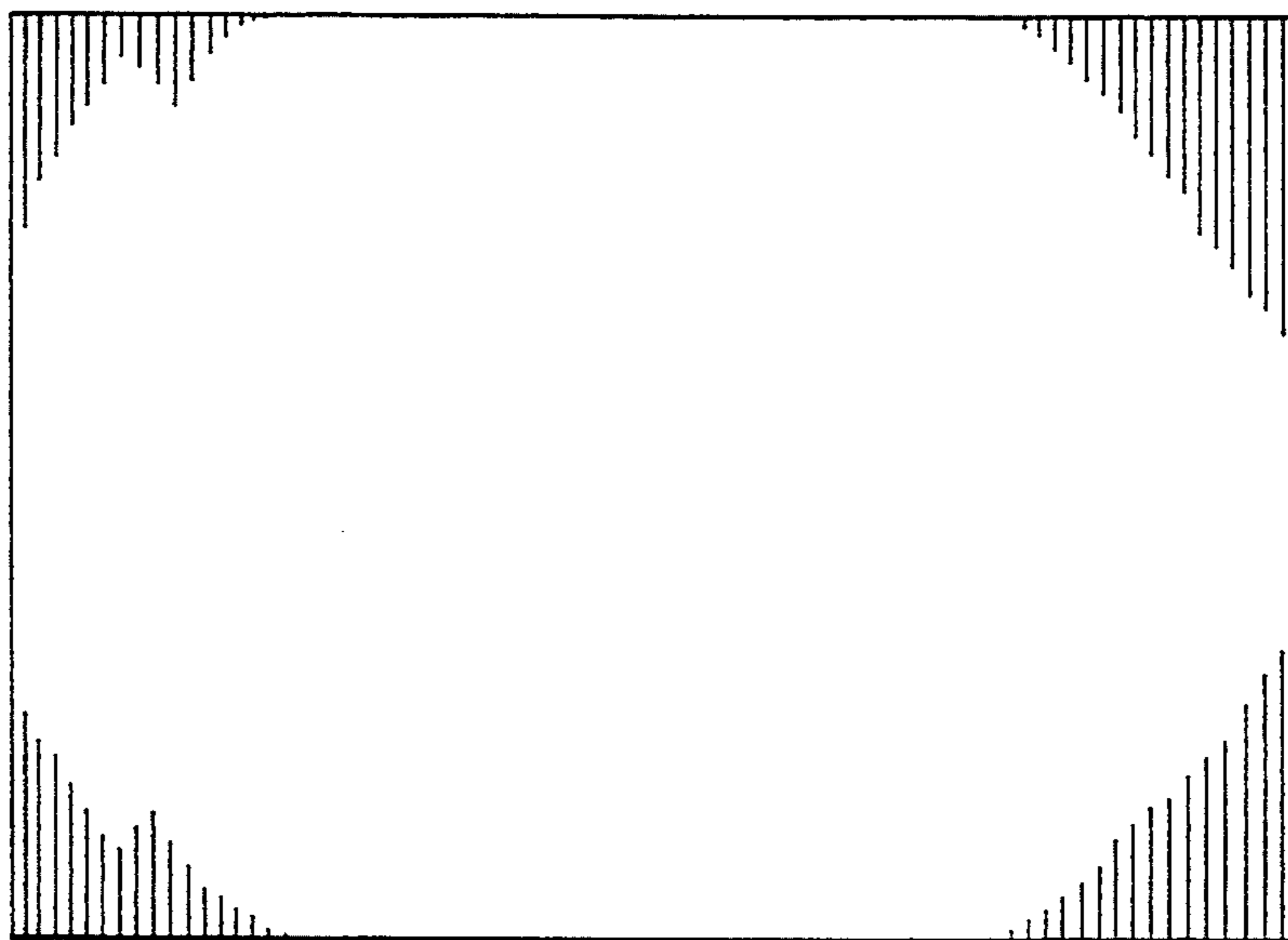

FIG. 3

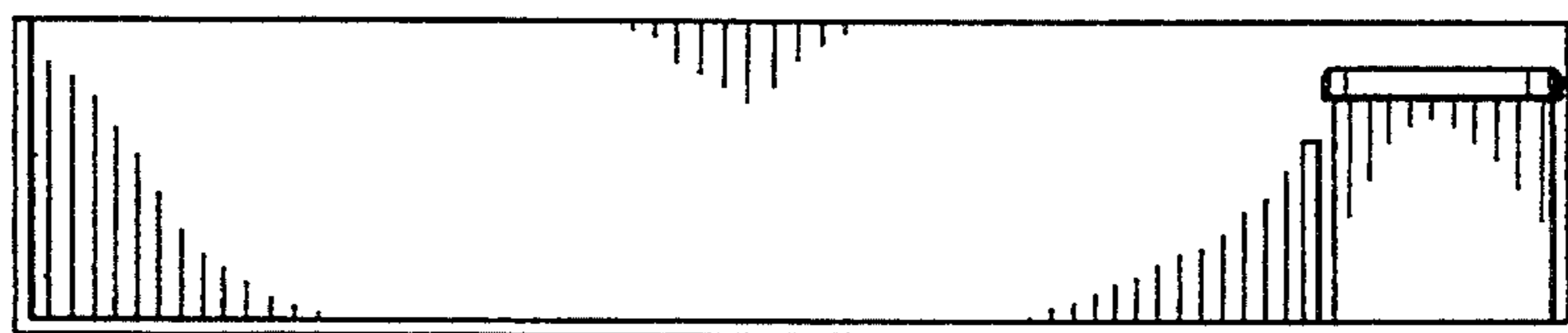

FIG. 4

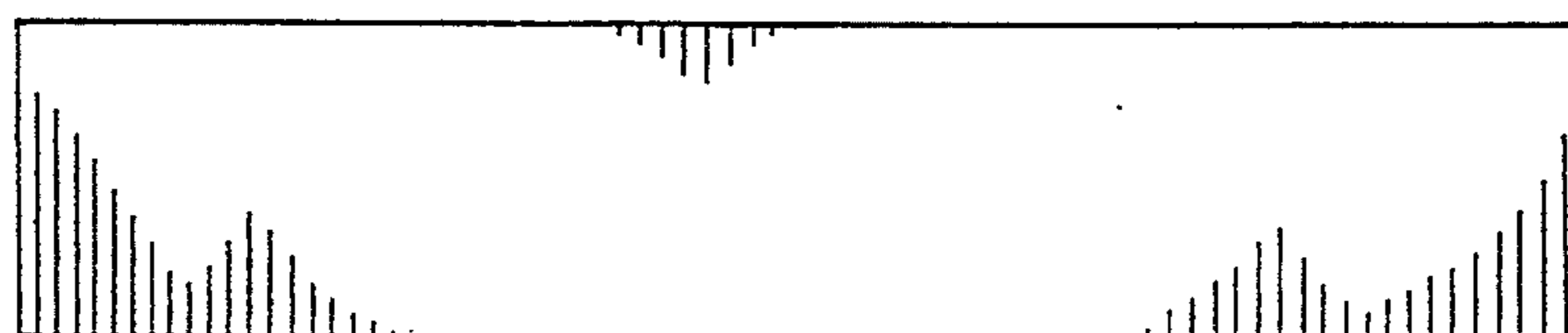

FIG. 5

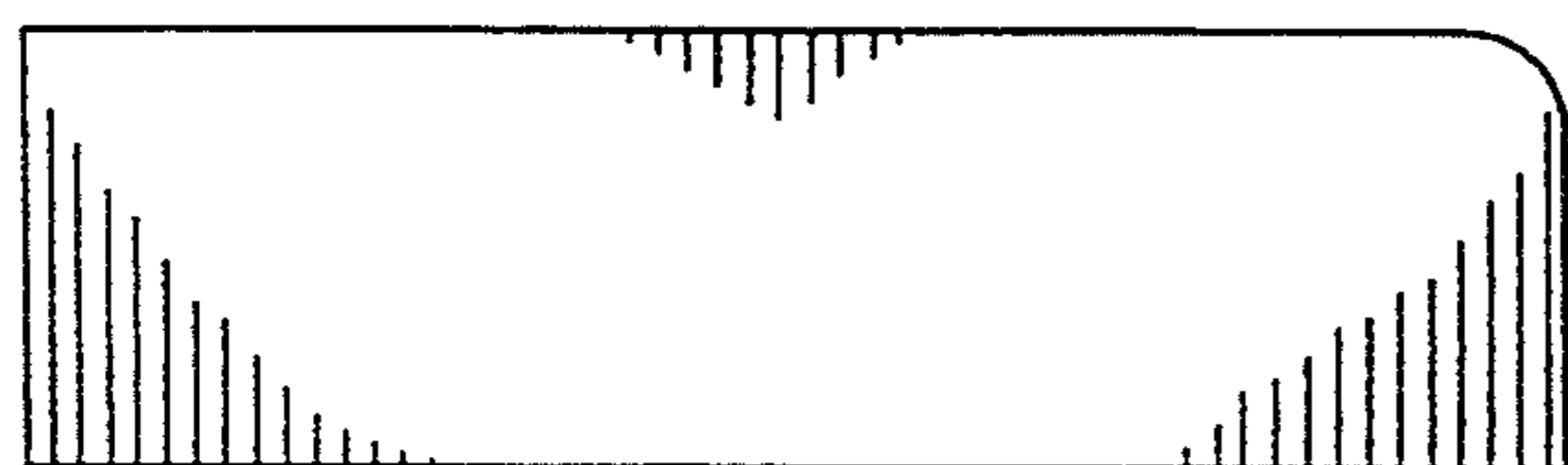

FIG. 6

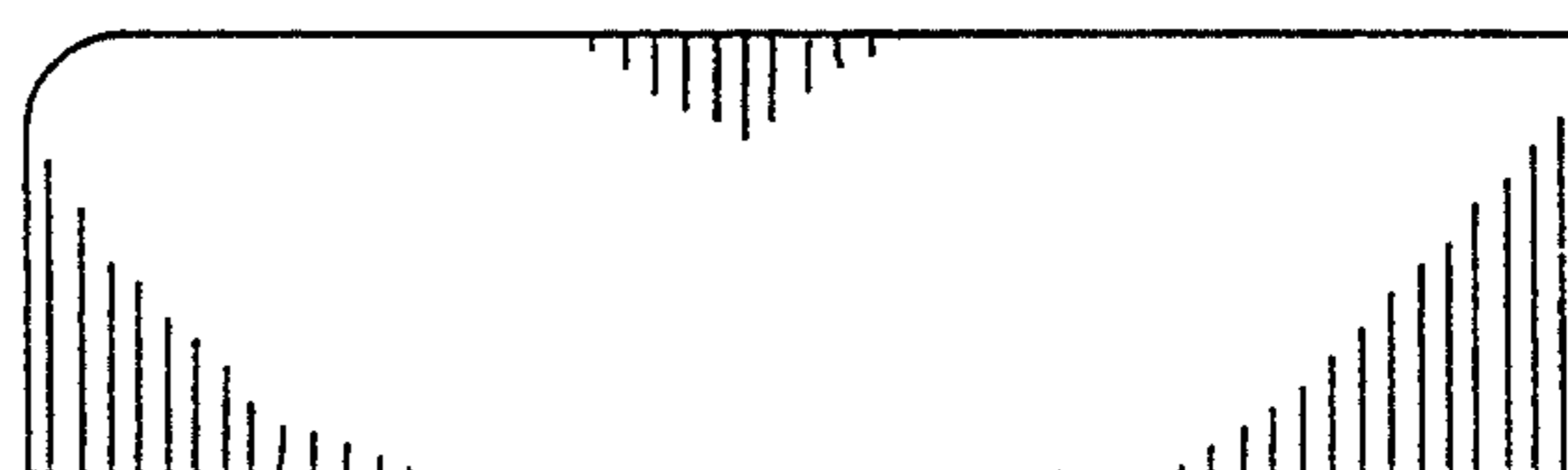

FIG. 7