



US00D359501S

United States Patent [19]

[11] Patent Number: Des. 359,501

Hamamura

[45] Date of Patent: ** Jun. 20, 1995

[54] 35 MM CAMERA

[75] Inventor: Toshihiro Hamamura, Tokyo, Japan

[73] Assignee: Asahi Kogaku Kogyo Kabushiki Kaisha, Tokyo, Japan

[**] Term: 14 Years

[21] Appl. No.: 25,185

[22] Filed: Jul. 6, 1994

[30] Foreign Application Priority Data

Jan. 6, 1994 [JP] Japan 6-54

[52] U.S. Cl. D16/209; D16/212

[58] Field of Search D16/200, 201, 203, 204, D16/208, 209, 216-218; 354/126, 149.11, 187, 202, 288

[56] References Cited

U.S. PATENT DOCUMENTS

D. 263,056	2/1982	Hattori	D16/212
D. 287,733	1/1987	Ago et al.	D16/212
D. 323,336	1/1992	Moro et al.	D16/209
4,556,304	12/1985	Fukuda	354/288

OTHER PUBLICATIONS

35 mm Photography, Jan. 1986, p. 59 (Fuji DL200).

Primary Examiner—B. J. Bullock

Assistant Examiner—Adir Aronovich

Attorney, Agent, or Firm—Sughrue, Mion, Zinn, Macpeak & Seas

[57] CLAIM

The ornamental design for a 35 mm camera, as shown.

DESCRIPTION

FIG. 1 is a front perspective view of 35 mm camera showing my new design, with the lens cover open and the lens at least partially retracted;

FIG. 2 is a front view of the camera of FIG. 1;

FIG. 3 is a top view of the camera of FIG. 1;

FIG. 4 is a left side view of the camera of FIG. 1;

FIG. 5 is a right side view of the camera of FIG. 1;

FIG. 6 is a rear view of the camera of FIG. 1;

FIG. 7 is a bottom view of the camera of FIG. 1;

FIG. 8 is a perspective view of the camera of FIG. 1 with the lens cover closed;

FIG. 9 is a front view of the camera configuration shown in FIG. 8;

FIG. 10 is a top view of the camera configuration shown in FIG. 8;

FIG. 11 is a left side view of the camera configuration shown in FIG. 8;

FIG. 12 is a right side view of the camera configuration shown in FIG. 8;

FIG. 13 is a bottom view of the camera configuration shown in FIG. 8; and,

FIG. 14 is a perspective view similar to FIG. 1 with the lens extended.

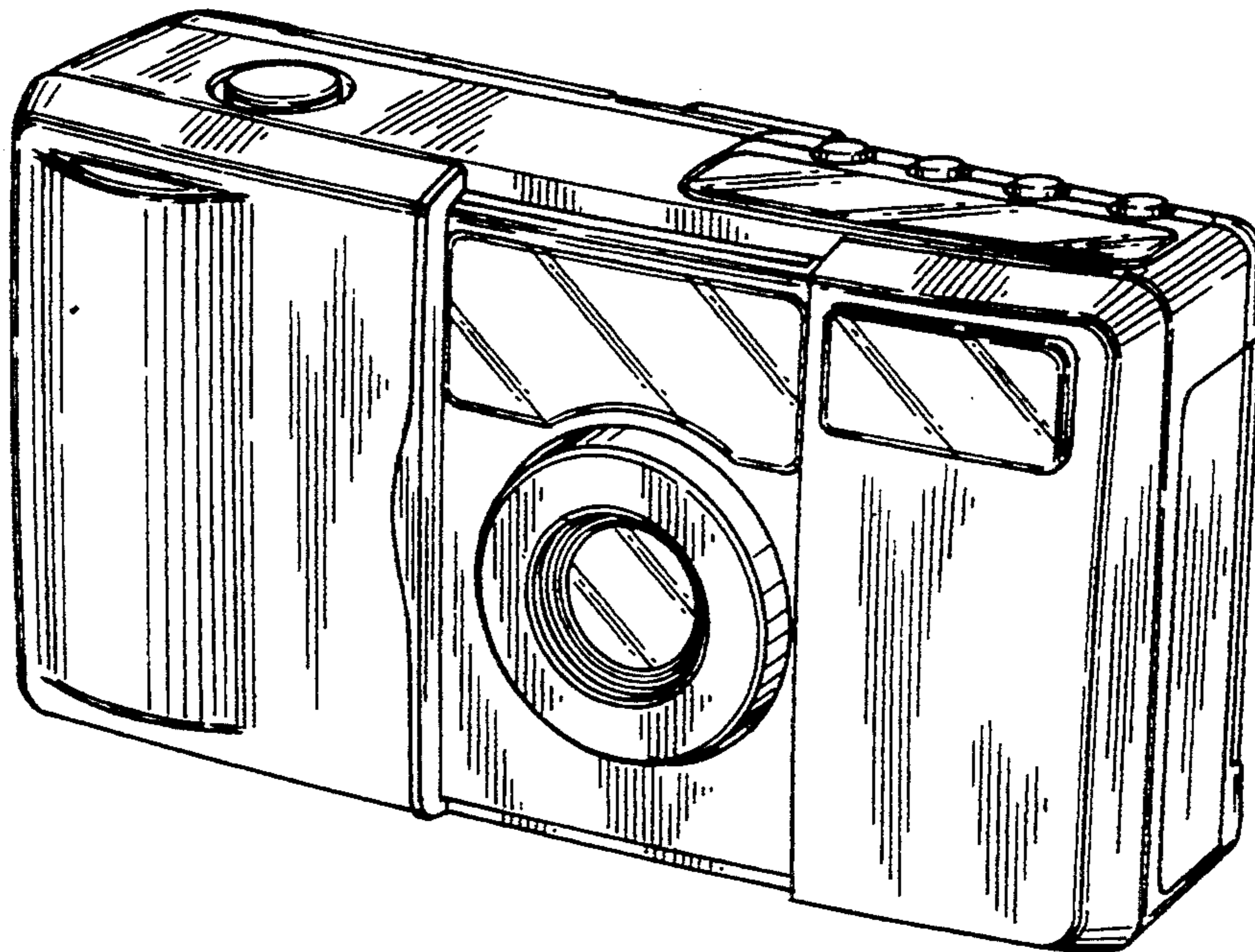

FIG. 1

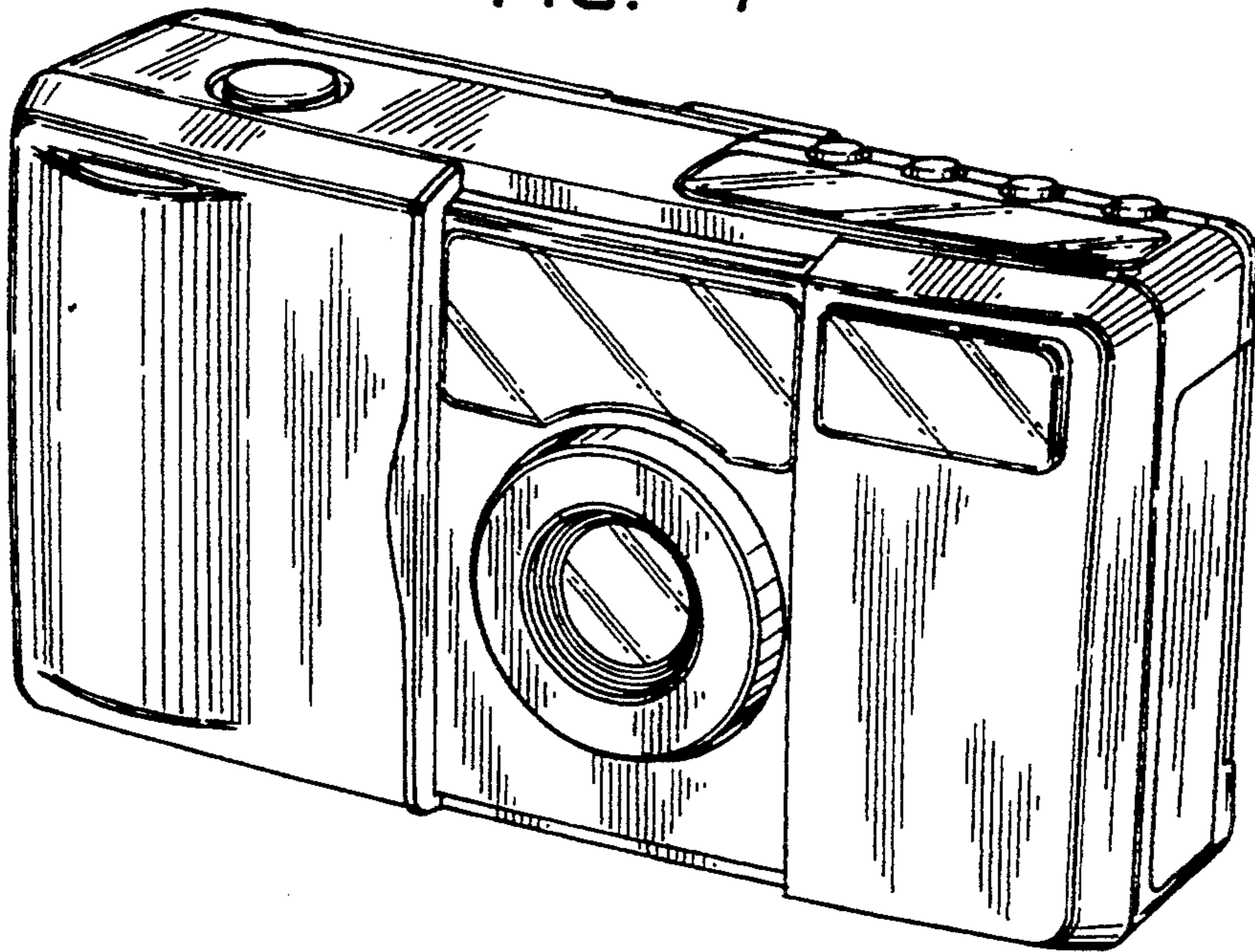

FIG. 2

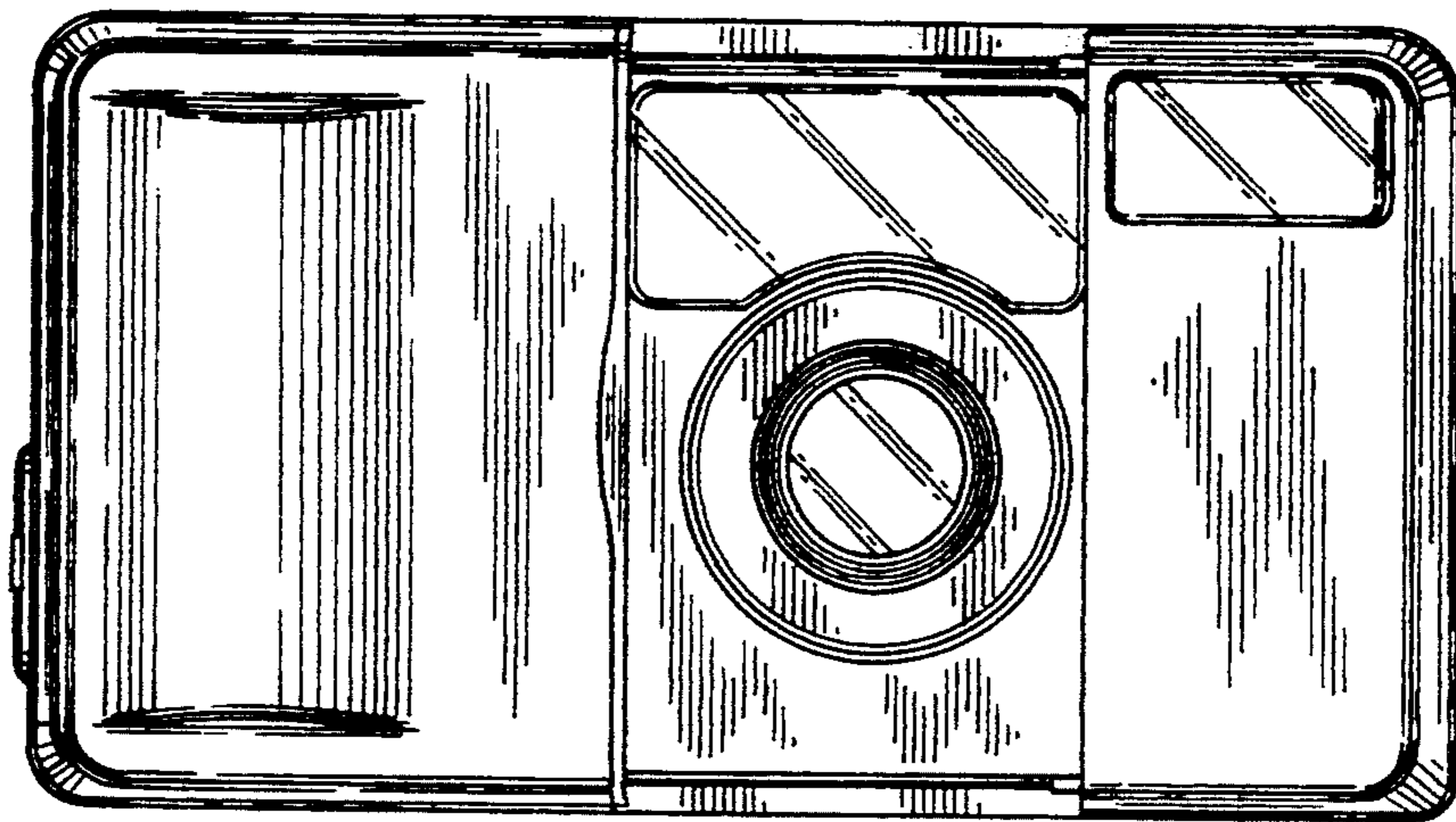

FIG. 3

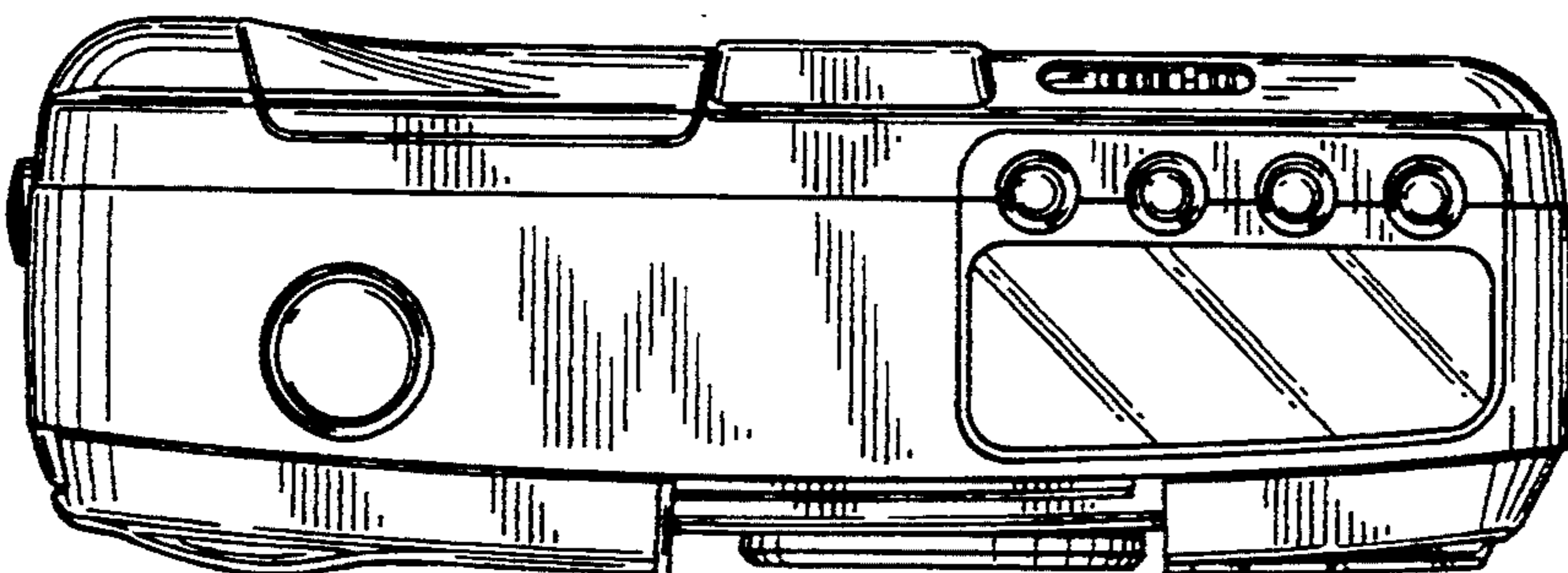

FIG. 4

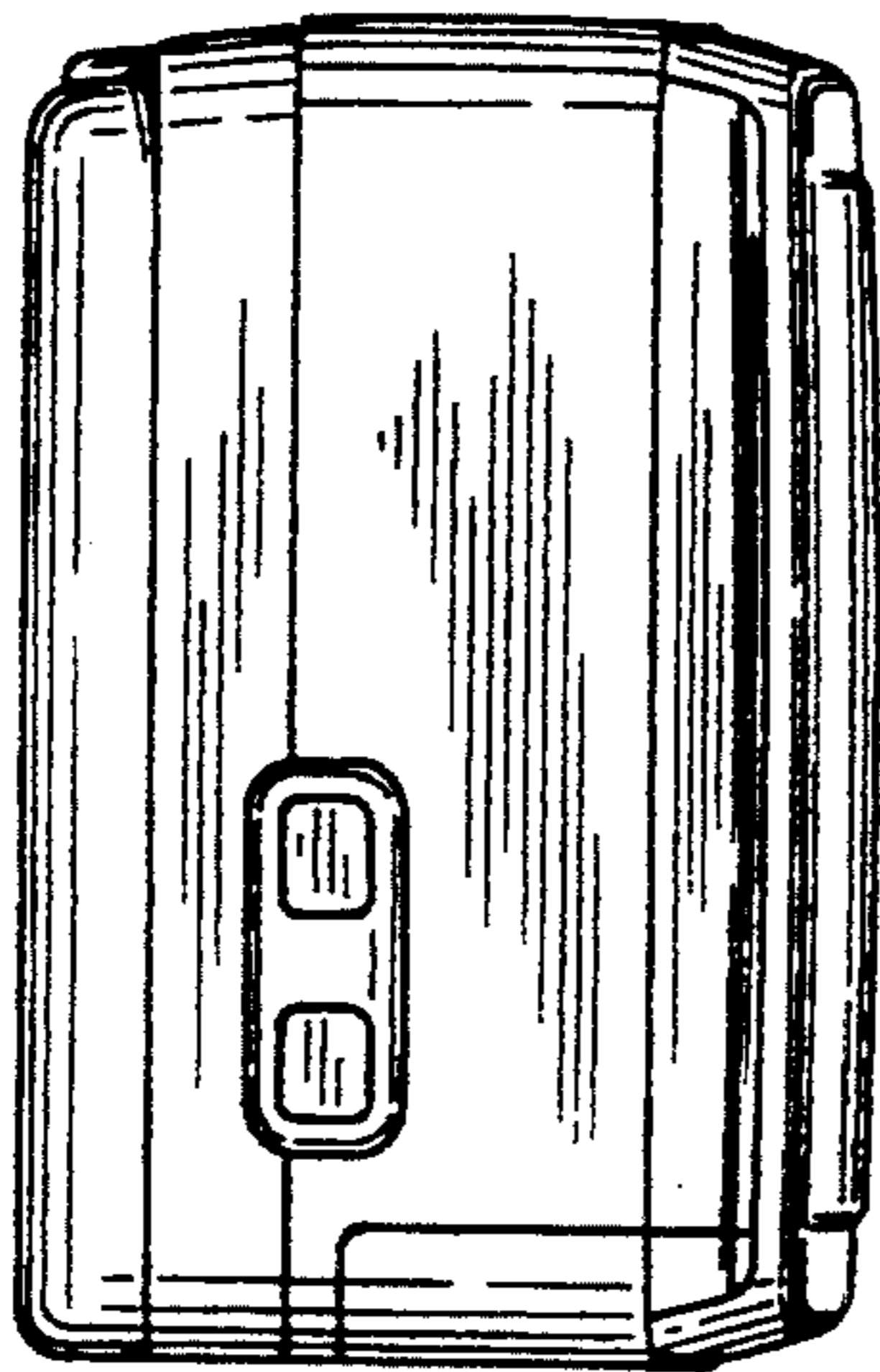

FIG. 5

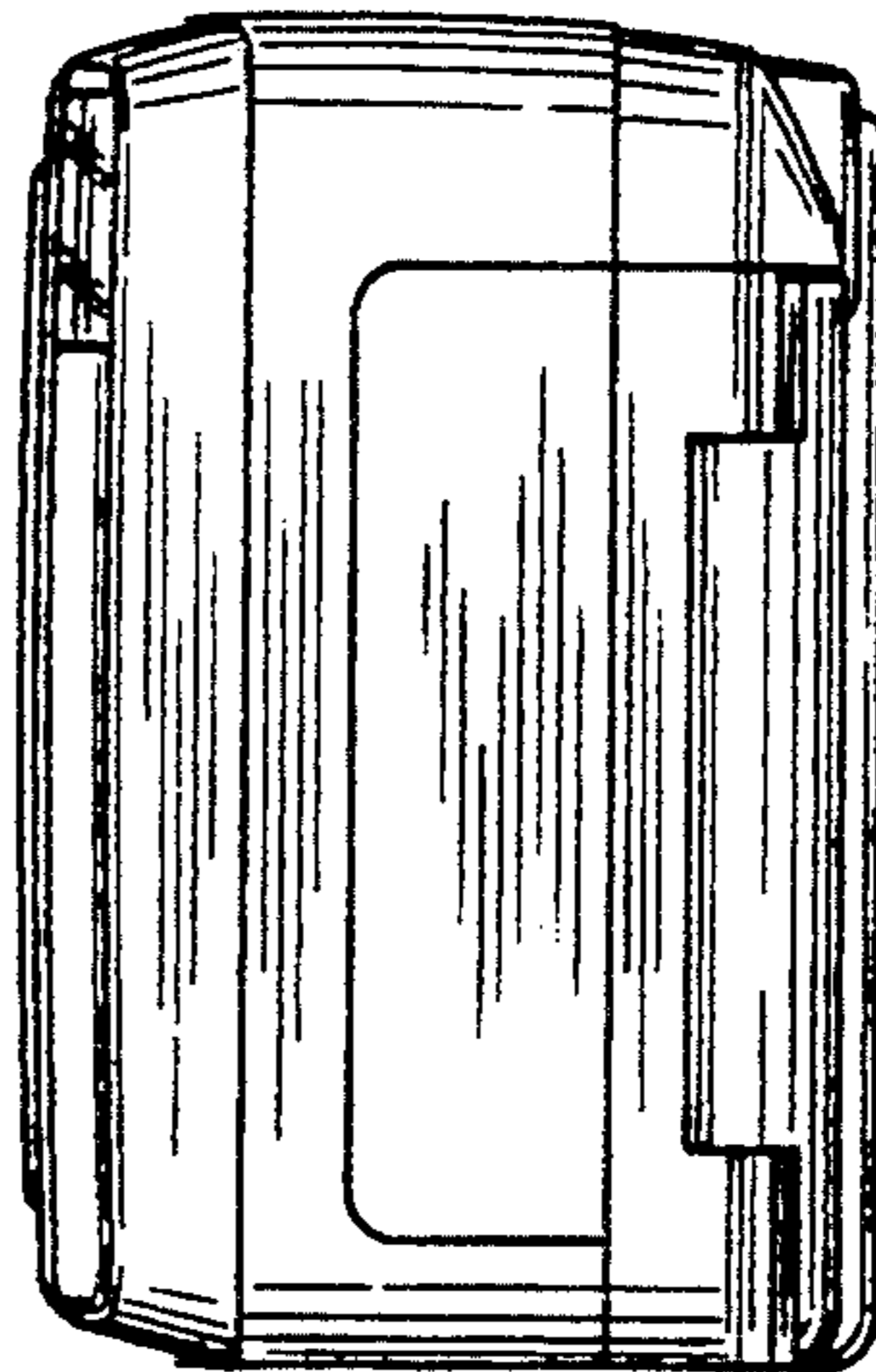

FIG. 6

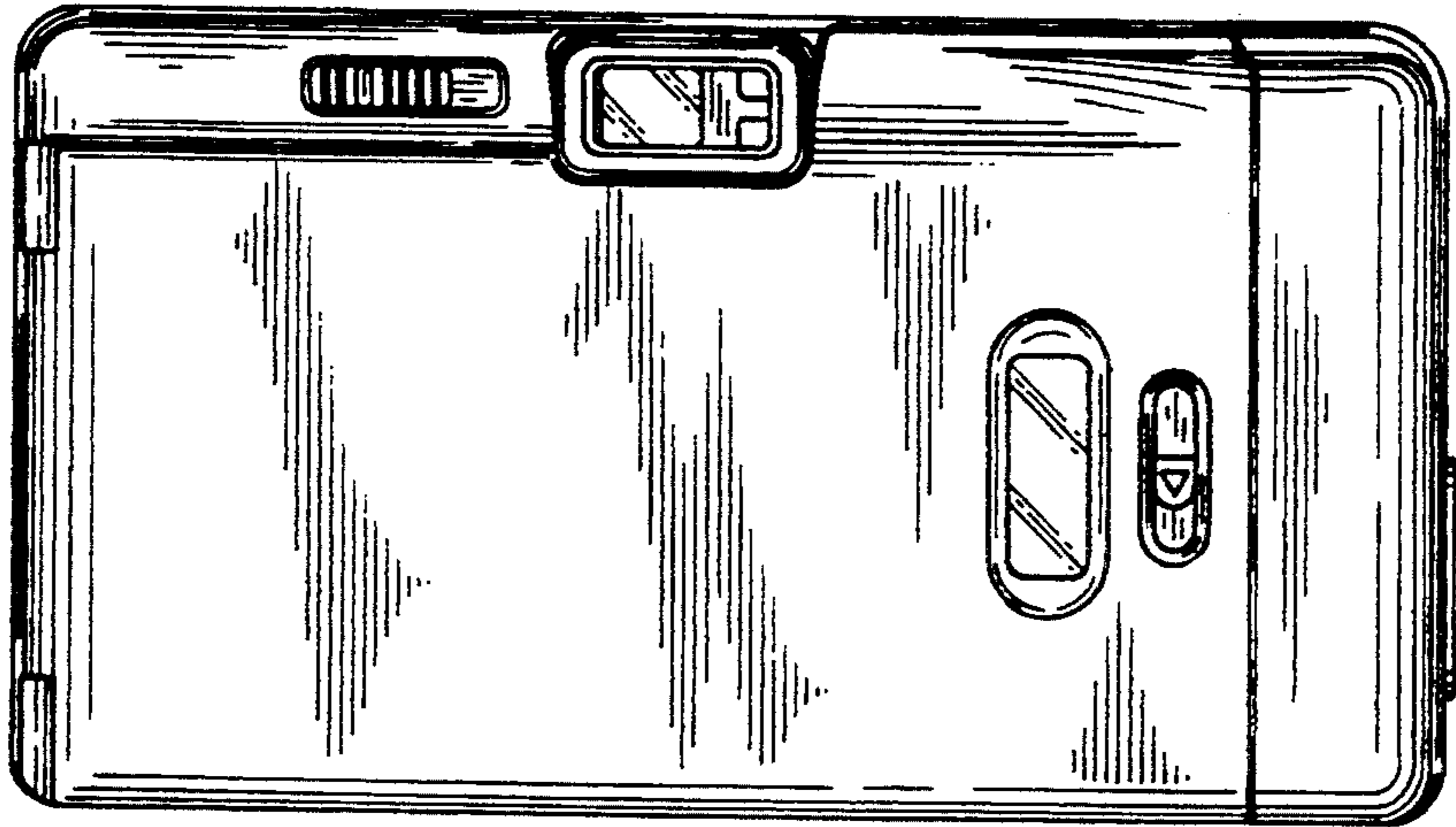

FIG. 7

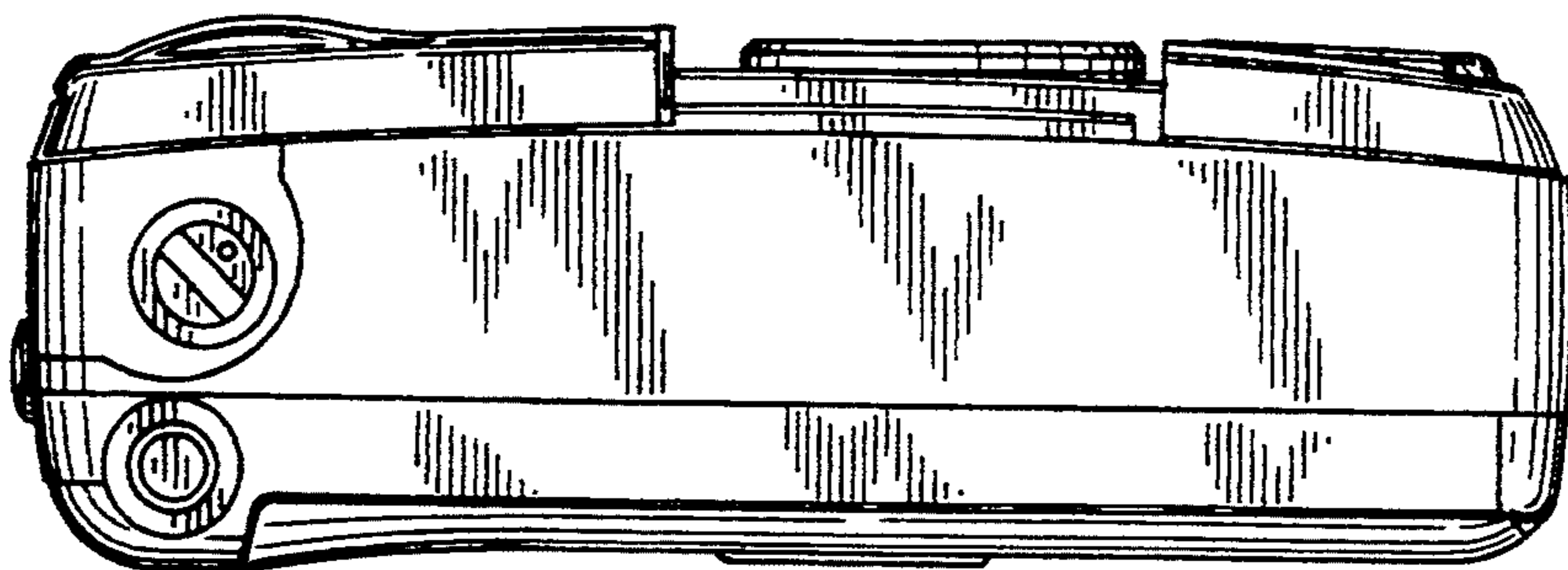

FIG. 8

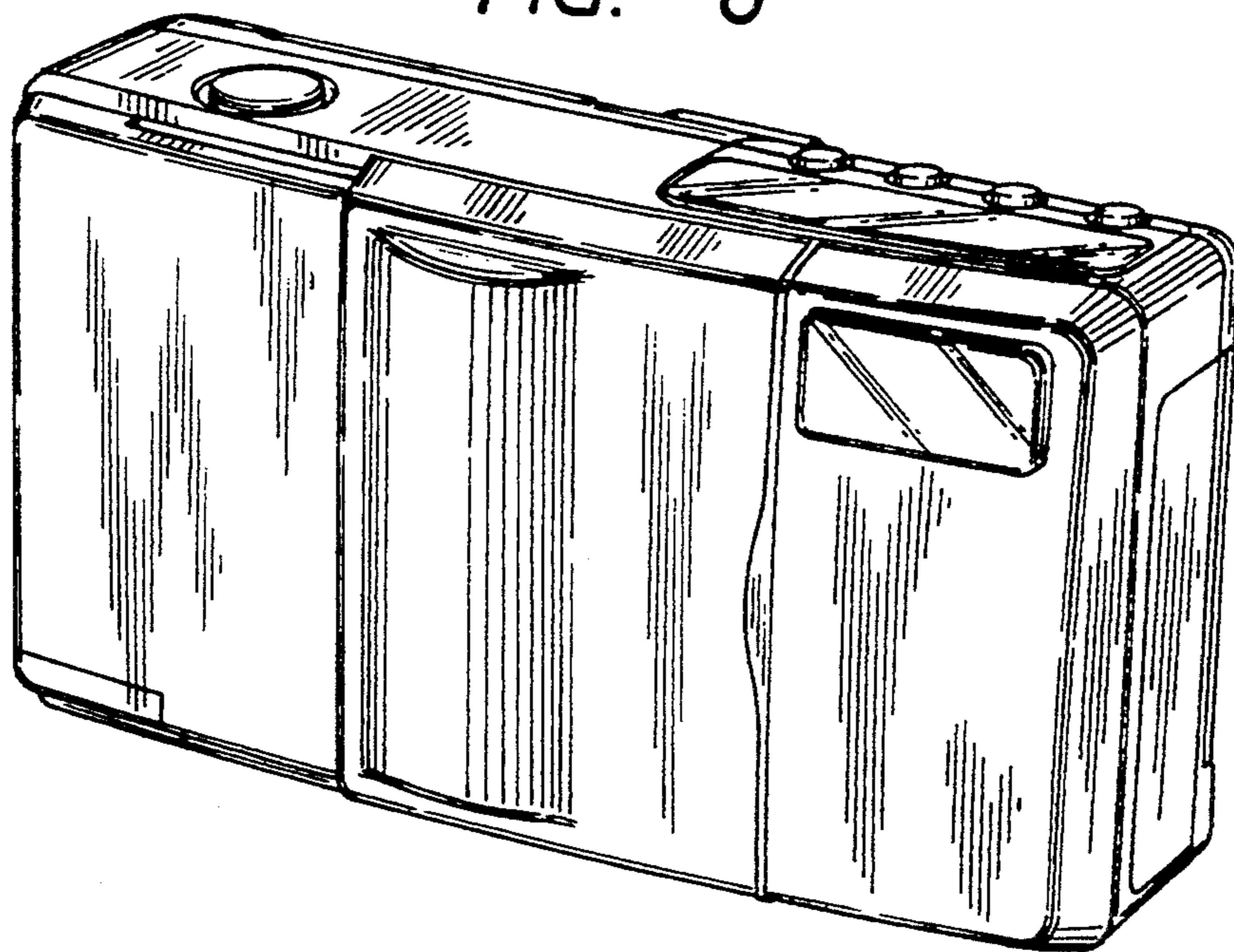

FIG. 9

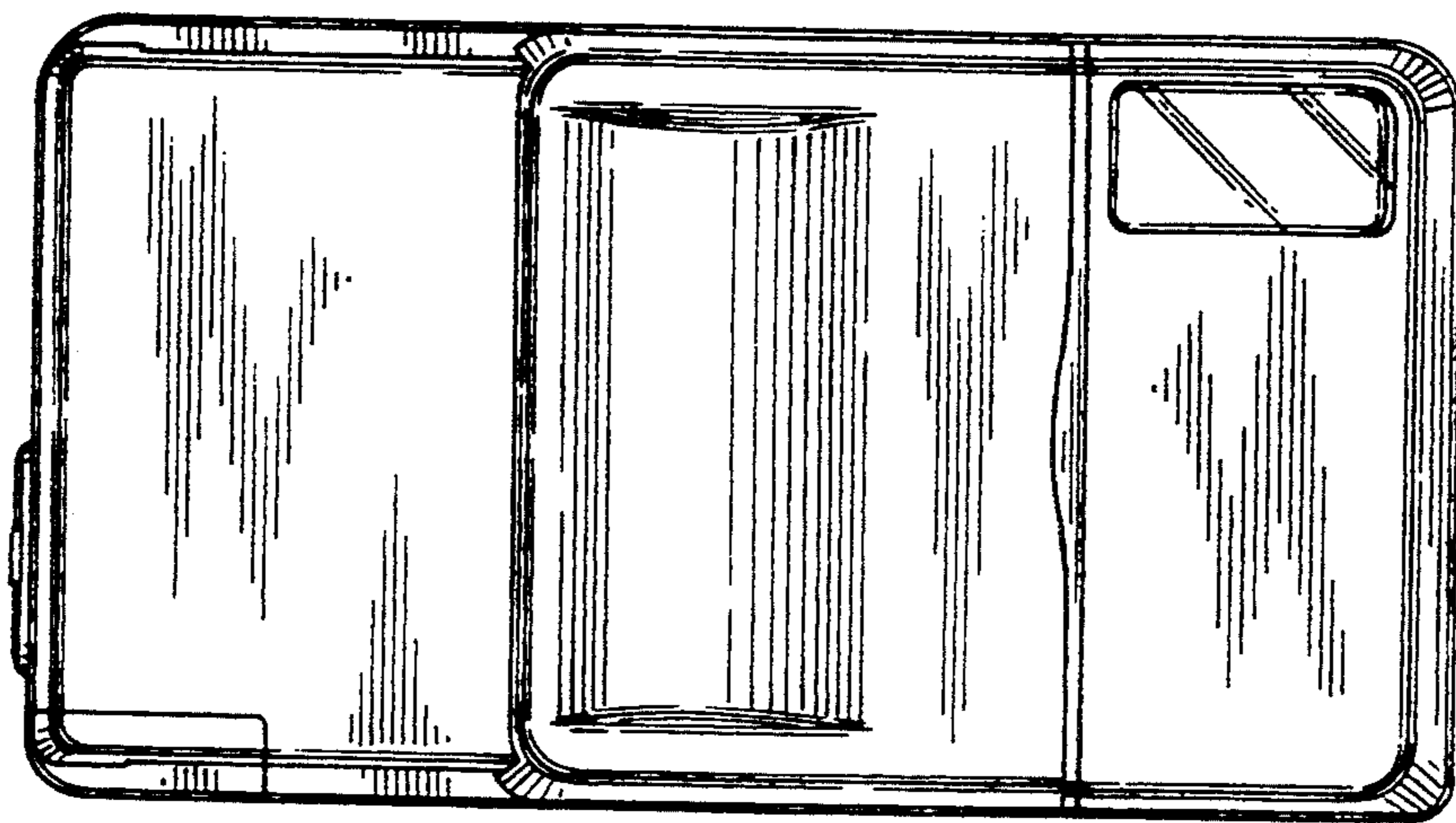

FIG. 10

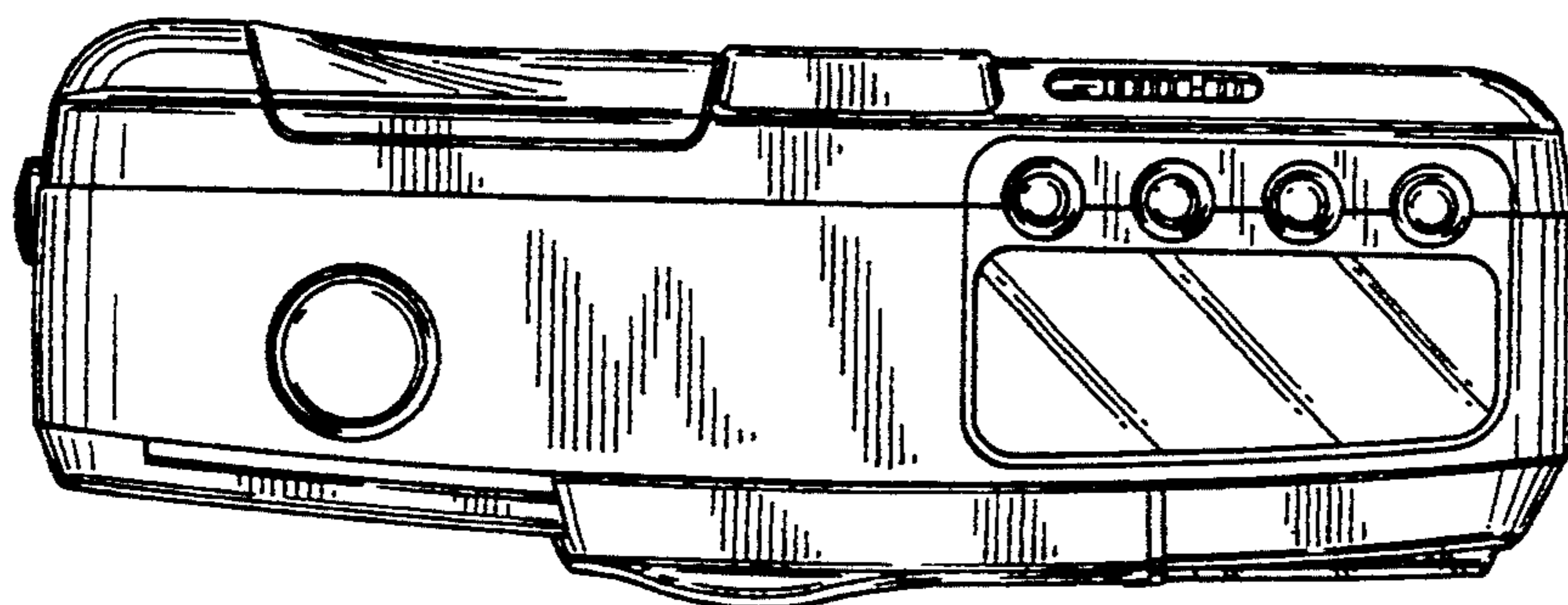

FIG. 11

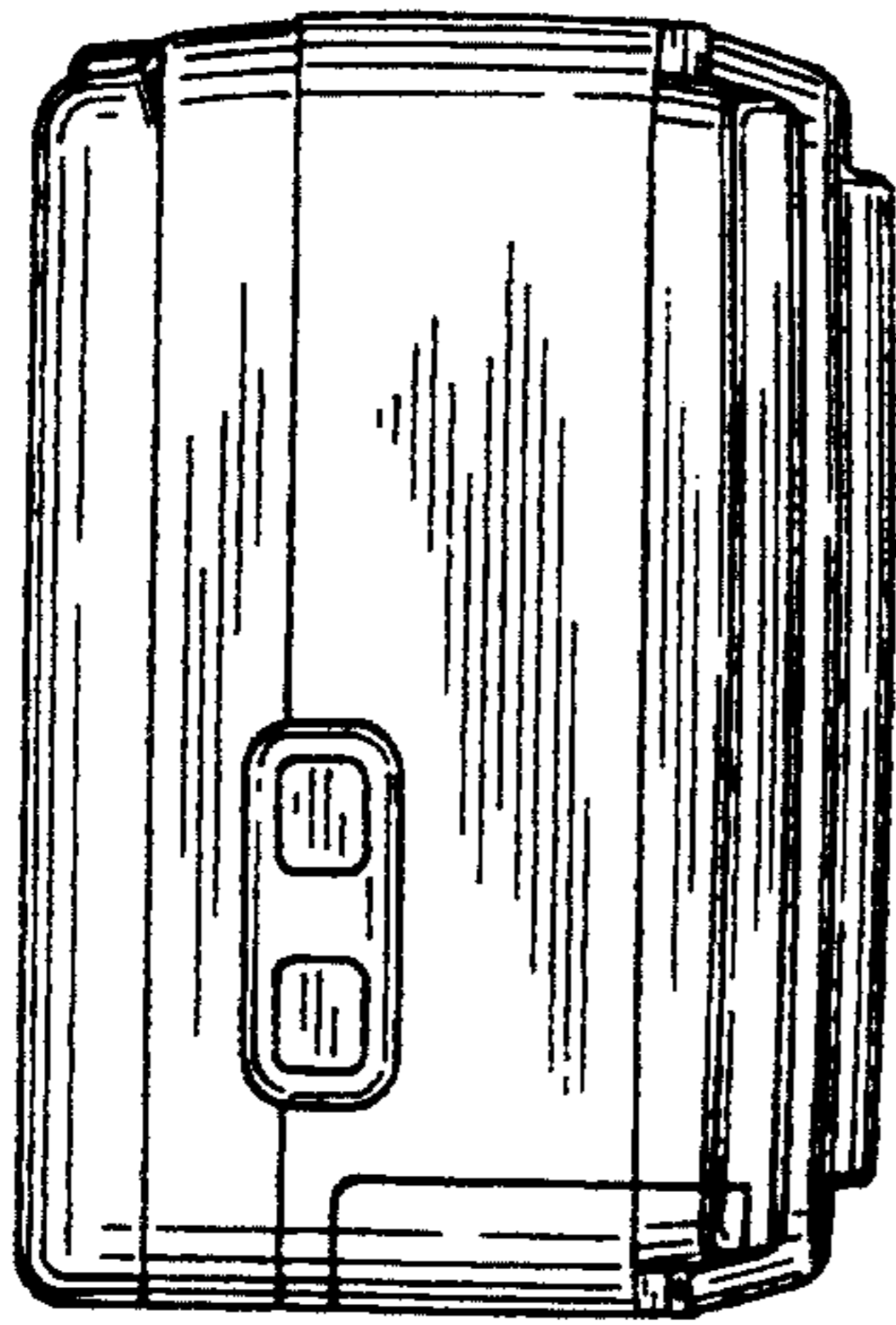

FIG. 12

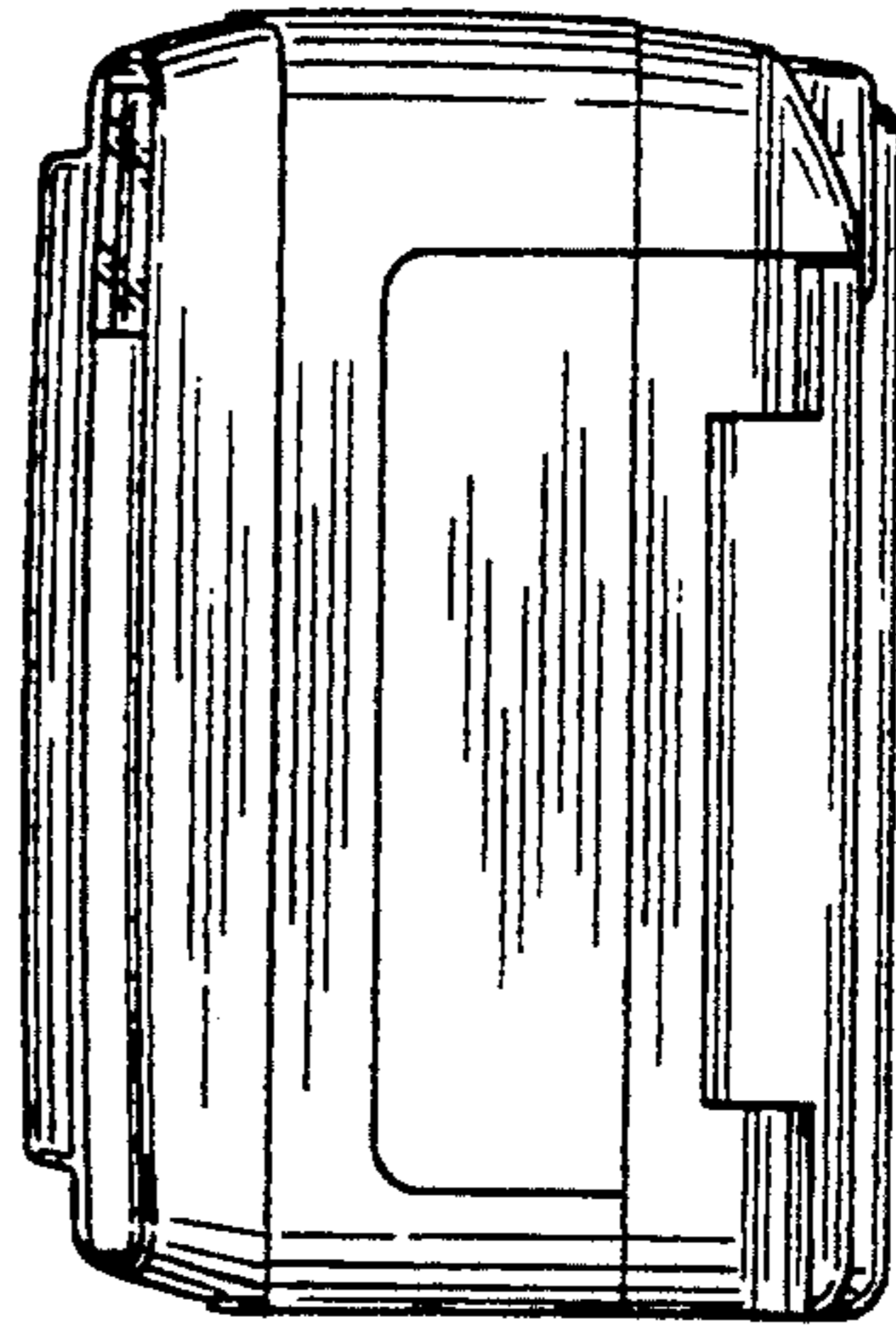

FIG. 13

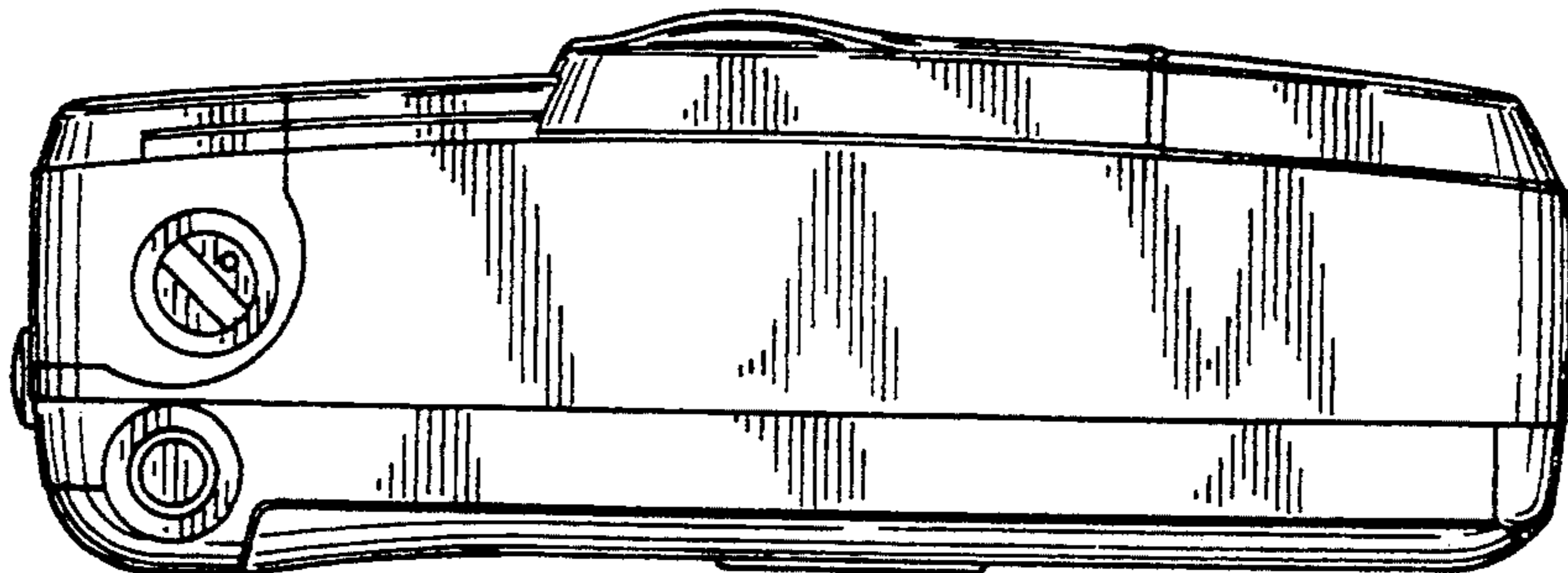

FIG. 14

