



US00D359494S

United States Patent [19]

[11] Patent Number: **Des. 359,494**

Hedaya

[45] Date of Patent: **** Jun. 20, 1995**

[54] **BRIDGE PLATE FOR SPEAKERS**

[75] Inventor: **Ezra Hedaya**, Eatontown, N.J.

[73] Assignee: **Royal Sound Co., Inc.**, Eatontown, N.J.

[**] Term: **14 Years**

[21] Appl. No.: **2,929**

[22] Filed: **Dec. 23, 1993**

[52] U.S. Cl. **D14/224**

[58] Field of Search **D14/221, 224, 215;**
381/150, 153, 188

[56] **References Cited**

U.S. PATENT DOCUMENTS

D. 273,008	3/1984	Ishizaki	D14/215
4,811,406	3/1989	Kawachi	381/188
4,837,839	6/1989	Andrews	381/188

OTHER PUBLICATIONS

Stereo Review; Dec. 1985; p. 38; Car Speaker.
Stereo Review; Aug. 1986; p. 46; Speaker.

Primary Examiner—B. J. Bullock
Attorney, Agent, or Firm—Ezra Sutton

[57] **CLAIM**

The ornamental design for a bridge plate for speaker, as shown and described.

DESCRIPTION

FIG. 1 is a perspective view of a bridge plate for speakers embodying my new design;
FIG. 2 is a top plan view thereof;
FIG. 3 is a bottom plan view thereof;
FIG. 4 is a right side elevation view;
FIG. 5 is a left side elevation view;
FIG. 6 is a right end view;
FIG. 7 is a left end view;
FIG. 8 is a reduced top plan view thereof, the edge of an oval speaker being shown in broken lines for illustrative purposes only and forming no part of the claimed design; and,
FIG. 9 is a reduced top plan view thereof, the edge of a circular speaker again being shown in broken lines for illustrative purposes only.

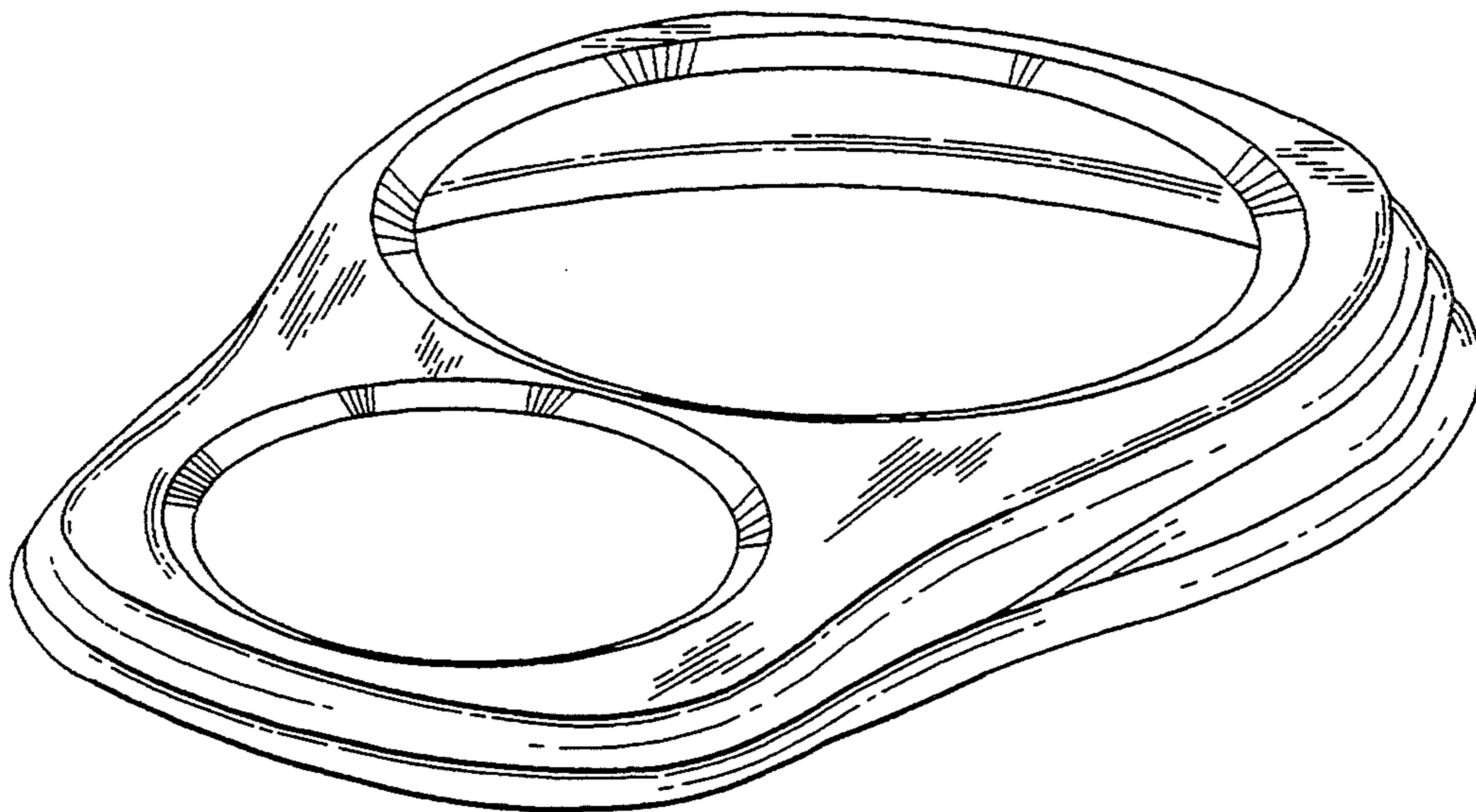

FIG. 1

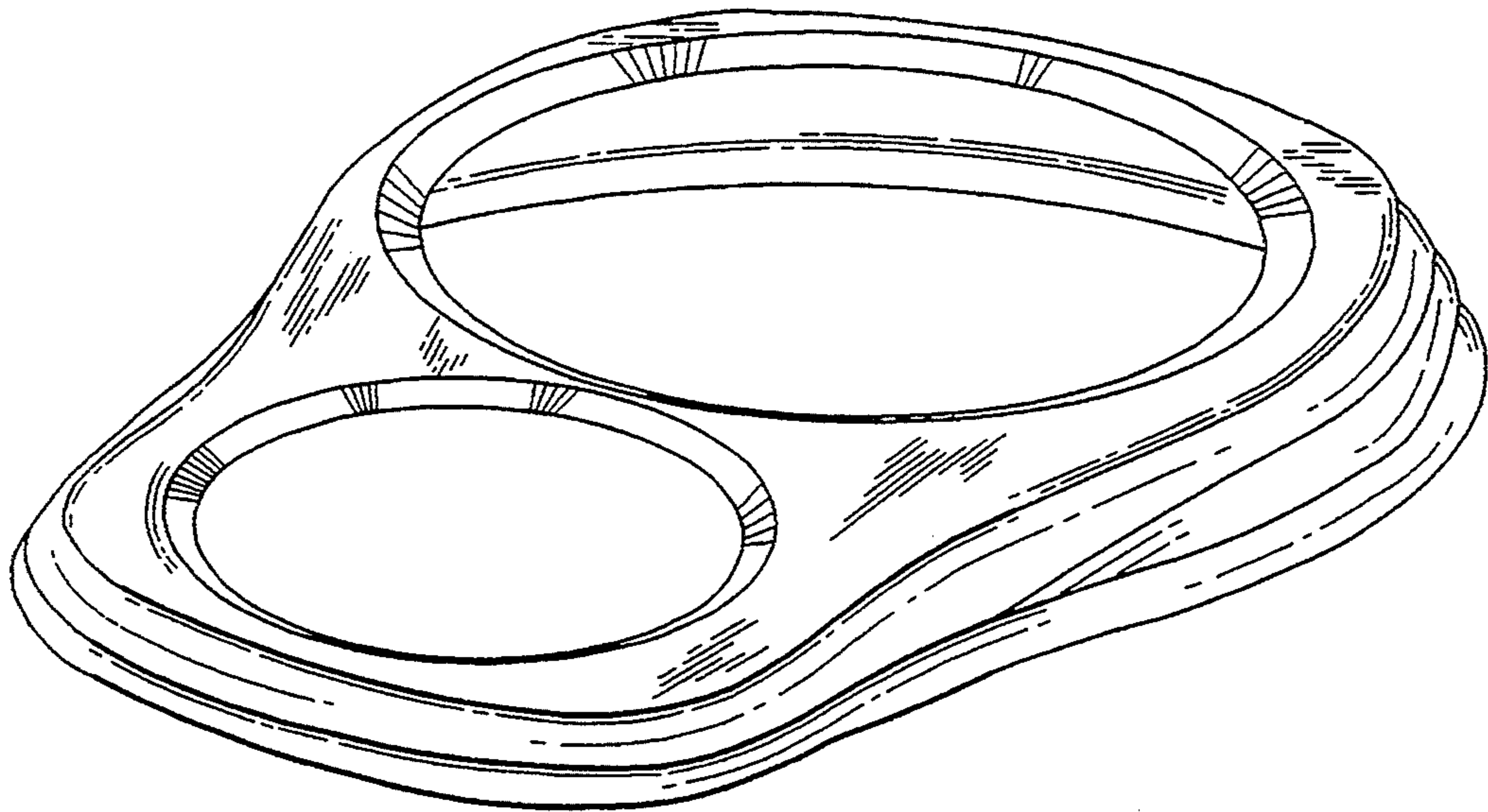

FIG. 2

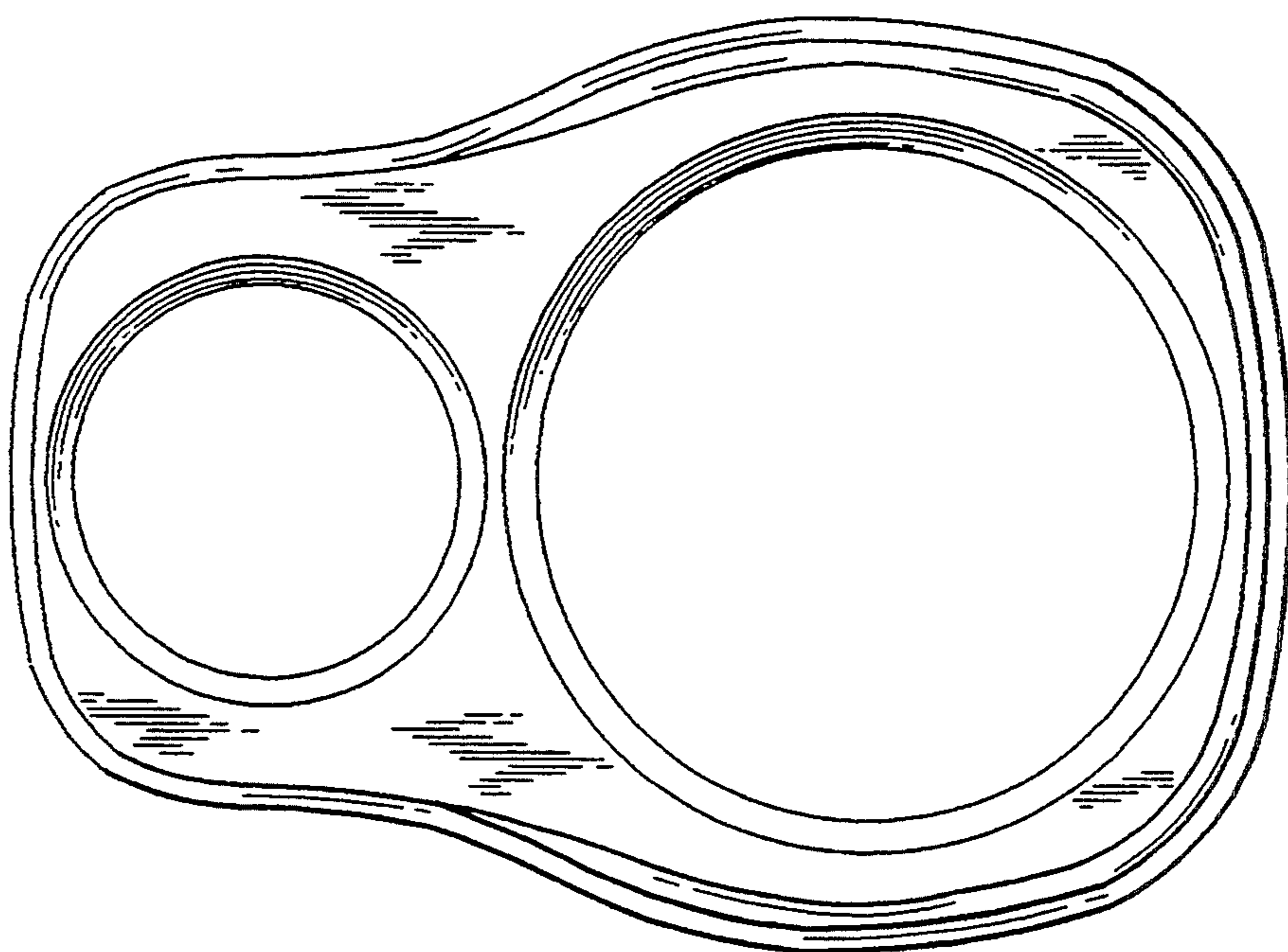

FIG. 3

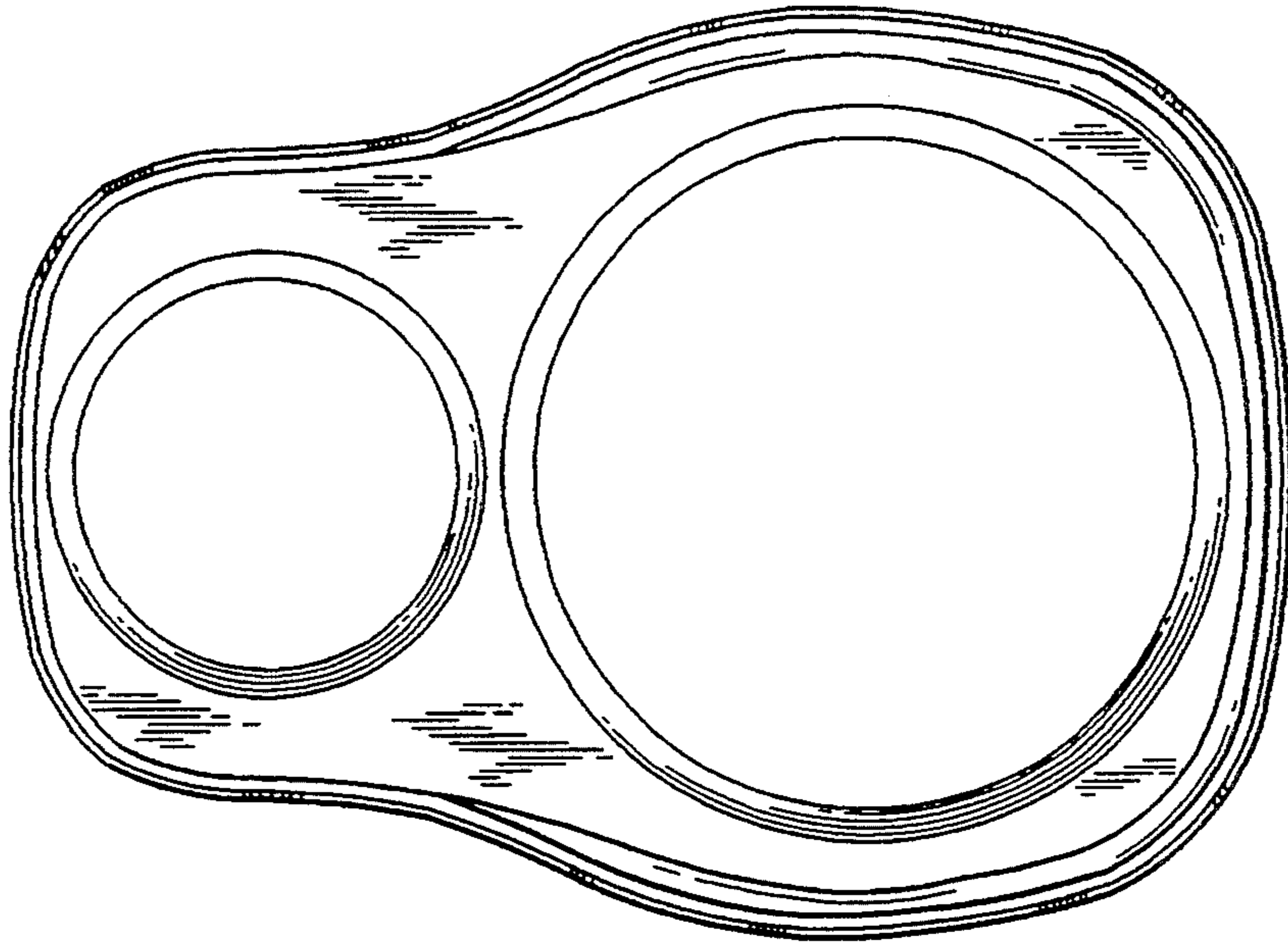

FIG. 4

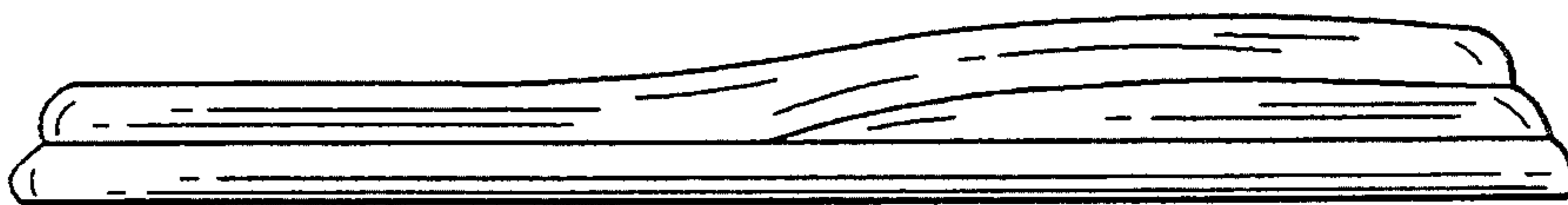

FIG. 5

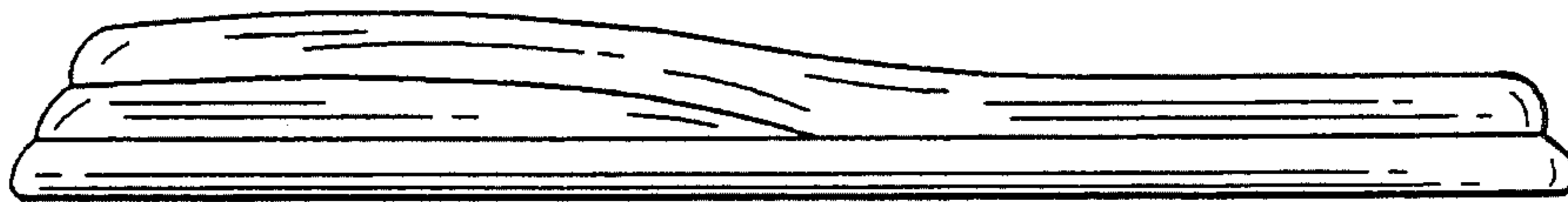

FIG. 6

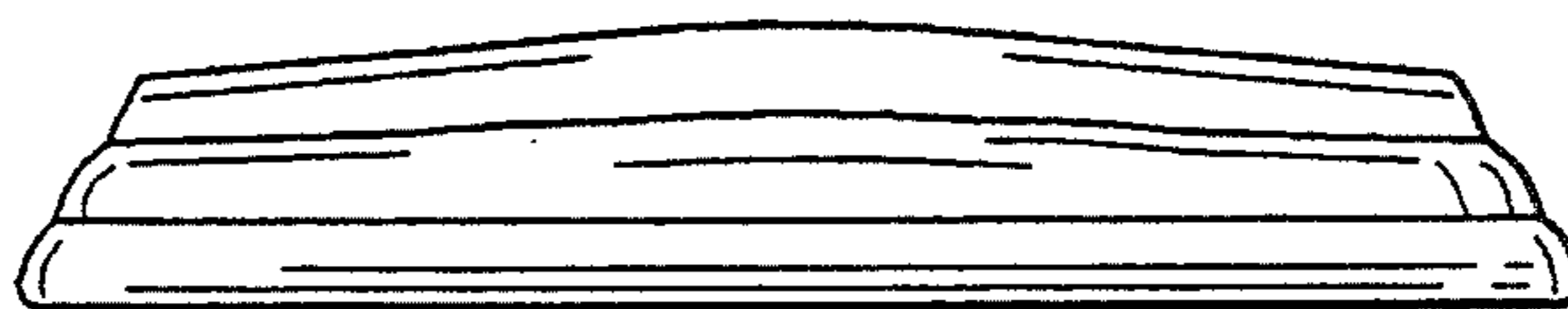

FIG. 7

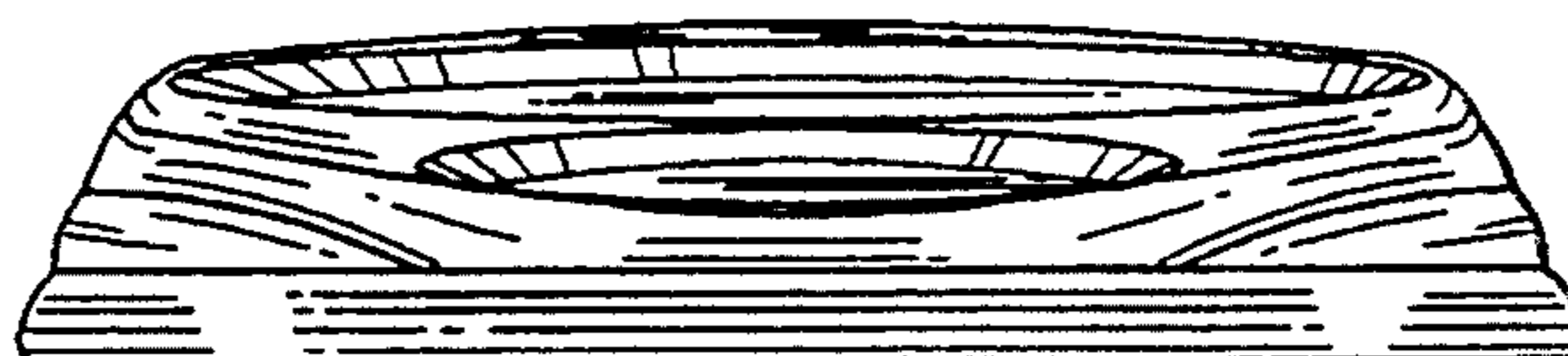

FIG. 8

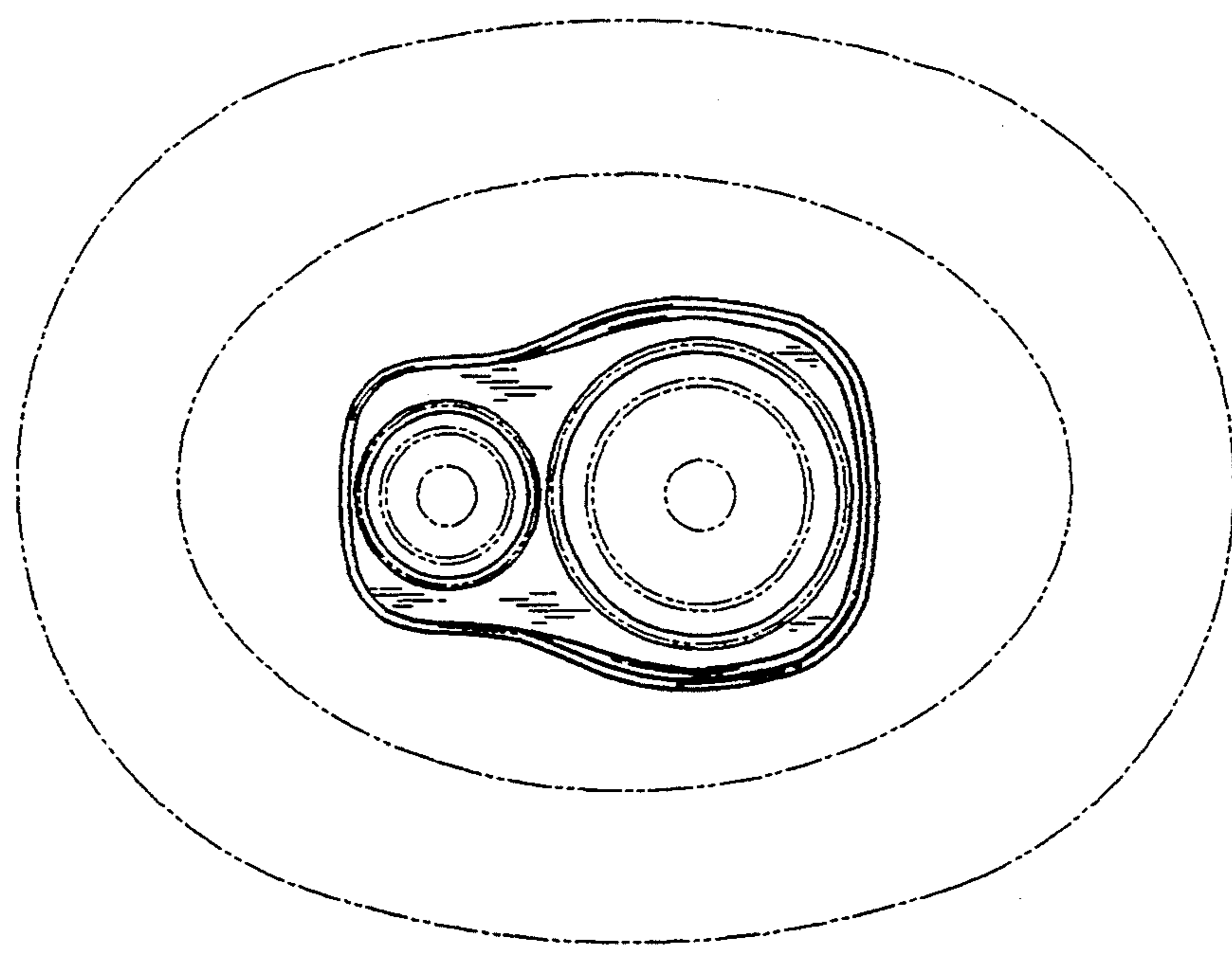

FIG. 9

