



US00D359440S

United States Patent [19]

[11] Patent Number: **Des. 359,440**

Stewart

[45] Date of Patent: **** Jun. 20, 1995**

[54] CORD REEL

[75] Inventor: **Craig Stewart, Noblesville, Ind.**

[73] Assignee: **Woods Industries, Inc., Carmel, Ind.**

[**] Term: **14 Years**

[21] Appl. No.: **9,608**

[22] Filed: **Jun. 16, 1993**

[52] U.S. Cl. **D8/359; D8/358**

[58] Field of Search **D8/358-359; 242/77, 77.1, 83, 86, 96, 118.7-118.8, 77.3**

D. 301,834	6/1989	Soltes	D8/358
D. 314,910	2/1991	VanSkiver	D8/359
D. 341,770	11/1993	Spear et al.	D8/359
3,104,076	9/1963	Wilson .	
3,494,570	2/1970	Jones, Jr. .	
3,731,887	5/1973	Wheeler .	
3,983,977	10/1976	Crabb .	
4,143,746	3/1979	Lowery .	
4,244,536	1/1981	Harrill .	
4,330,005	5/1982	Kjarsgaard	D8/358 X
4,330,905	5/1982	Kjarsgaard .	
4,467,979	8/1984	Koehler .	
4,557,430	12/1985	Bonhard .	

[56] **References Cited**

U.S. PATENT DOCUMENTS

D. 79,201	6/1928	Mills .	
D. 90,523	6/1933	Boesel .	
D. 179,980	4/1957	Peras .	
D. 196,128	8/1963	Wilson	D8/359
D. 200,791	4/1965	Smith .	
D. 202,366	9/1965	Bishop	D8/358
D. 203,622	2/1966	Quenot .	
D. 205,373	7/1966	Quenot .	
D. 215,646	10/1969	Anderson .	
D. 224,615	8/1972	Kloefkorn	D8/359
D. 226,898	5/1973	Tamarin	D8/358
D. 230,705	3/1974	Lilland et al. .	
D. 247,442	3/1978	Hiraishi et al. .	
D. 252,792	9/1979	Hobbs .	
D. 260,029	7/1981	Gehrke .	
D. 263,371	3/1982	Allen	D8/358
D. 268,734	4/1983	Soltes	D8/358
D. 281,574	12/1985	O'Hara, II	D8/358
D. 281,763	12/1985	Smith	D8/359

OTHER PUBLICATIONS

Hardware Age, Aug. 1986, p. 133, reels located at upper right hand corner of page.

Primary Examiner—Susan J. Lucas
Assistant Examiner—H. Baynham
Attorney, Agent, or Firm—McAndrews, Held & Malloy, Ltd.

[57] **CLAIM**

The ornamental design for the cord reel, as shown and described.

DESCRIPTION

FIG. 1 is a perspective view of a cord reel;
FIG. 2 is a left side view of the cord reel of FIG. 1;
FIG. 3 is a front view of the cord reel of FIG. 1;
FIG. 4 is a right side view of cord reel of FIG. 1;
FIG. 5 is a rear view of the cord reel of FIG. 1;
FIG. 6 is a top view of the cord reel of FIG. 1; and,
FIG. 7 is a bottom view of the cord reel of FIG. 1.

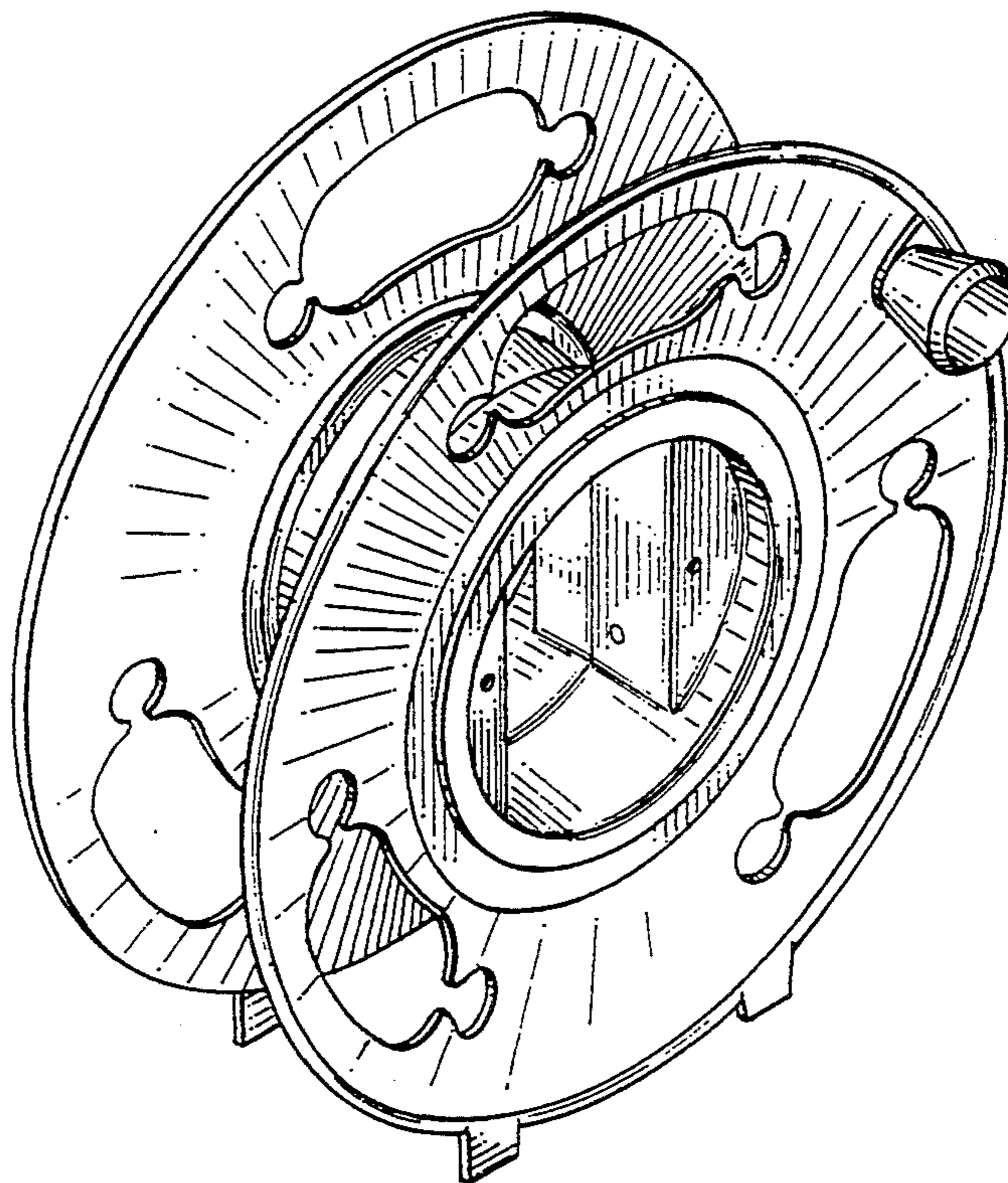

Fig. 1

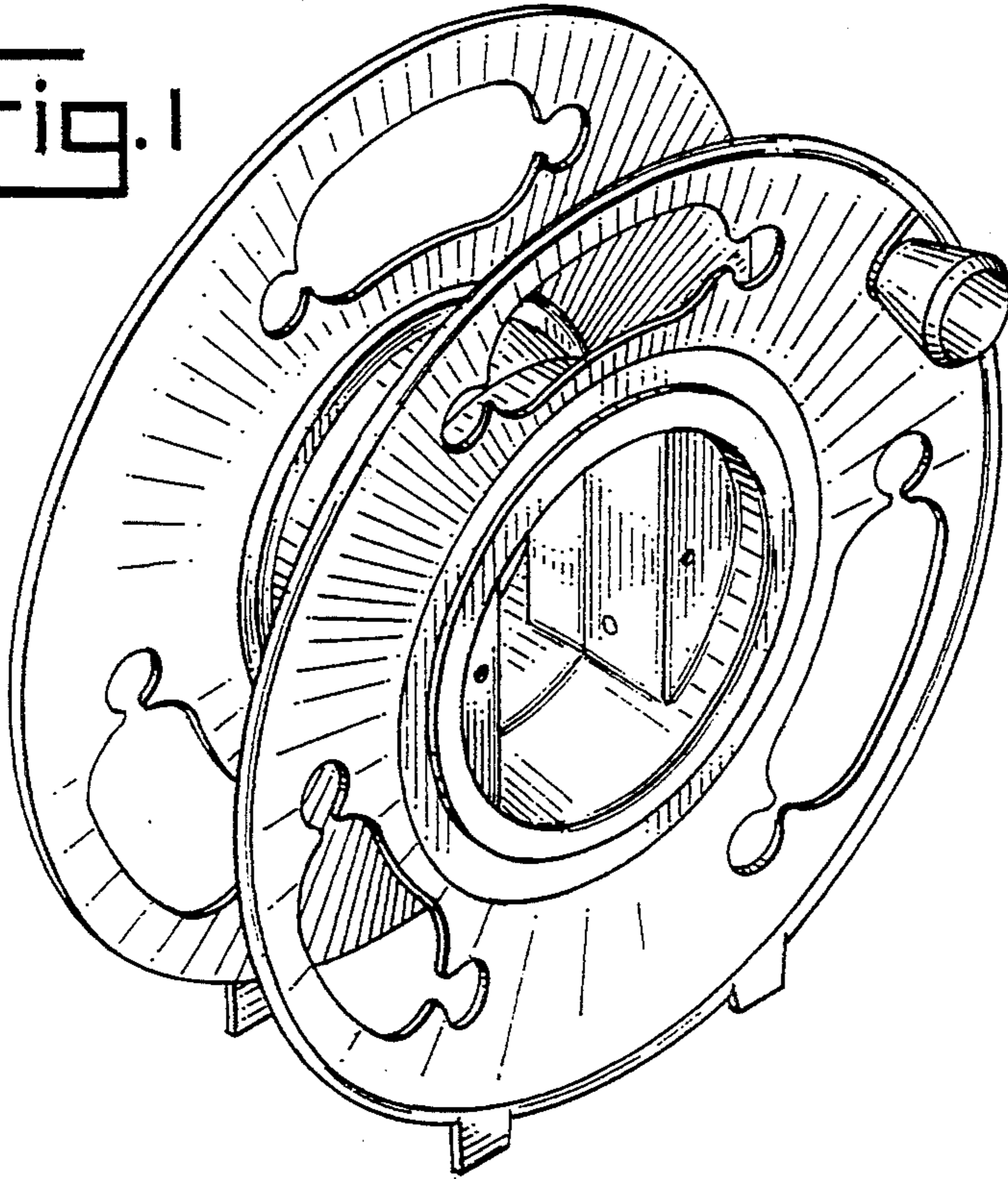

Fig. 2

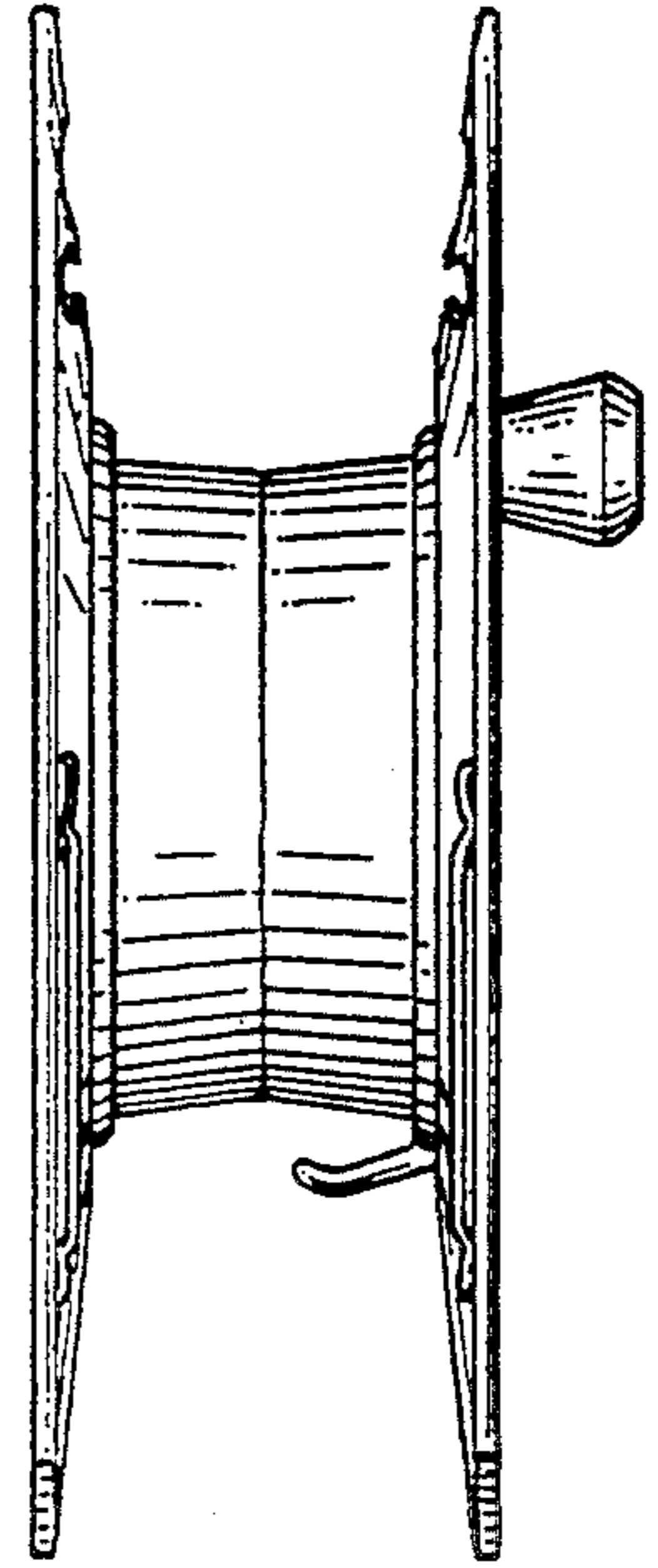

Fig. 3

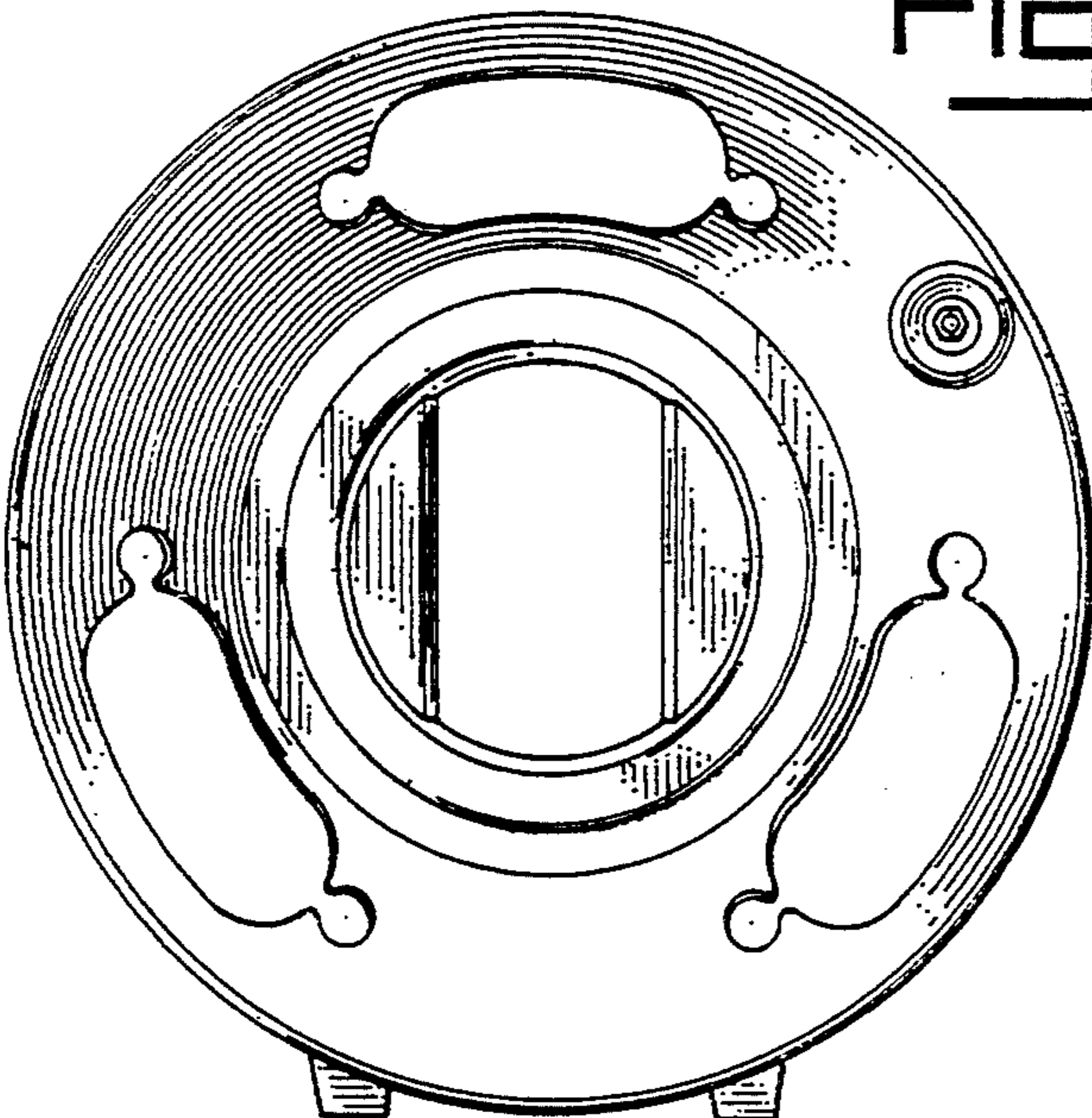

Fig. 4

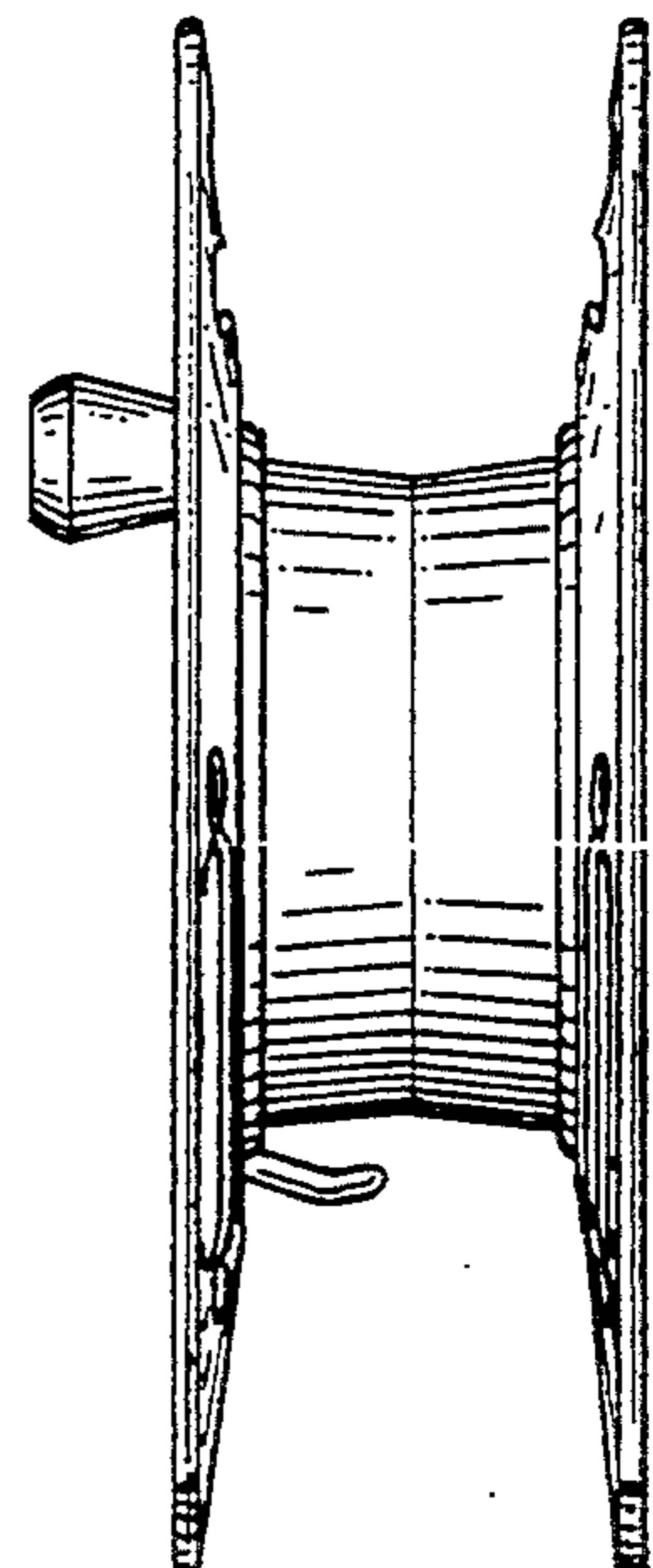

Fig. 5

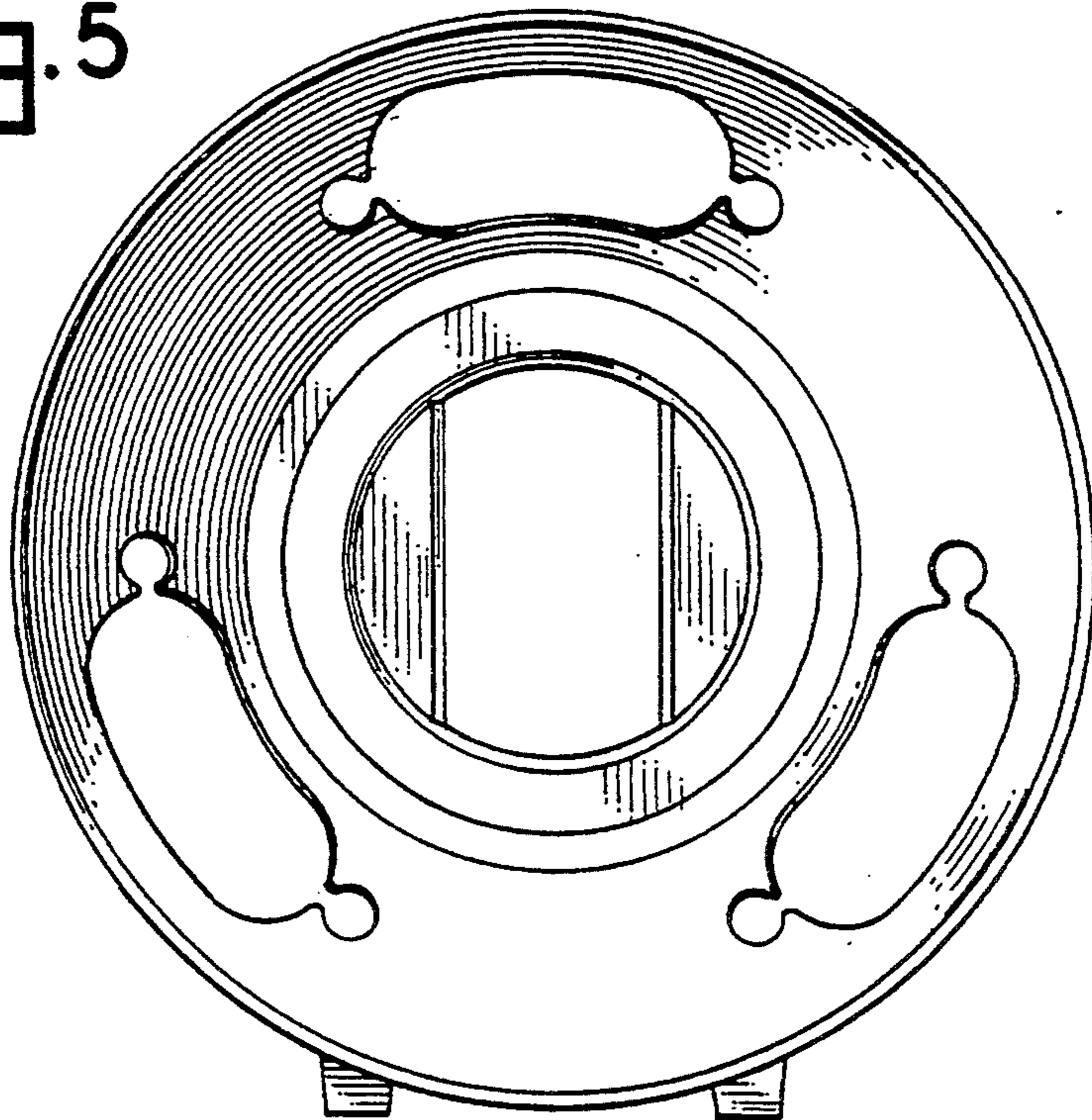

Fig. 6

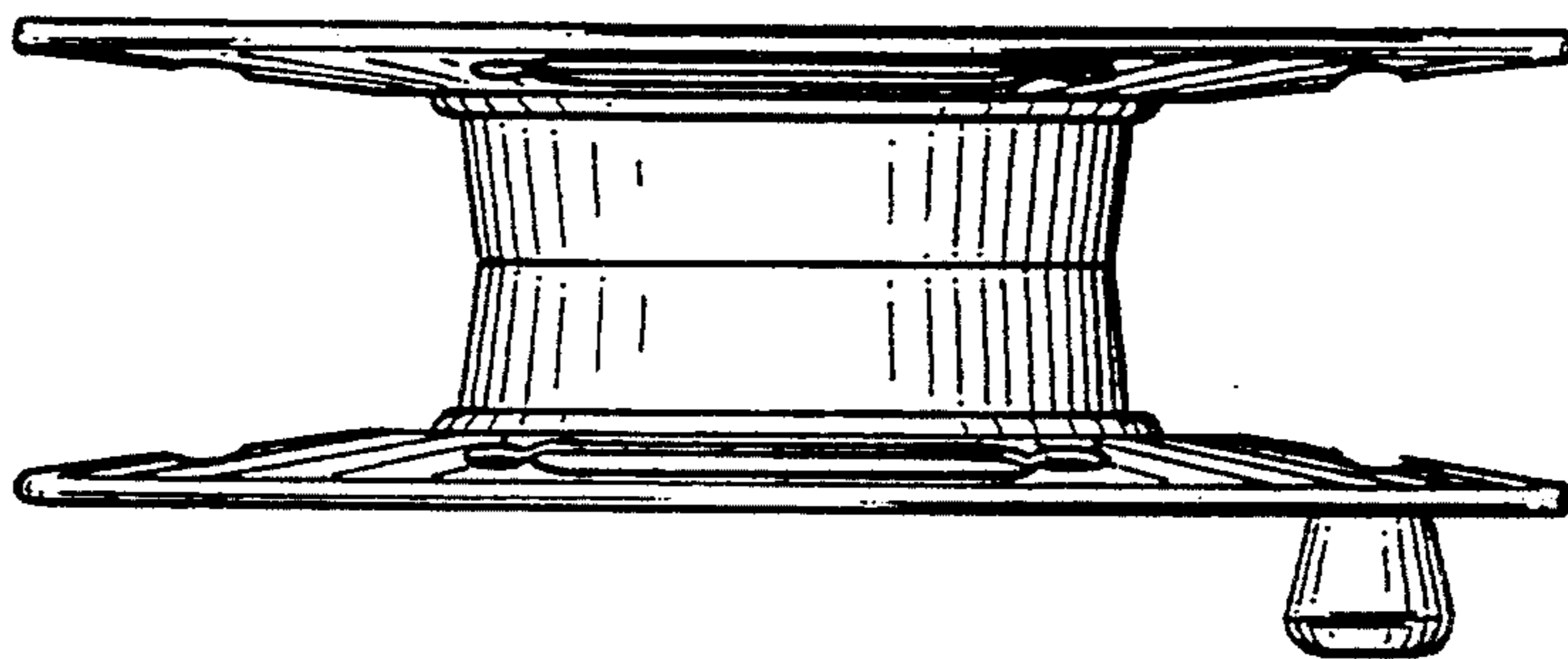

Fig. 7

