



US00D359415S

United States Patent [19]

[11] Patent Number: **Des. 359,415**

van Berlo

[45] Date of Patent: **** Jun. 20, 1995**

[54] **OVEN**

[75] Inventor: **Adrianus A. J. van Berlo**, Eindhoven, Netherlands

[73] Assignee: **Fri-Jado B.V.**, Netherlands

[**] Term: **14 Years**

[21] Appl. No.: **817,427**

[22] Filed: **Jan. 2, 1992**

[30] **Foreign Application Priority Data**
 Dec. 17, 1991 [XH] Hague Agreement DM/021456

[52] U.S. Cl. **D7/351**

[58] Field of Search D7/338, 347-351; 99/419, 474, 341; 126/273 R, 275 R, 275 E; 219/391, 393, 400

D. 303,062 8/1989 Takada et al. D7/350
 D. 304,281 10/1989 Naito et al. D7/351
 D. 305,596 1/1990 Nishibon D7/351
 D. 329,569 9/1992 Ichihara et al. D7/351
 4,781,109 11/1988 Wiebe, Jr. et al. 99/419
 5,160,829 11/1992 Chang 219/400

Primary Examiner—Ruth McInroy
Attorney, Agent, or Firm—Ostrolenk, Faber, Gerb & Soffen

[57] CLAIM

The ornamental design for a oven, as shown and described.

DESCRIPTION

FIG. 1 is a top, front and side perspective view of an oven showing my new design;
 FIG. 2 is a rear perspective view thereof;
 FIG. 3 is a left side elevational view thereof;
 FIG. 4 is a front elevational view thereof;
 FIG. 5 is a right side elevational view thereof;
 FIG. 6 is a rear elevational view thereof;
 FIG. 7 is a top plan view thereof; and,
 FIG. 8 is a bottom plan view thereof.

[56] **References Cited**

U.S. PATENT DOCUMENTS

D. 191,602 10/1961 Crease D7/350
 D. 276,122 10/1984 Tanaka et al. D7/351
 D. 280,968 10/1985 Song D7/351
 D. 290,082 6/1987 Song D7/351

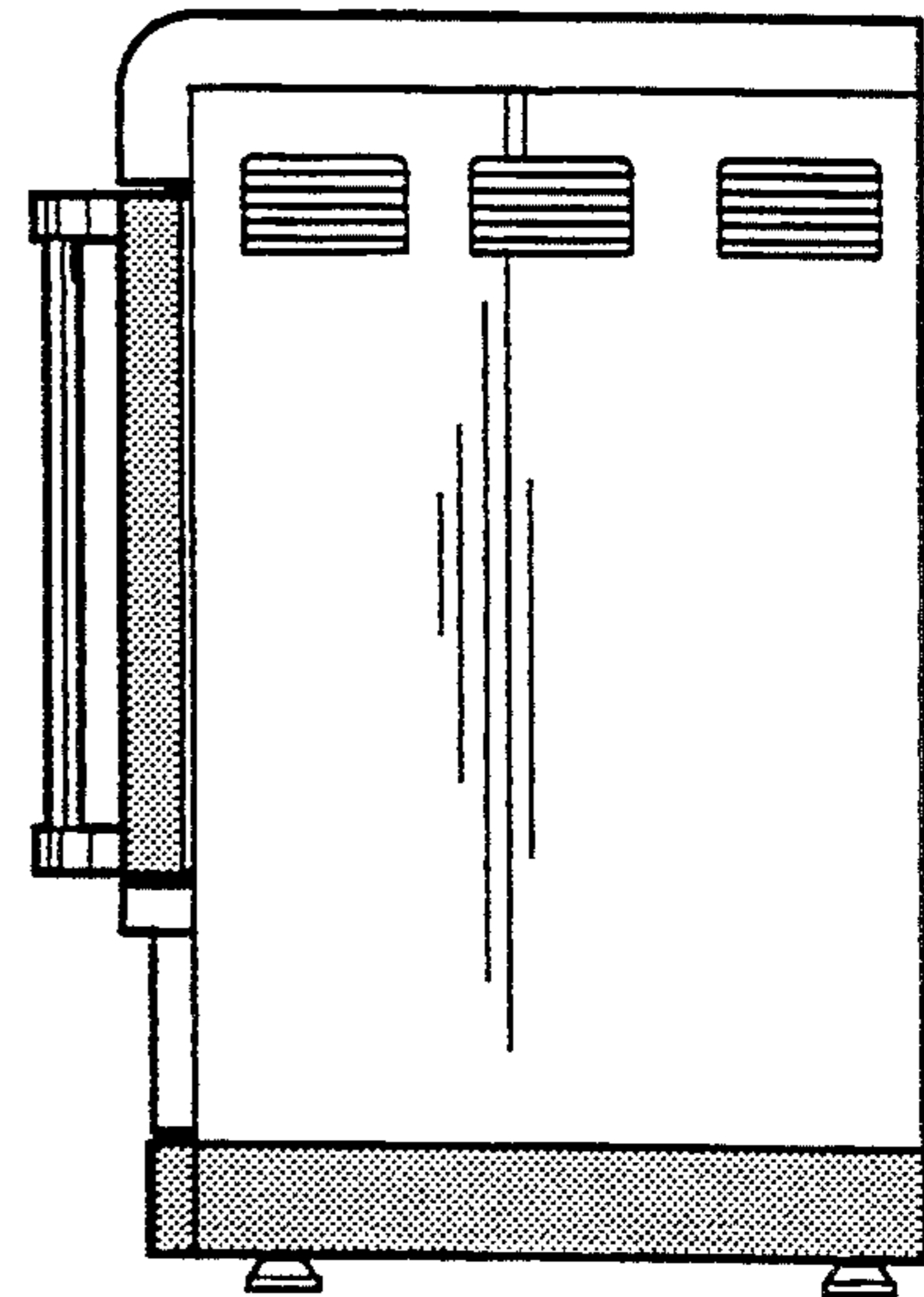
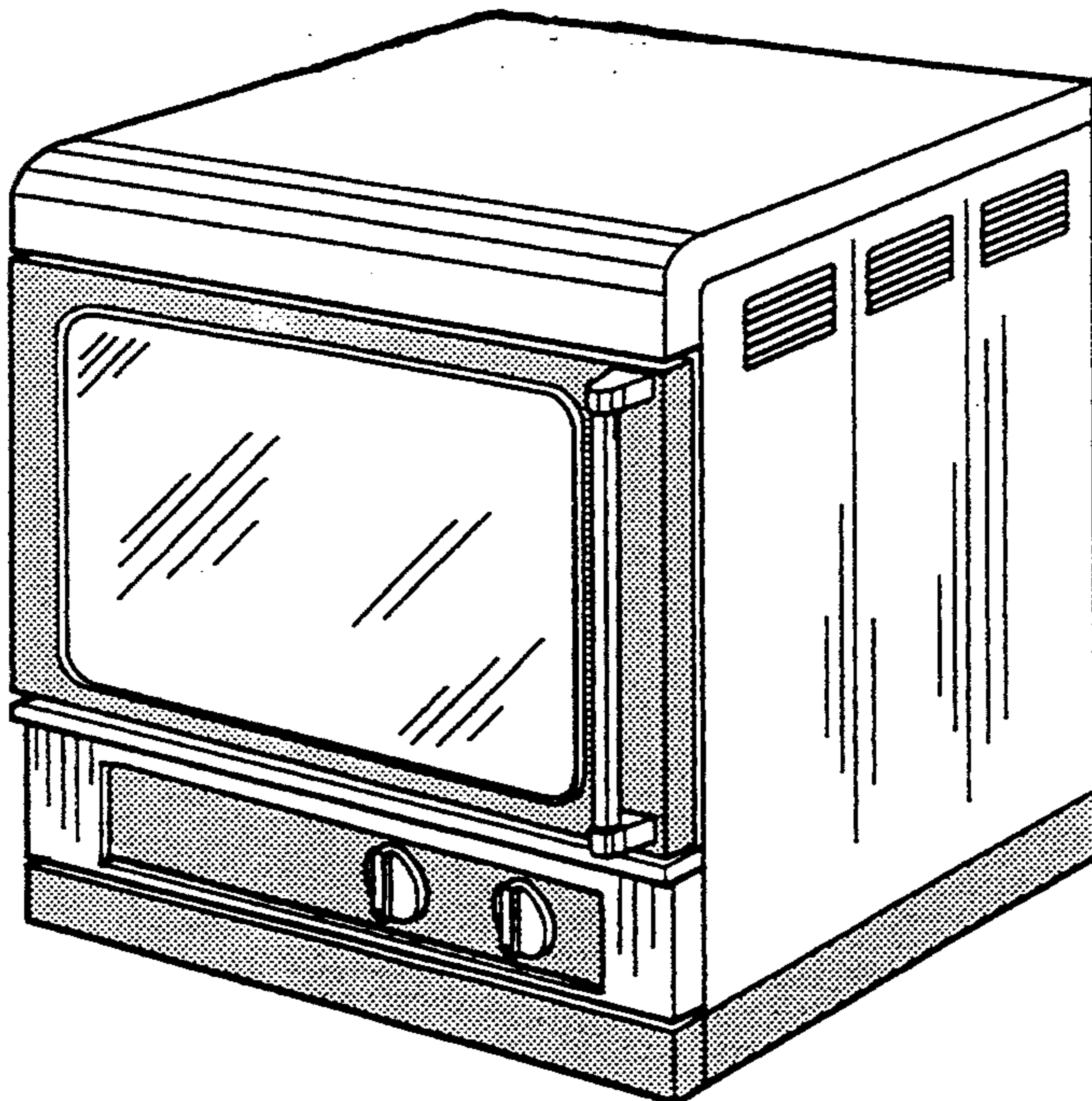

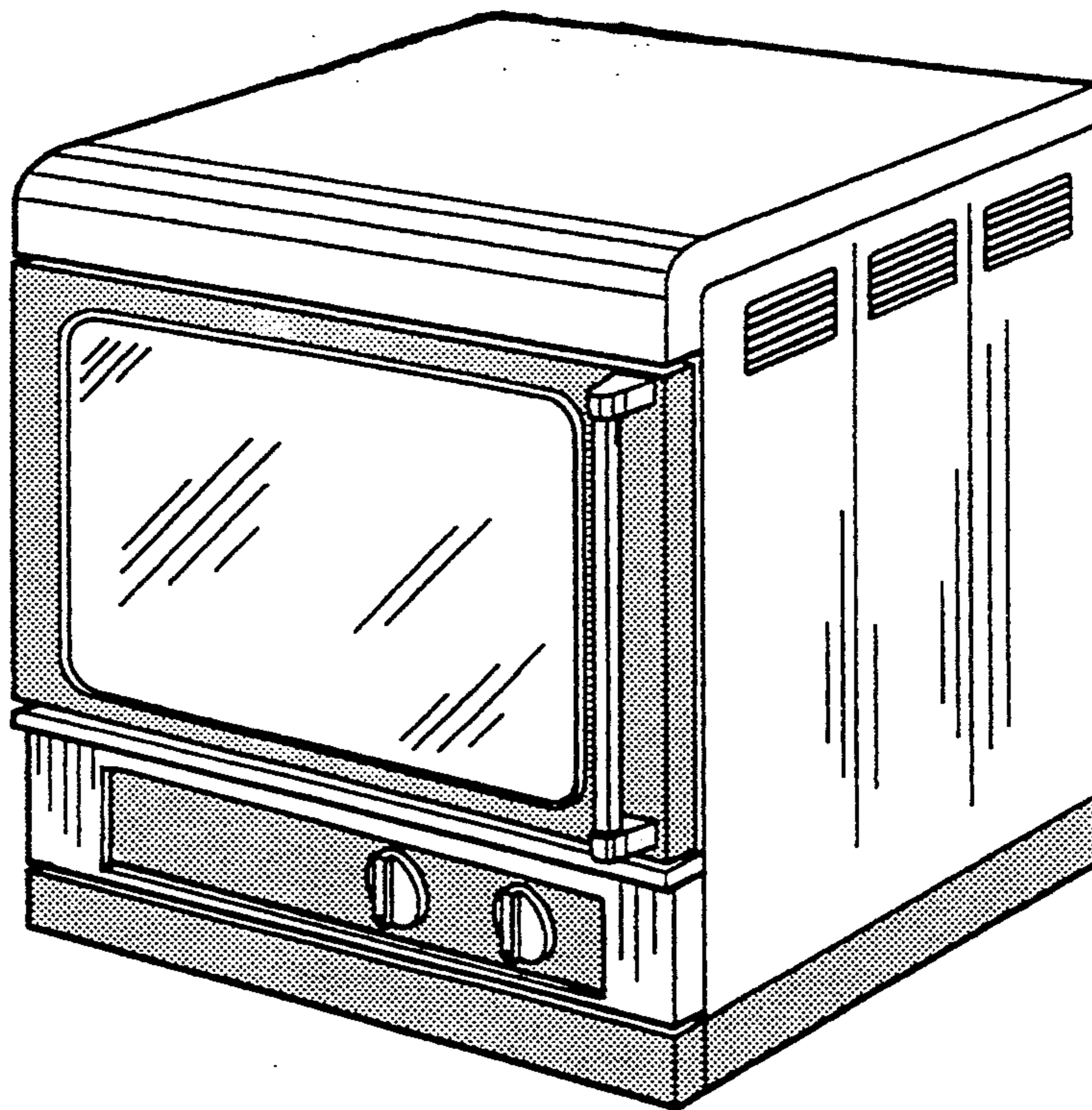

FIG. 1.

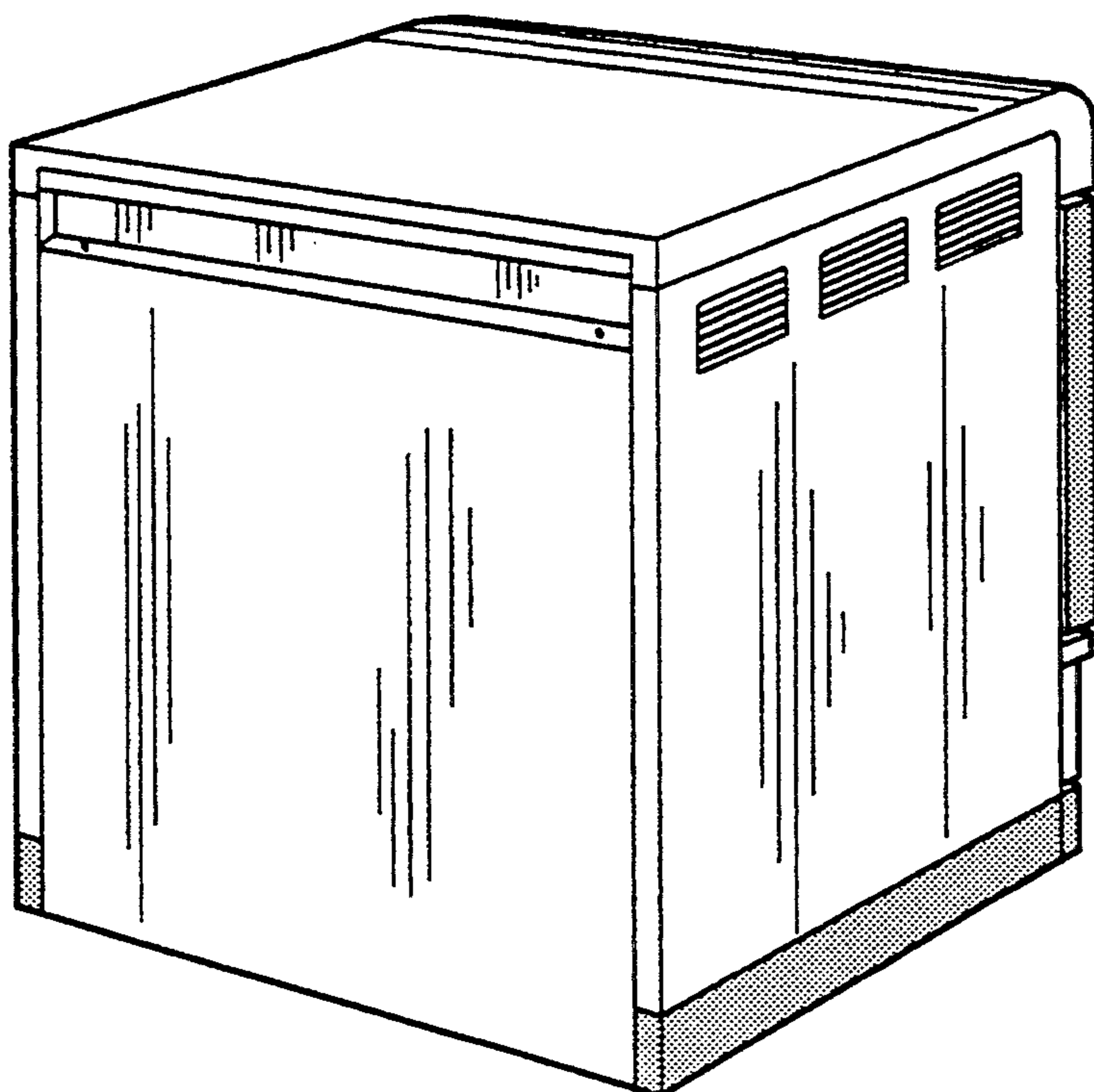

FIG. 2.

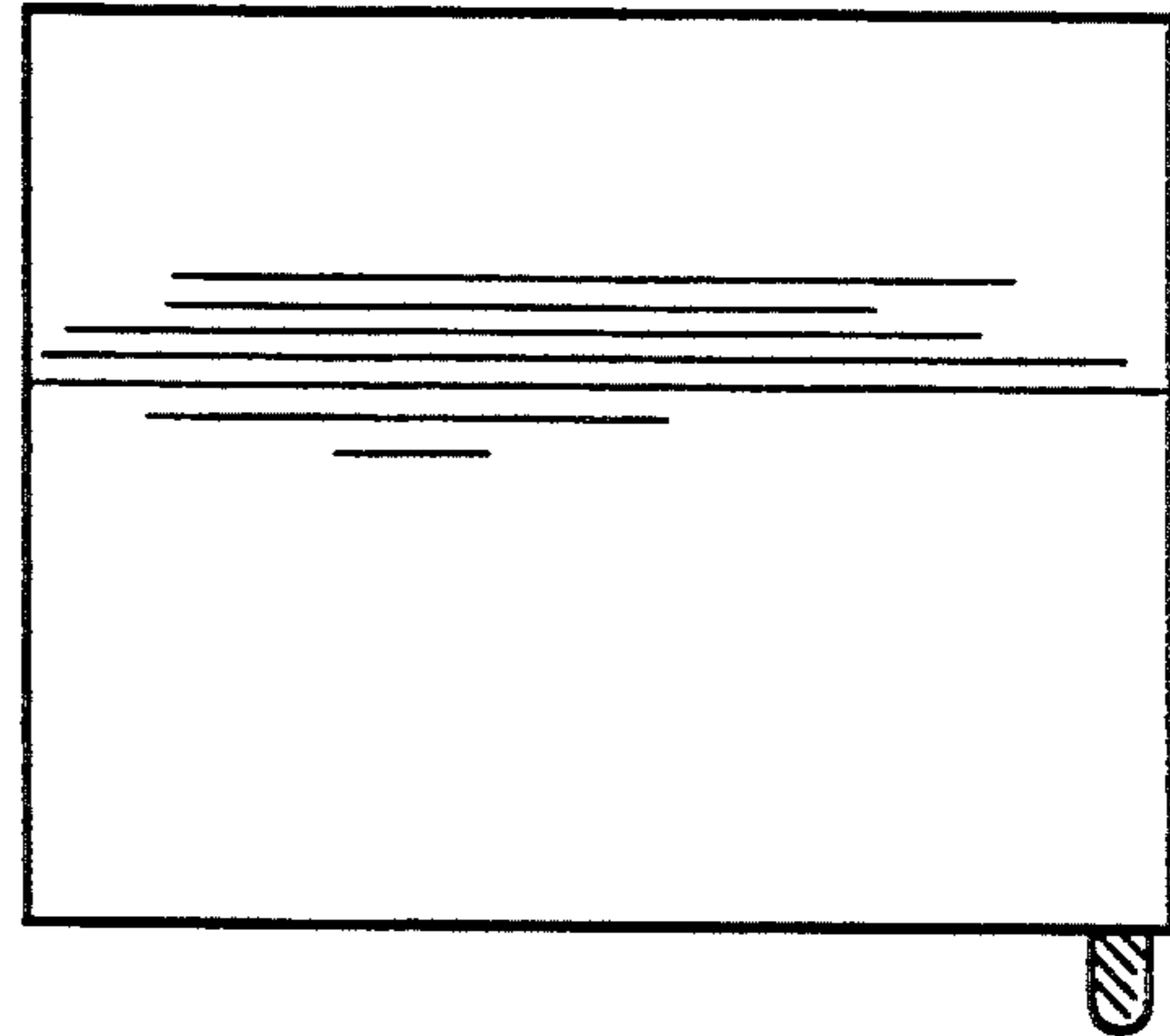

FIG. 7.

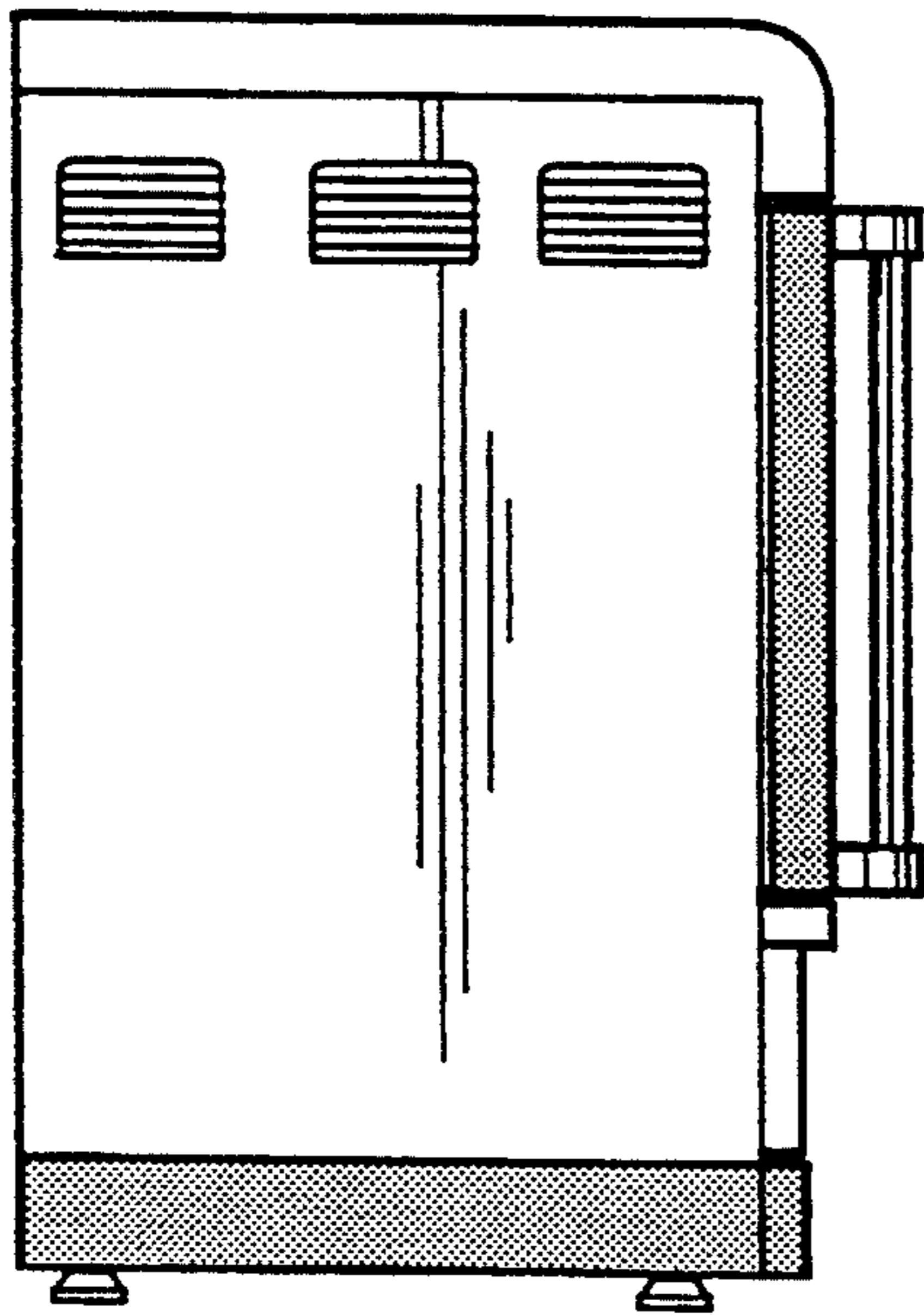

FIG. 5.

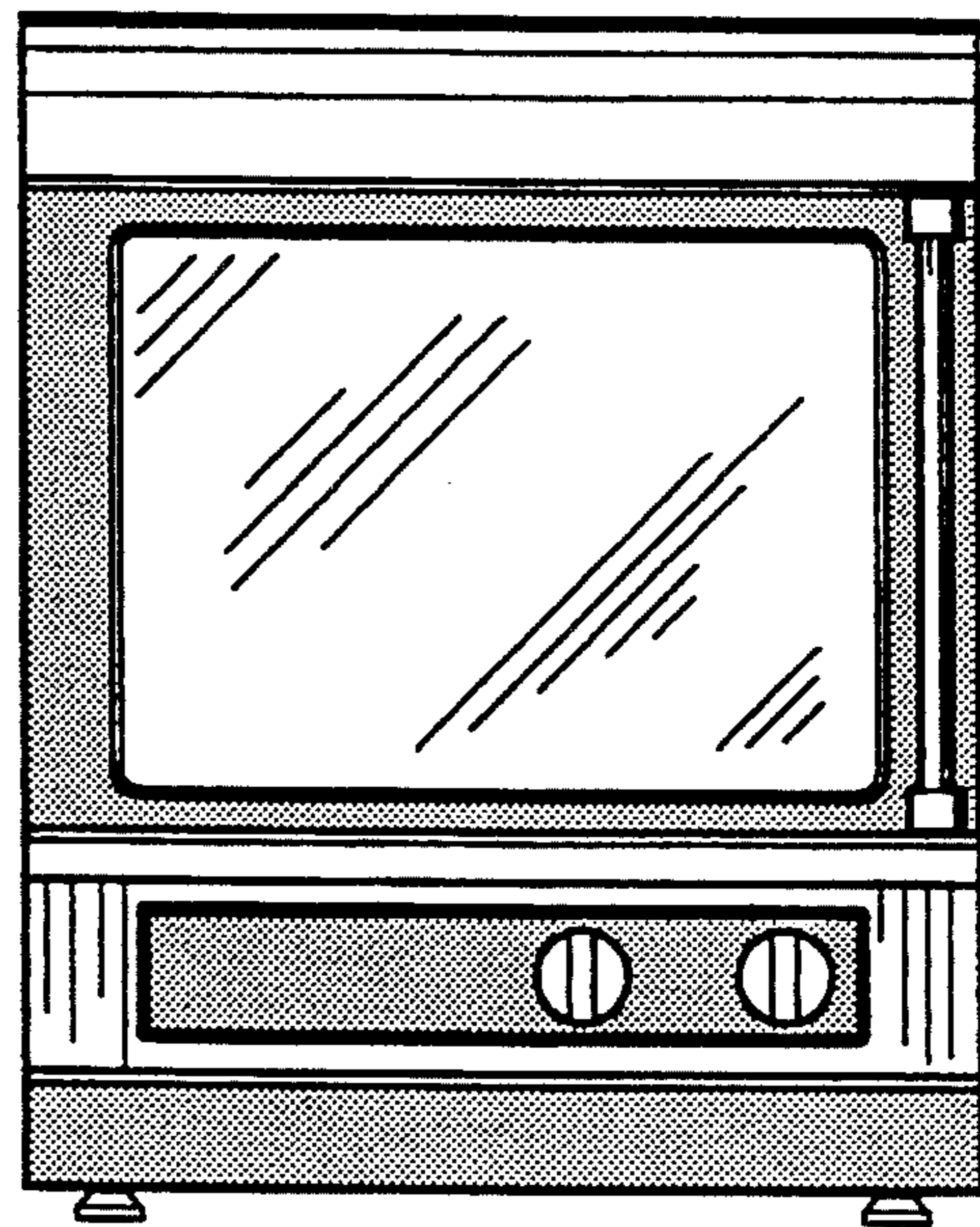

FIG. 4.

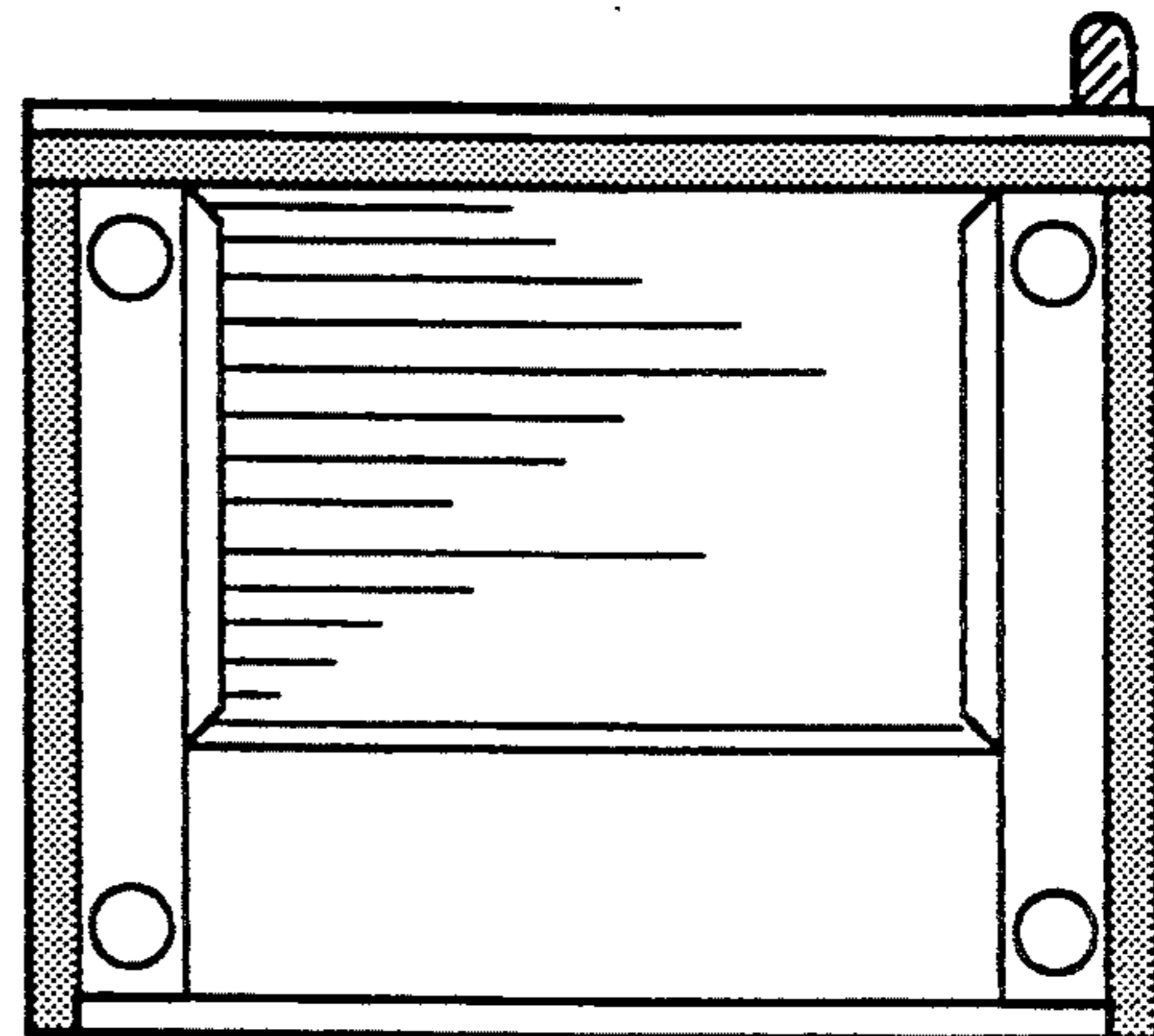

FIG. 6.

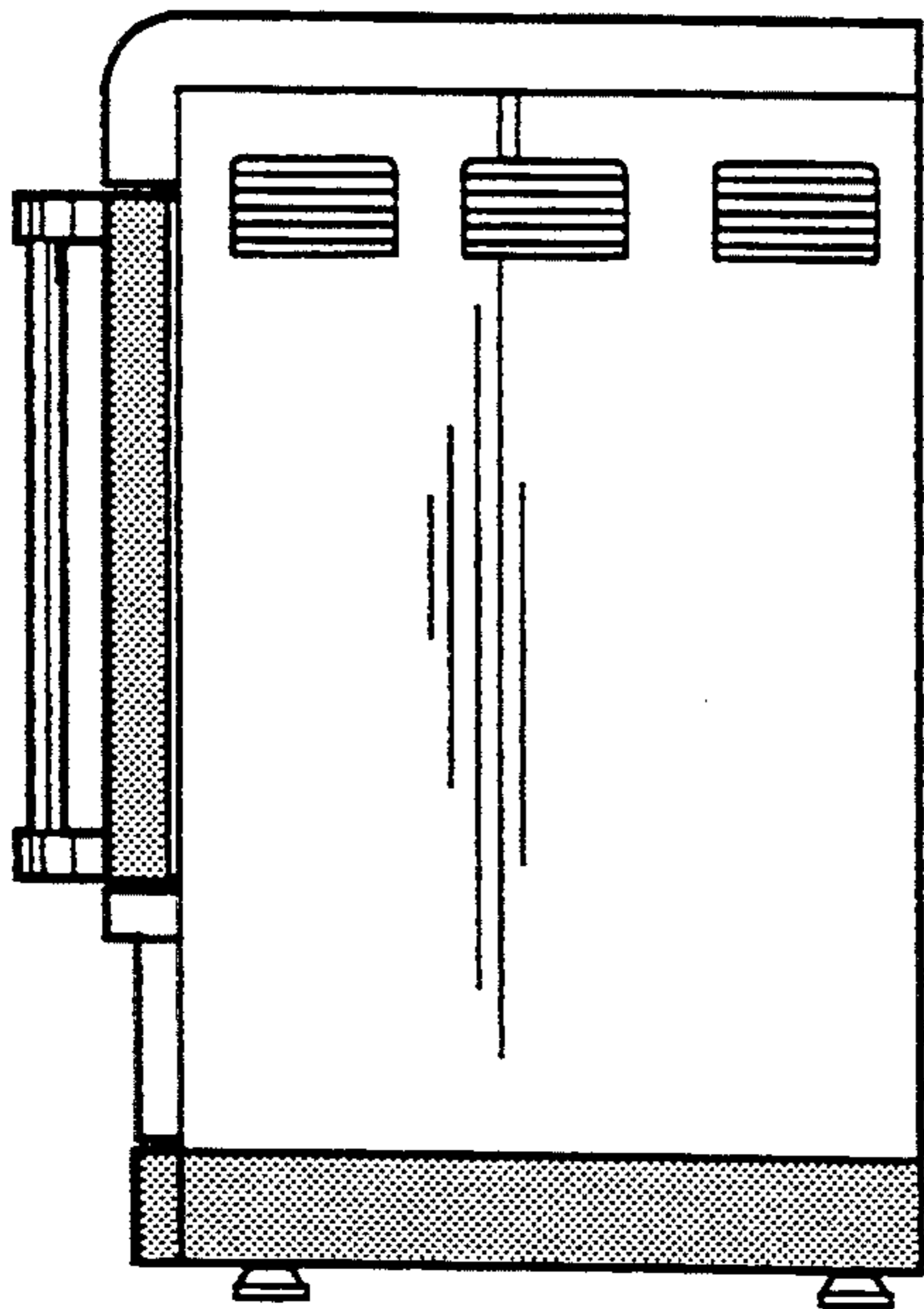

FIG. 5.

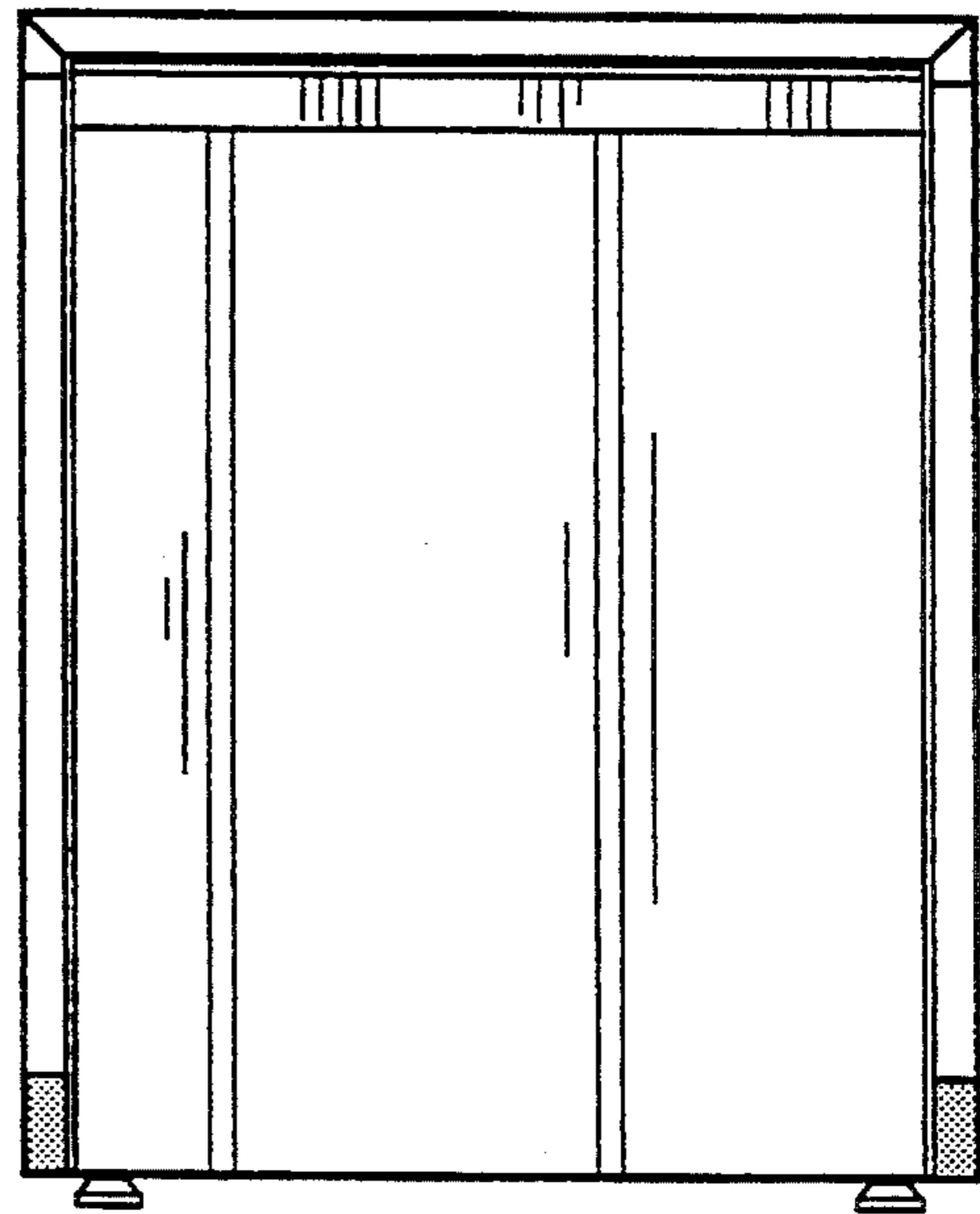

FIG. 6.