



US00D359412S

**United States Patent** [19]  
**Minh**

[11] **Patent Number: Des. 359,412**

[45] **Date of Patent: \*\* Jun. 20, 1995**

[54] **DISPENSER COOLER**

[75] **Inventor: Tran Q. Minh, Stockbridge, Ga.**

[73] **Assignee: The Coca-Cola Company, Atlanta, Ga.**

[\*\*] **Term: 14 Years**

[21] **Appl. No.: 18,219**

[22] **Filed: Feb. 1, 1994**

[52] **U.S. Cl. .... D7/307; D7/308**

[58] **Field of Search ..... D7/300, 305, 306, 307, D7/308, 309, 310, 311, 312, 398, 397; 222/129.1-129.4**

[56] **References Cited**

**U.S. PATENT DOCUMENTS**

- D. 117,907 12/1939 Martin ..... D7/307
- D. 160,784 11/1953 Huffman ..... D7/307 X
- D. 194,420 1/1963 Cornelius ..... D7/308
- D. 194,527 2/1963 Cornelius ..... D7/308
- D. 195,811 8/1963 Hodgman ..... D7/308
- D. 200,996 5/1965 Cornelius ..... D7/397
- D. 202,688 11/1965 Cornelius ..... D7/398 X

- D. 209,456 1/1968 Cornelius et al. .... D7/308
- D. 218,083 7/1970 Hartley ..... D7/308
- D. 230,902 3/1974 Fogel ..... D7/308
- D. 259,725 6/1981 Wasserstrom et al. .... D7/308

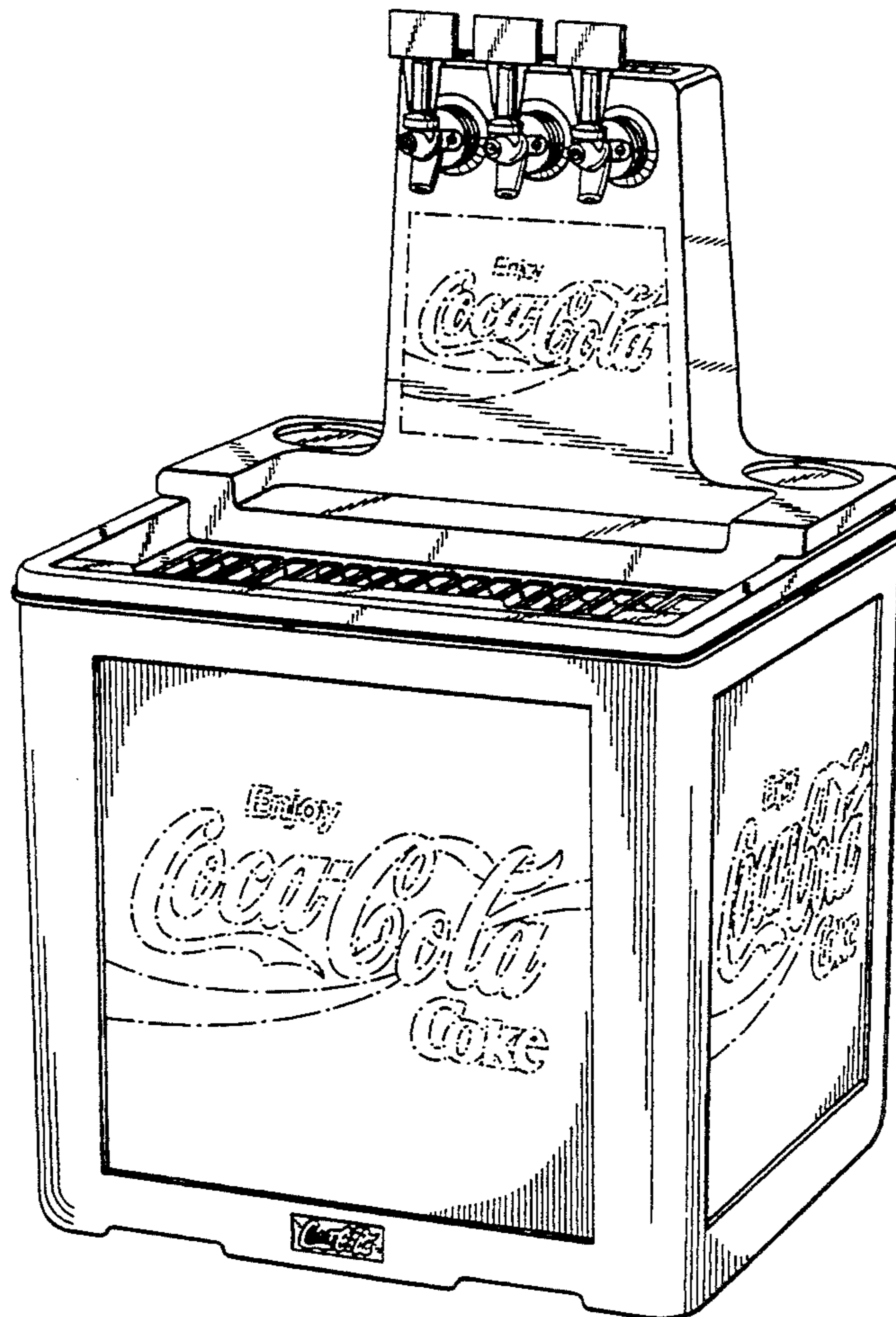
*Primary Examiner*—Alan P. Douglas  
*Assistant Examiner*—M. N. Pandozzi  
*Attorney, Agent, or Firm*—Lynne R. O'Brien

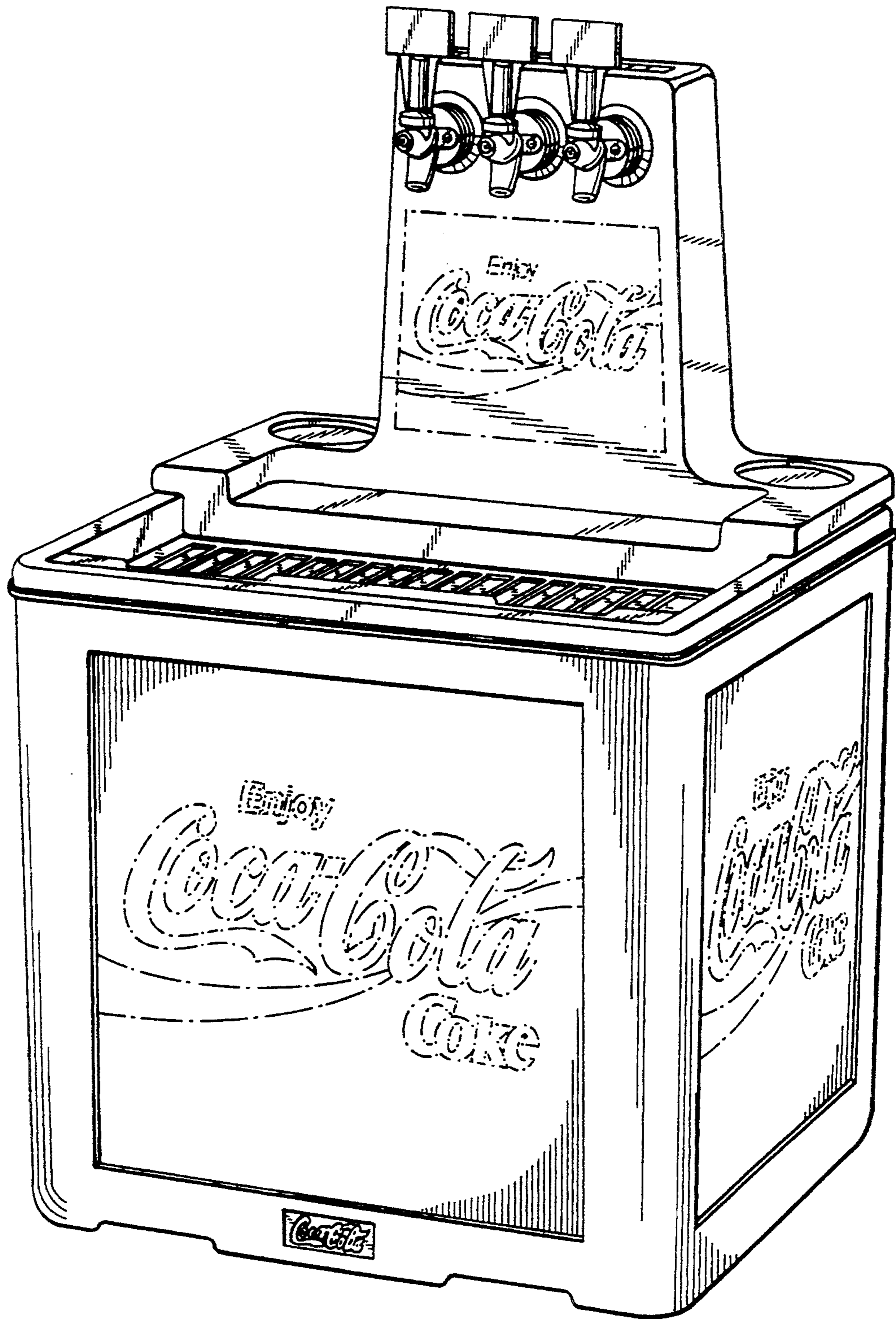
[57] **CLAIM**

The ornamental design for a dispenser cooler, as shown and described.

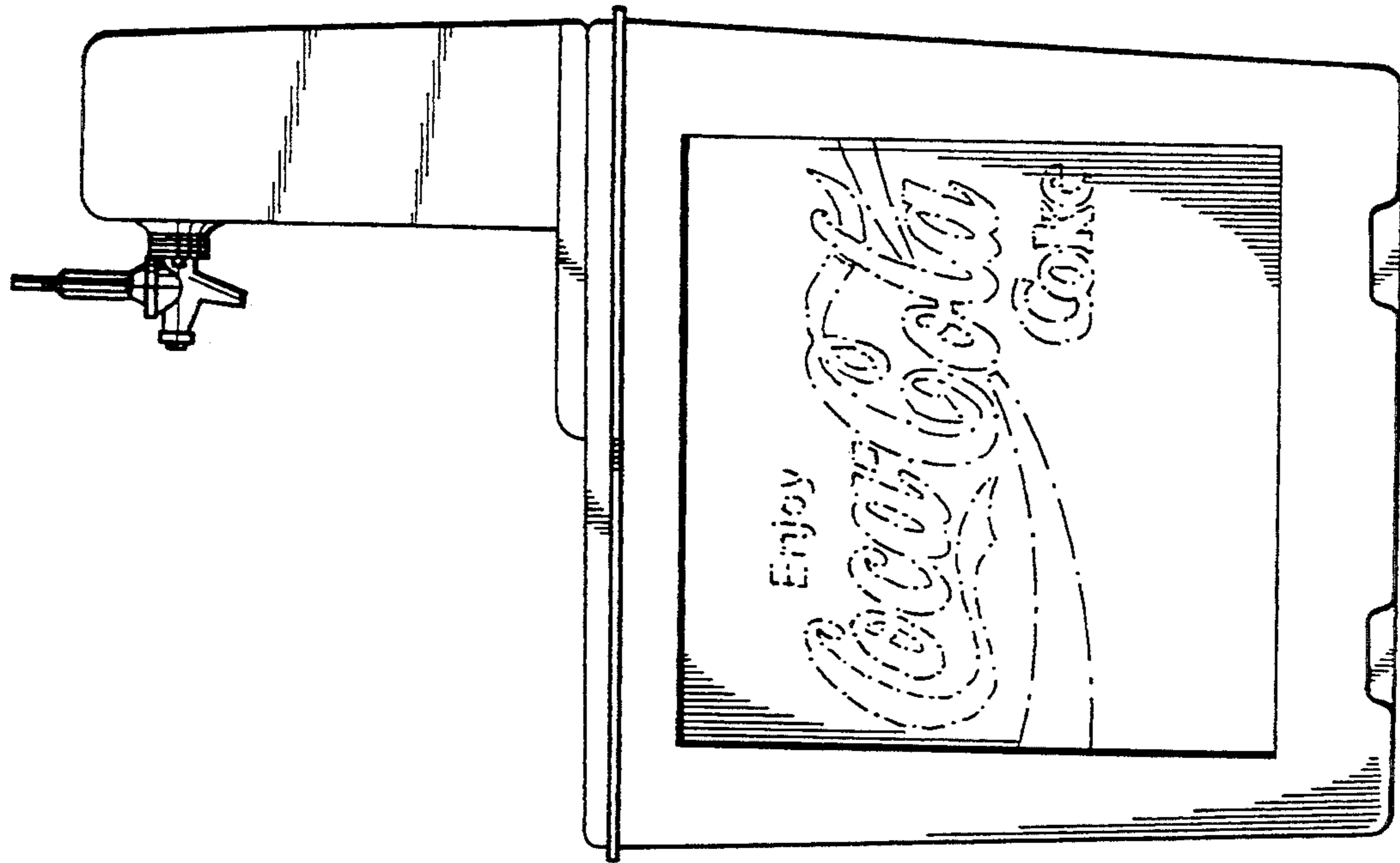
**DESCRIPTION**

FIG. 1 is a front right side perspective view of a dispenser cooler showing my new design; FIG. 2 is a front elevational view thereof; FIG. 3 is a side elevational view thereof; FIG. 4 is a rear elevational view thereof; FIG. 5 is a top plan view thereof; FIG. 6 is a bottom plan view thereof; and, FIG. 7 is a top front right side perspective view showing the cooler in a disassembled state. The broken line showing of coca cola surface decoration in FIGS. 1, 2, 3, 4 and 7 is for illustrative purposes only and forms no part of the claimed design.

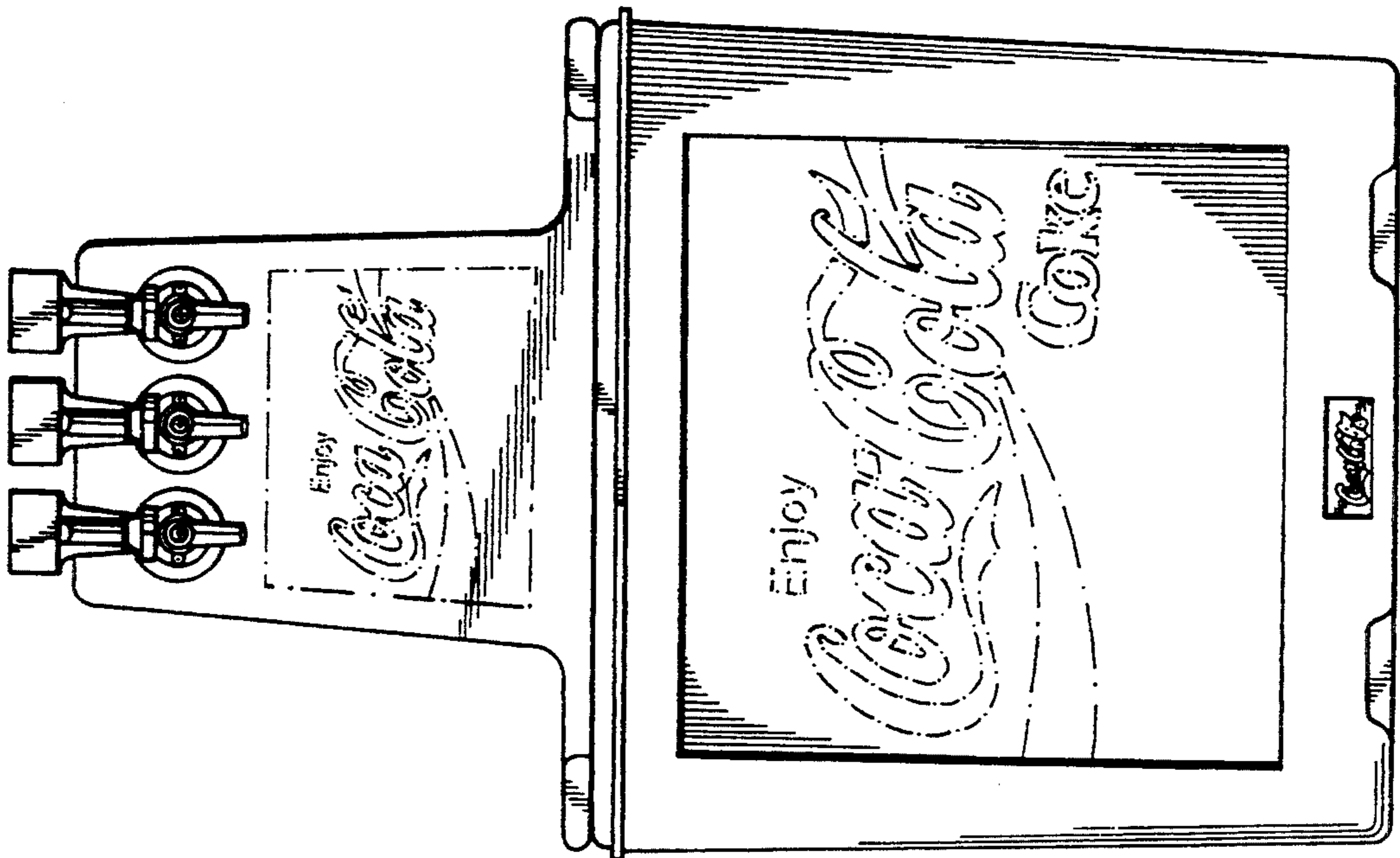




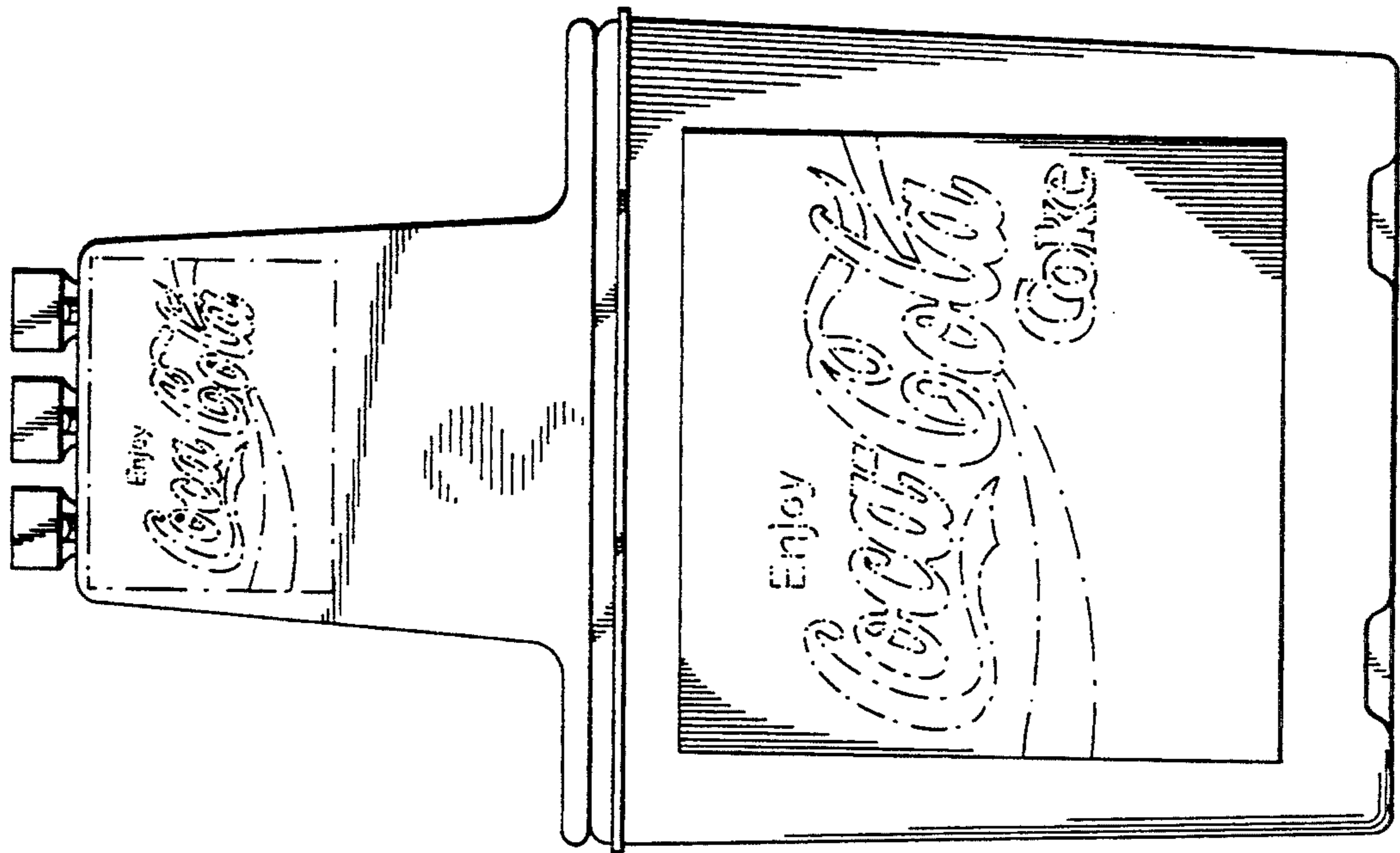
**FIG 1**



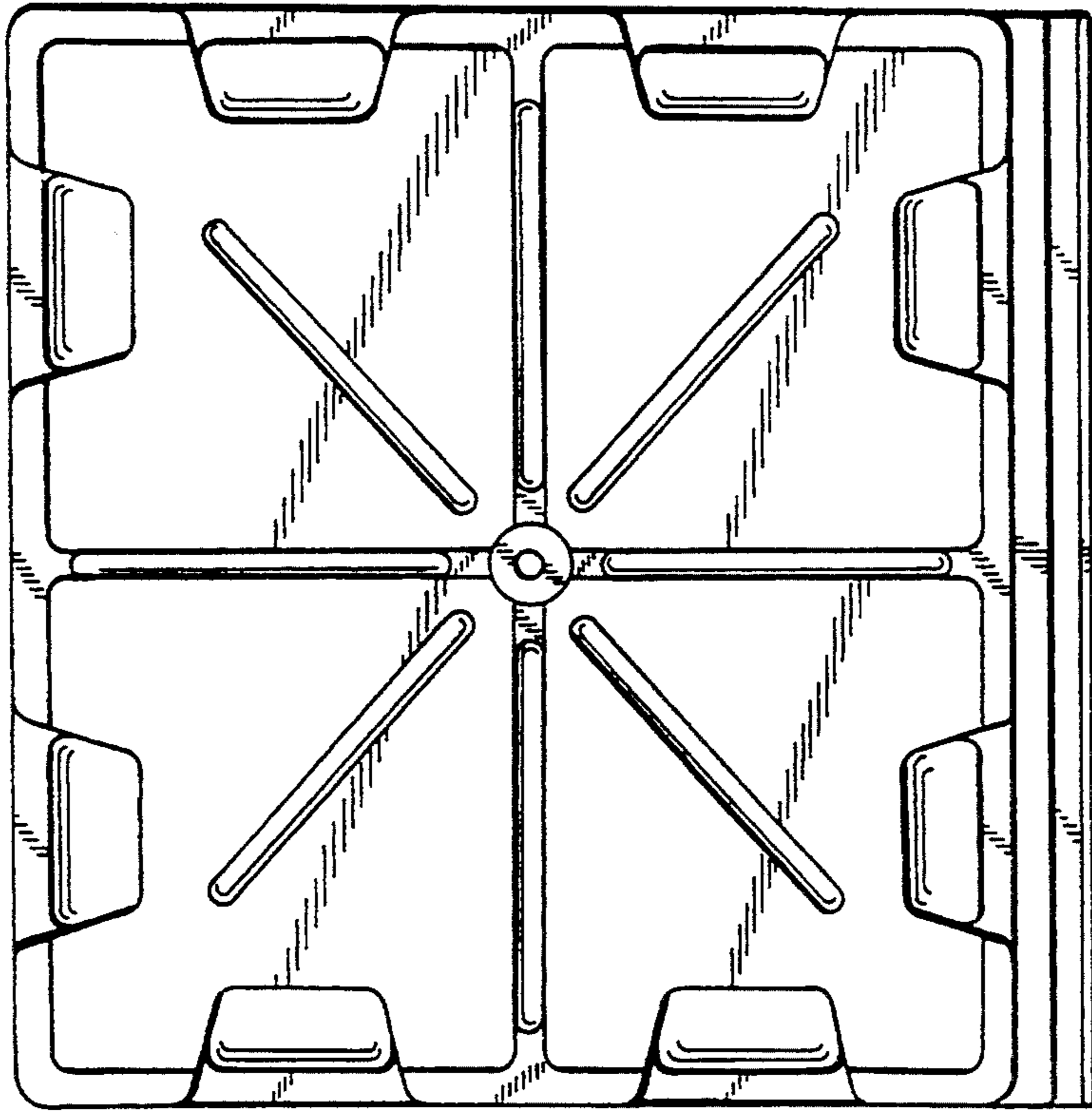
**FIG 3**



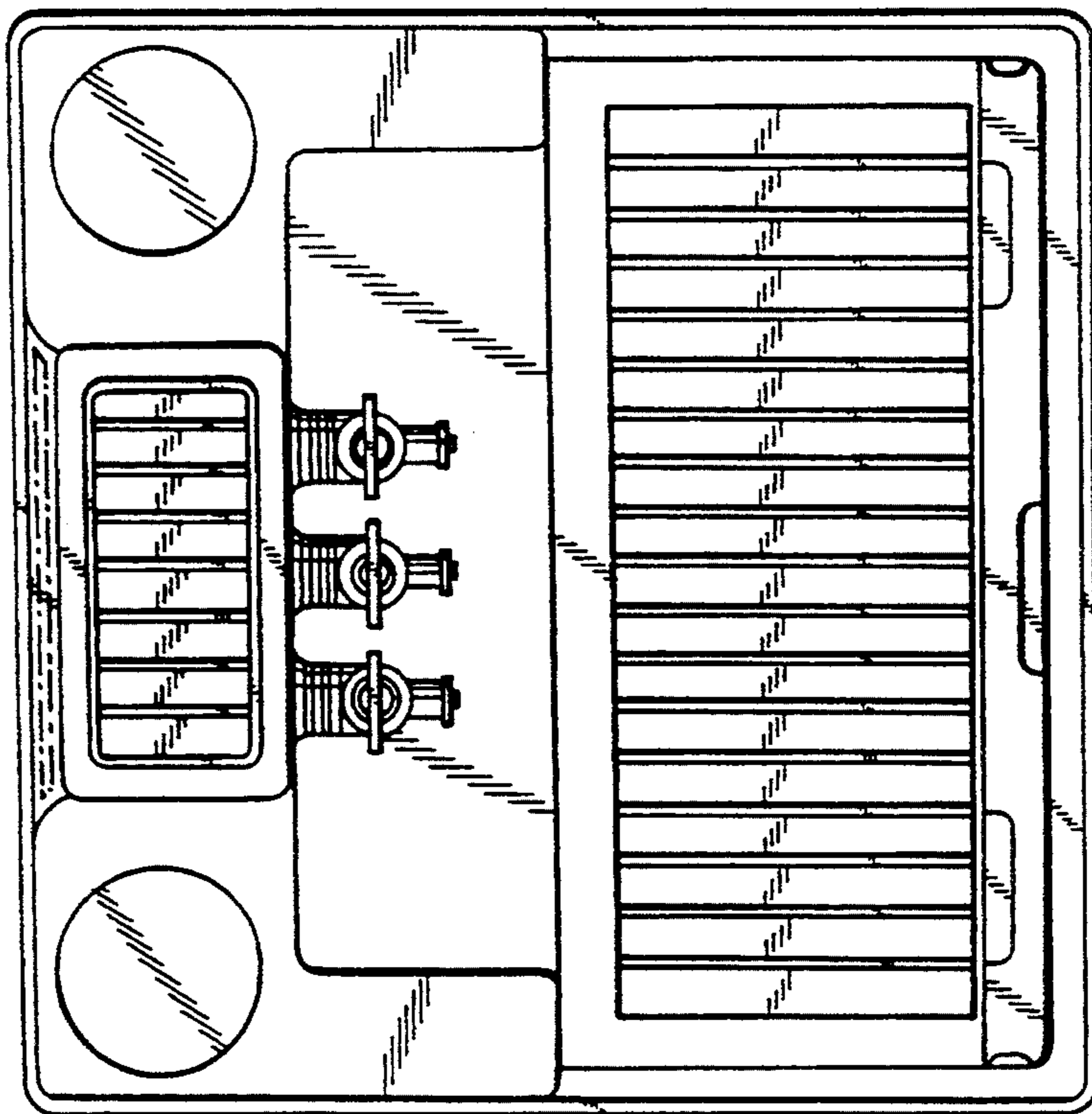
**FIG 2**



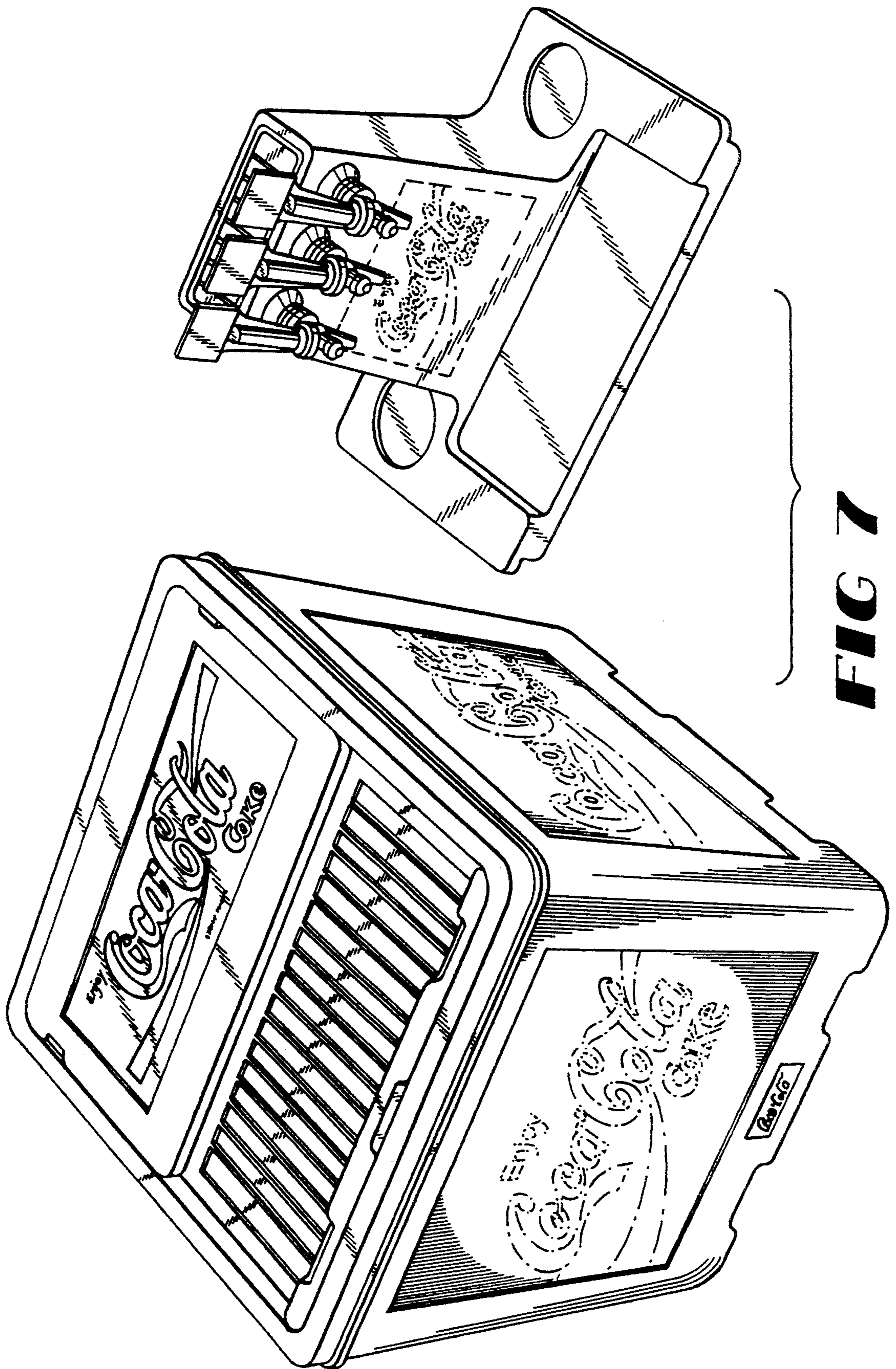
**FIG 4**



**FIG 6**



**FIG 5**



**FIG 7**