



US00D359370S

United States Patent [19]

[11] Patent Number: **Des. 359,370**

Tabor

[45] Date of Patent: **** Jun. 13, 1995**

[54] **FLASHLIGHT**

[75] Inventor: **Marilyn Tabor, Cambridge, Mass.**

[73] Assignee: **Blue Tiger Corporation, Cambridge, Mass.**

[**] Term: **14 Years**

[21] Appl. No.: **18,764**

[22] Filed: **Feb. 15, 1994**

[52] U.S. Cl. **D26/37**

[58] Field of Search **D26/37-50;**
 362/136, 156, 157-158, 163, 171-173, 178,
 181-183, 109, 188-189, 192, 194, 196-197,
 200-206, 257, 261-262

4,210,953 7/1980 Stone 362/189
 4,392,186 7/1983 Cziment 362/116
 4,408,261 10/1983 Polakoff 362/104
 4,459,646 7/1984 Drane 362/188
 4,774,638 9/1988 Caires 362/156

Primary Examiner—Brian N. Vinson
Assistant Examiner—Robin V. Taylor
Attorney, Agent, or Firm—Lahive & Cockfield

[57] CLAIM

The ornamental design for a flashlight, as shown and described.

DESCRIPTION

FIG. 1 is a front and right side perspective view of a flashlight showing my new design;
 FIG. 2 is a back and right side perspective view thereof;
 FIG. 3 is a top plan view thereof;
 FIG. 4 is a bottom plan view thereof;
 FIG. 5 is a right side elevation thereof, the left side being a mirror image of that shown;
 FIG. 6 is a front elevation view thereof; and,
 FIG. 7 is a back elevation view thereof.

[56] **References Cited**

U.S. PATENT DOCUMENTS

1,489,431	4/1924	Drouillat	362/192
1,866,600	7/1932	Rauch	362/189
2,249,692	7/1941	Gelardin	362/200
3,359,411	12/1967	Schwartz	362/189
4,101,955	7/1978	DuNah	362/104

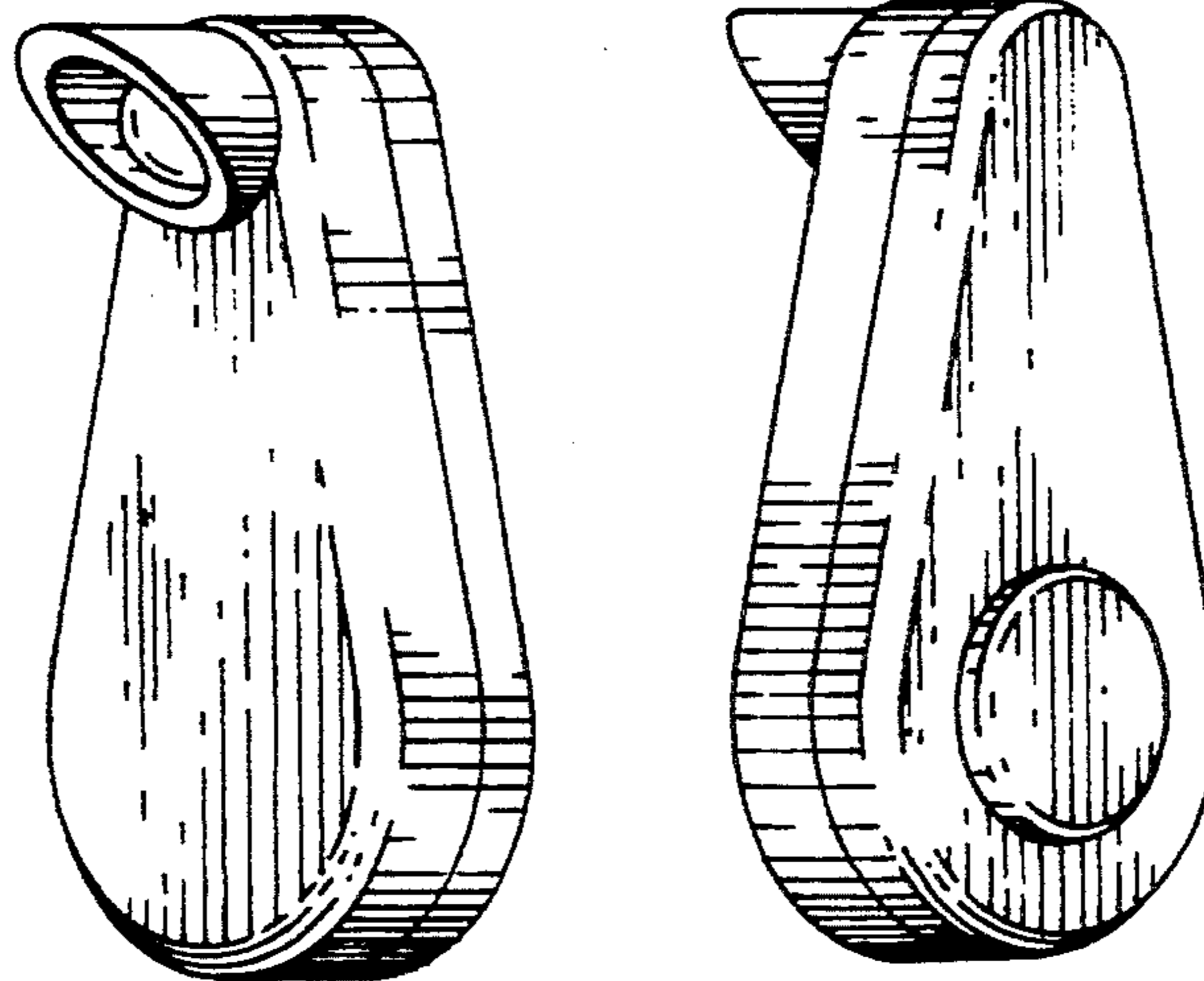

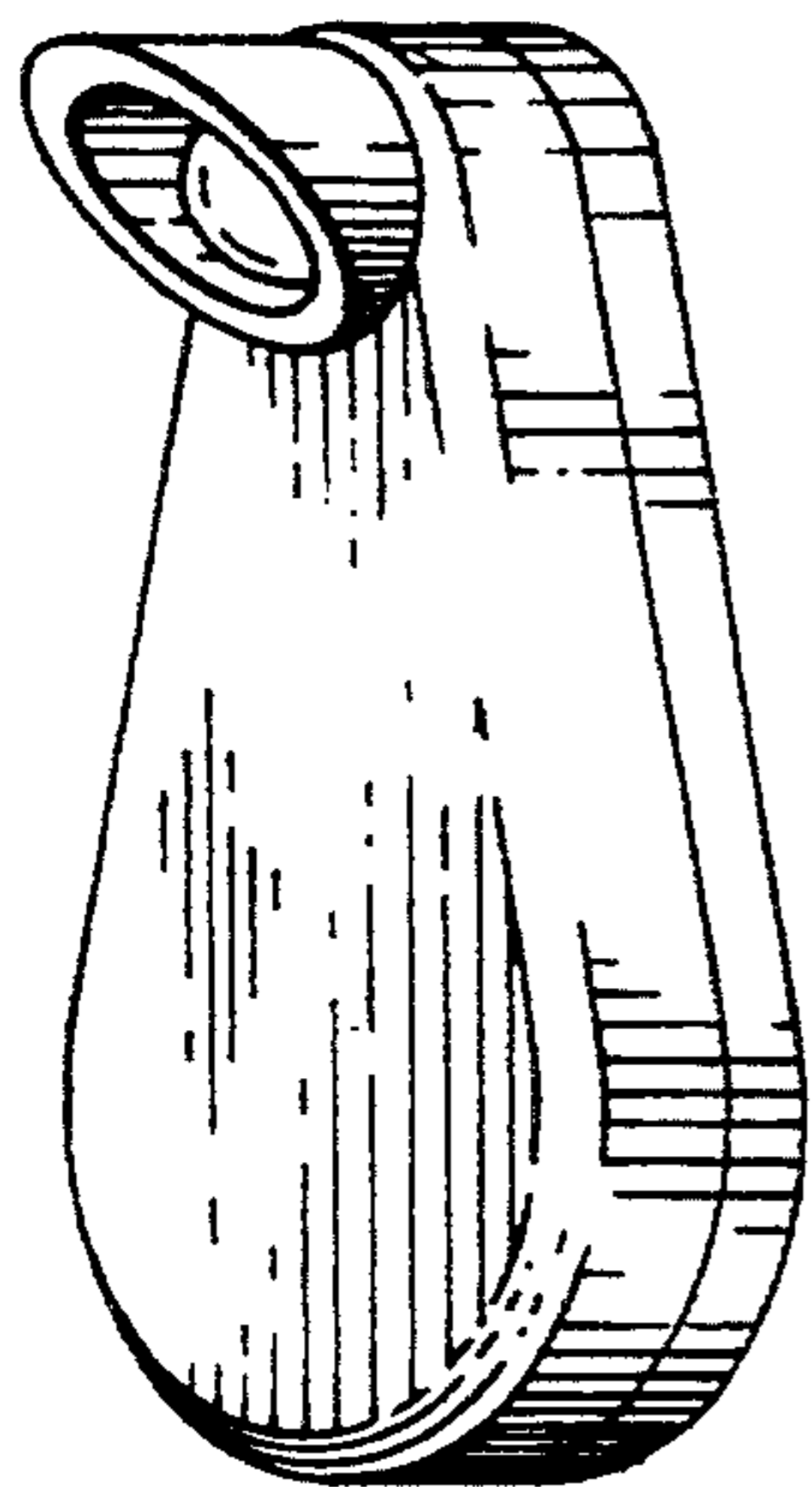

FIG. 1

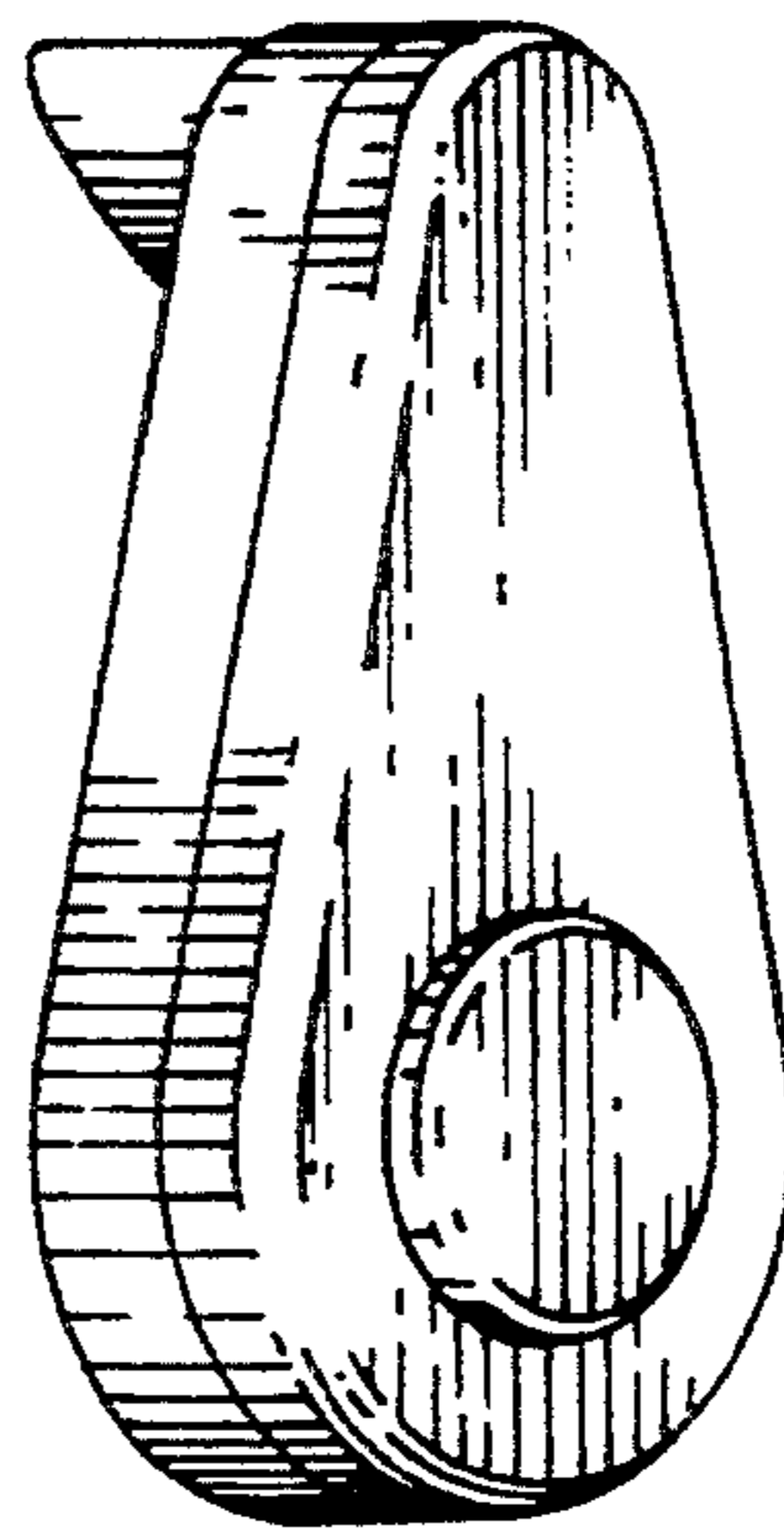

FIG. 2

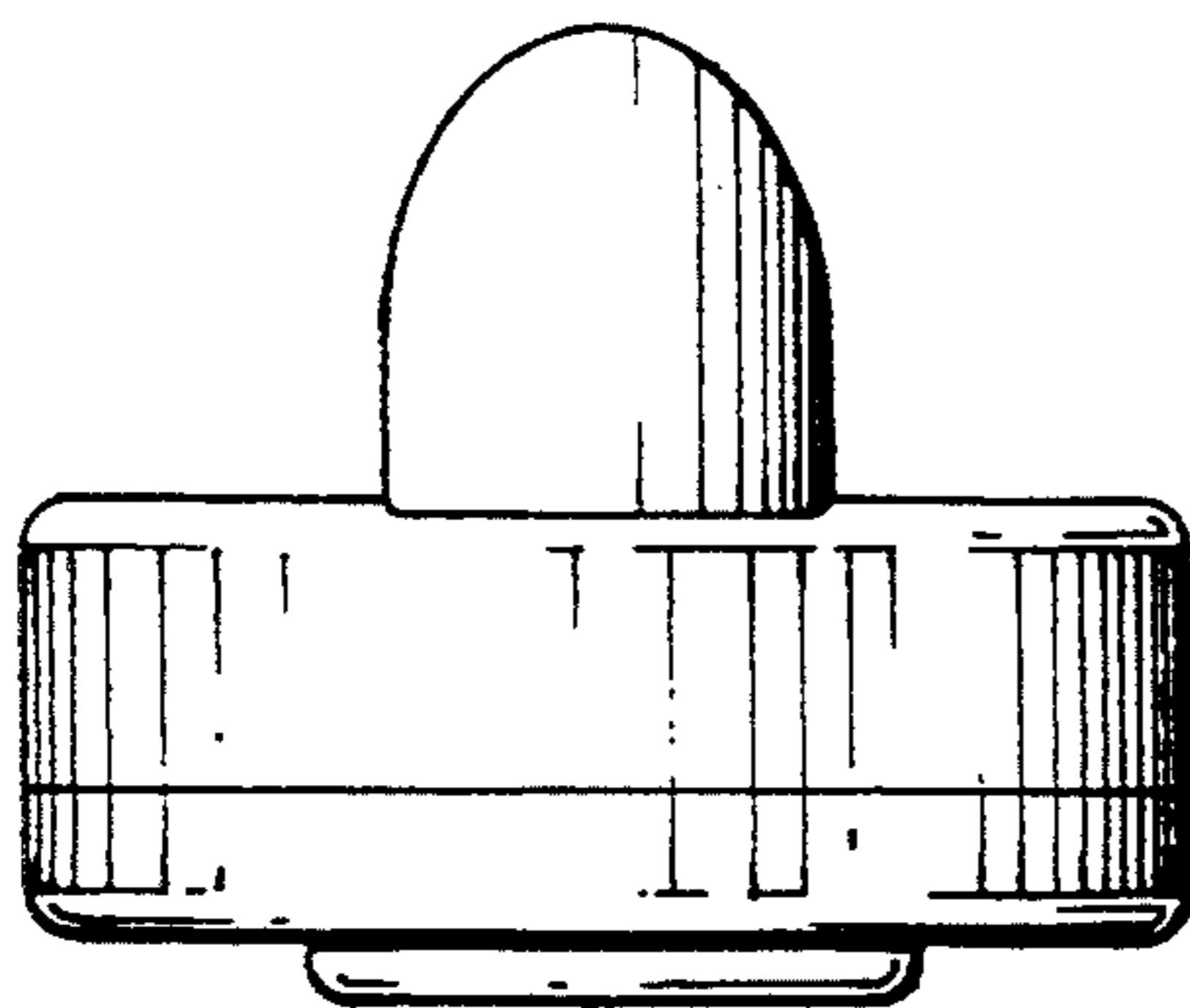

FIG. 3

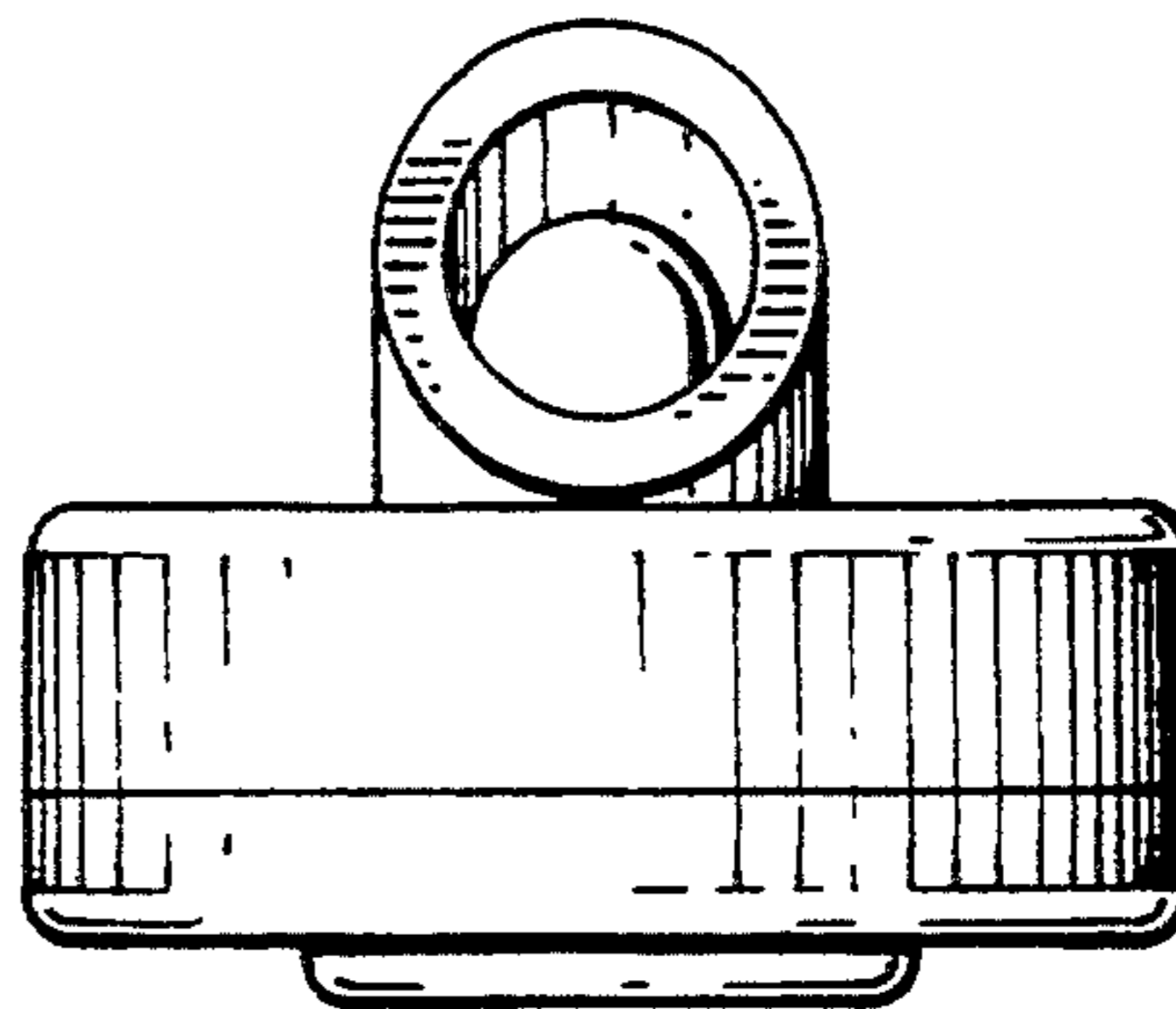

FIG. 4

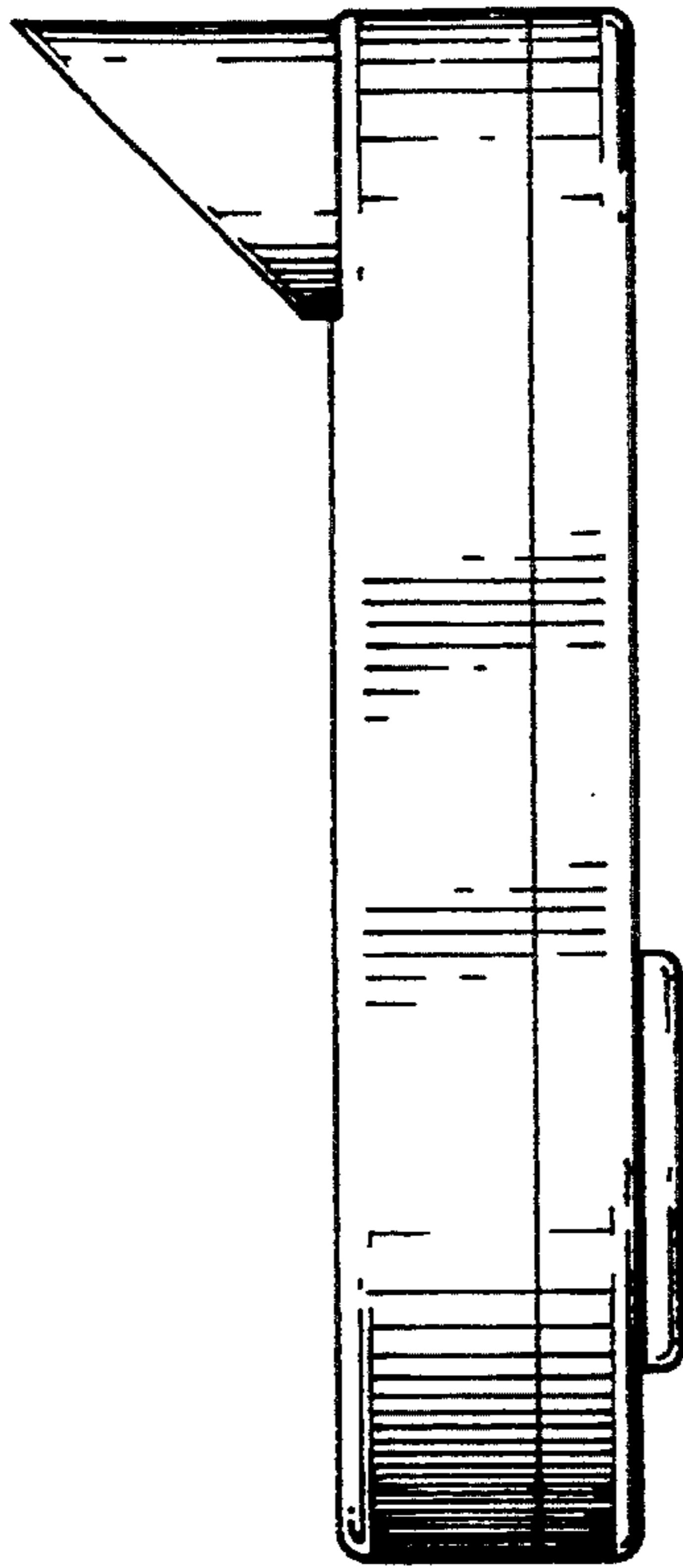

FIG. 5

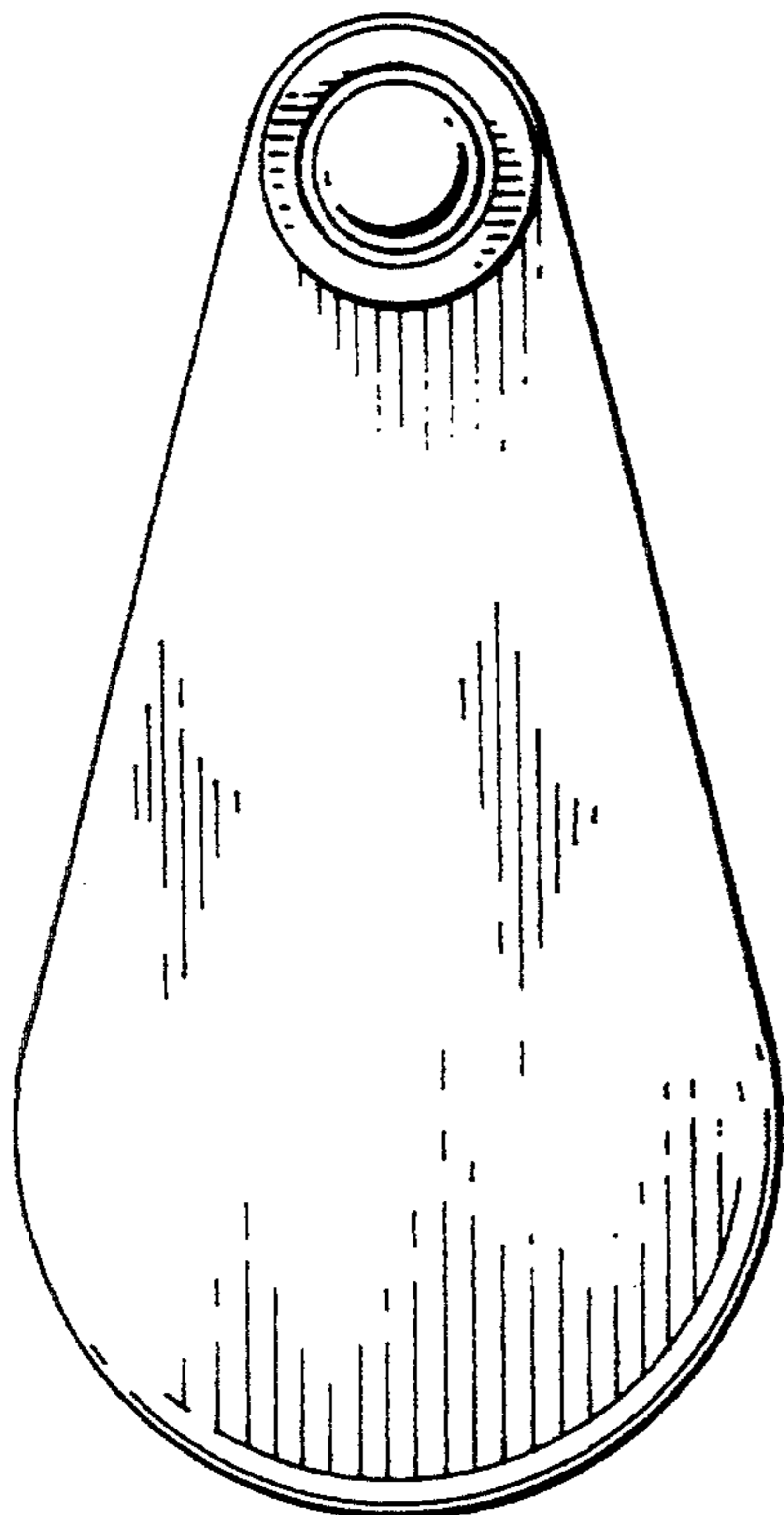

FIG. 6

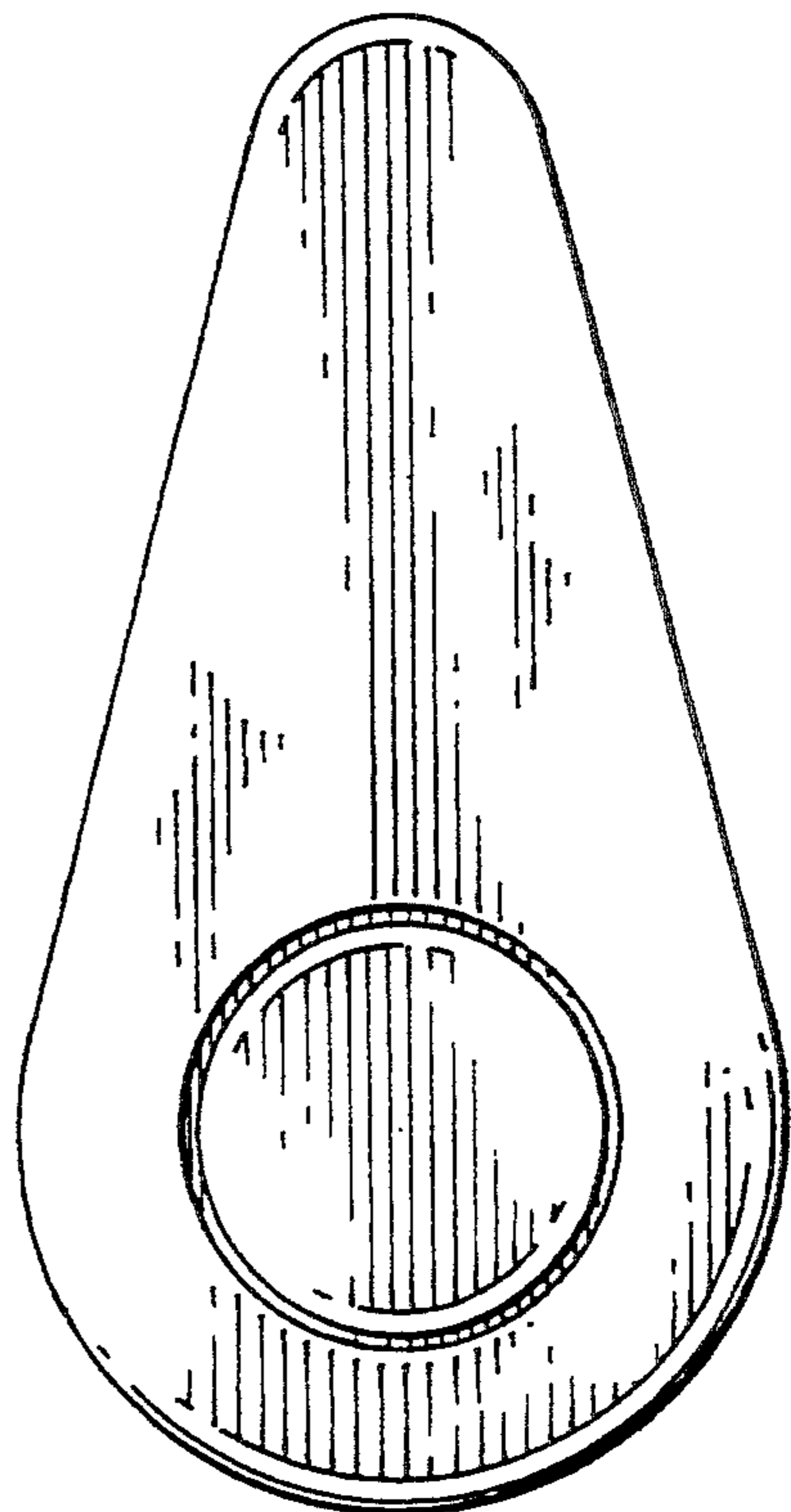

FIG. 7