



US00D359175S

# United States Patent [19]

Arthur, Jr.

[11] Patent Number: **Des. 359,175**

[45] Date of Patent: **\*\* Jun. 13, 1995**

[54] CHAIR

[75] Inventor: **James R. Arthur, Jr.**, Monarch Beach, Calif.

[73] Assignee: **Josan Corporation**, Anaheim, Calif.

[\*\*] Term: **14 Years**

[21] Appl. No.: **11,822**

[22] Filed: **Aug. 13, 1993**

[52] U.S. Cl. .... **D6/376; D6/379**

[58] Field of Search ..... **D6/334, 370, 374, 376, D6/379, 380, 500, 501, 502; 297/411.42**

[56] **References Cited**

**U.S. PATENT DOCUMENTS**

D. 278,104	3/1985	Dunbar et al. ....	D6/379
D. 288,635	3/1987	Vidal .....	D6/379
D. 291,035	7/1987	Strousse et al. ....	D6/379 X
D. 298,090	10/1988	Kaminski .....	D6/379
D. 317,536	6/1991	Hess .....	D6/379 X
D. 337,449	7/1993	Bertoldi .....	D6/379

**OTHER PUBLICATIONS**

Designers Furniture Center International, 1985, p. 6, chair #122-036 at top right.

U.S. Seating Products, Mar. 1, 1989, p. 2, chair #1000 at top left.

U.S. Seating Products, Mar. 1, 1989, p. 4, chair #3600, bottom center.

*Primary Examiner*—Alan P. Douglas

*Assistant Examiner*—Gary D. Watson

*Attorney, Agent, or Firm*—Pollock, Vande Sande & Priddy

[57] **CLAIM**

The ornamental design for a chair, as shown and described.

**DESCRIPTION**

FIG. 1 is a perspective view of the preferred embodiment of the new design;

FIG. 2 is a front view of the embodiment of FIG. 1;

FIG. 3 is a top view of the embodiment of FIG. 1;

FIG. 4 is a side view of the embodiment of FIG. 1;

FIG. 5 is a bottom view of the embodiment of FIG. 1; and,

FIG. 6 is a back view of the embodiment of FIG. 1.

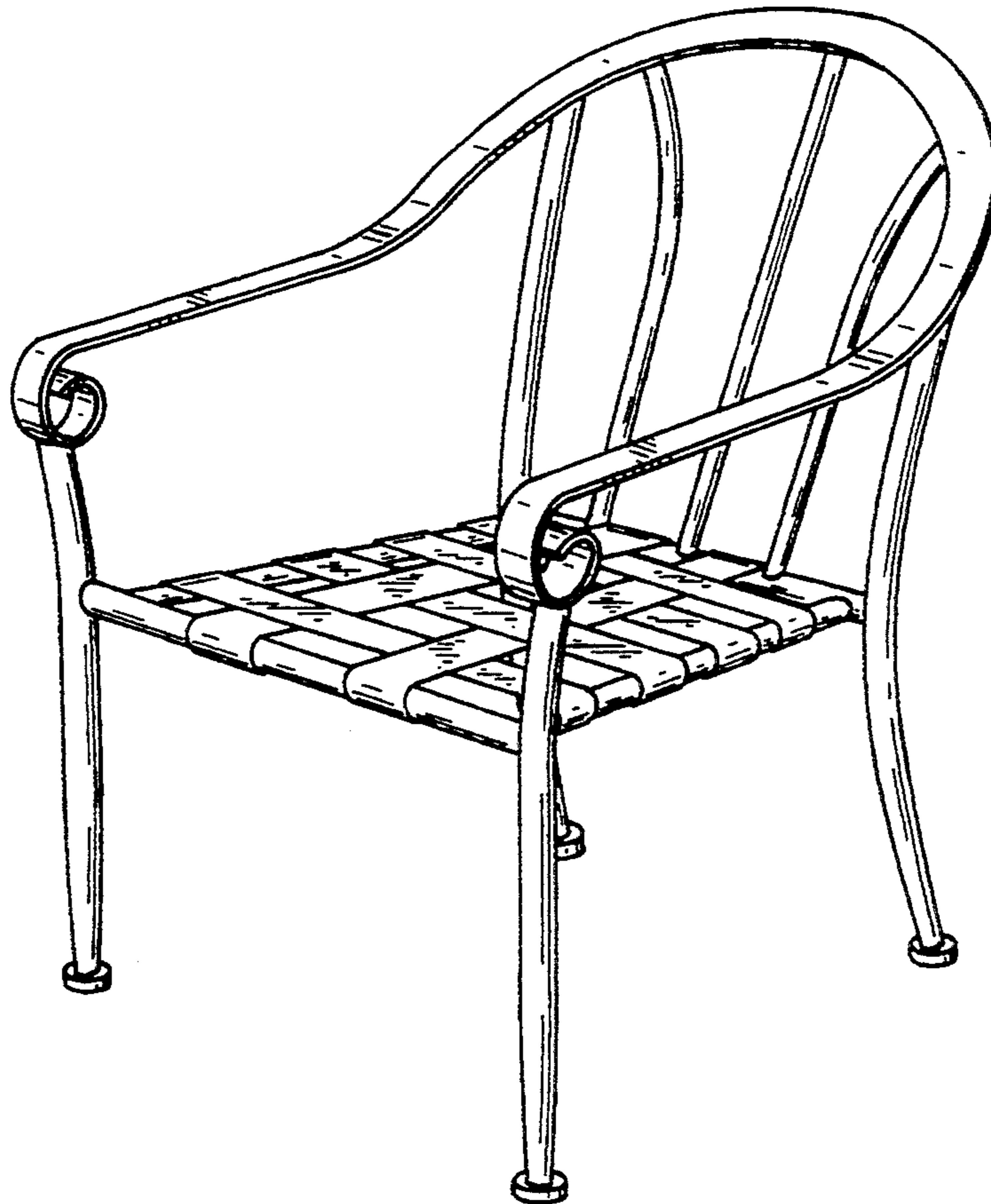

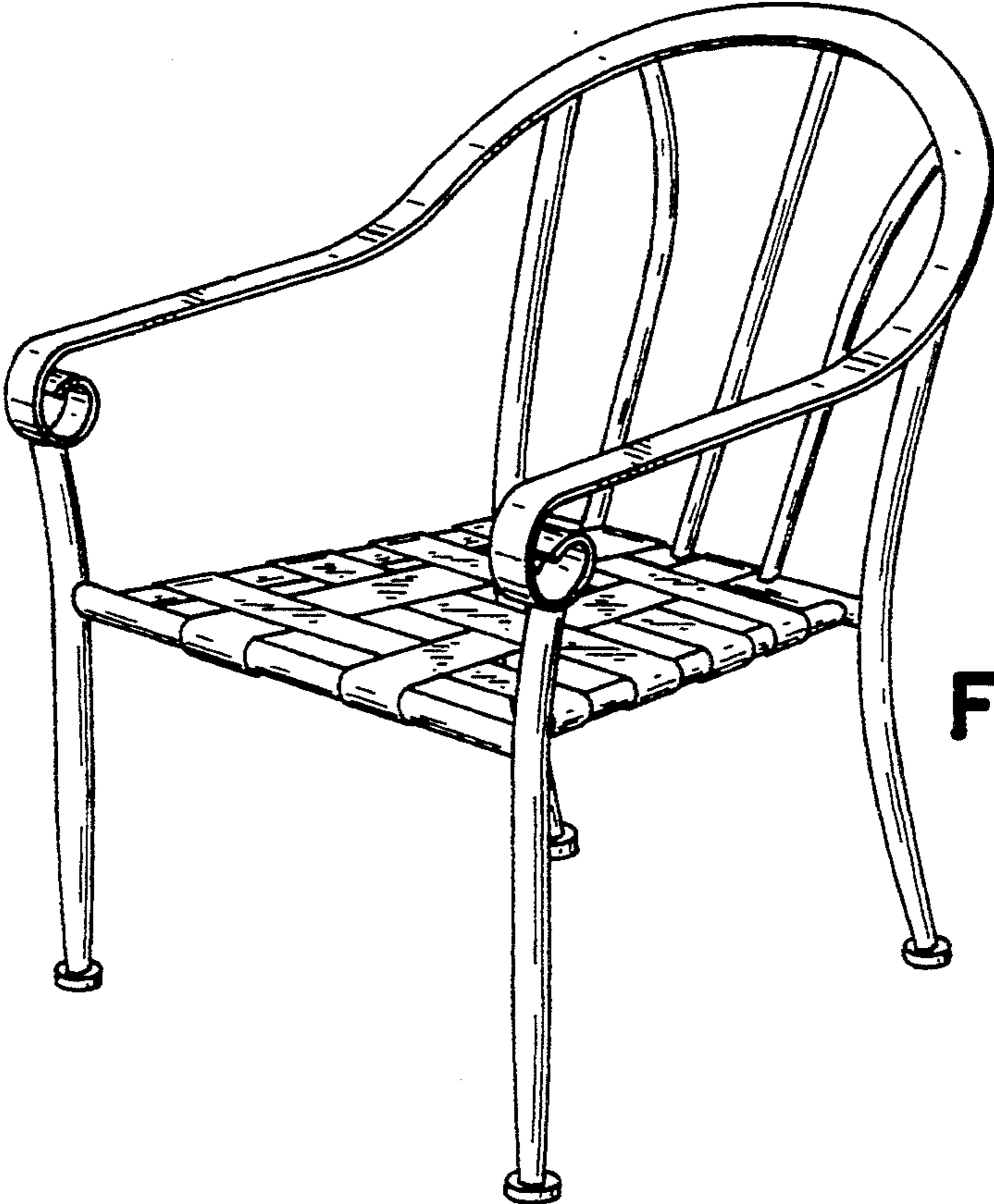

FIG. 1

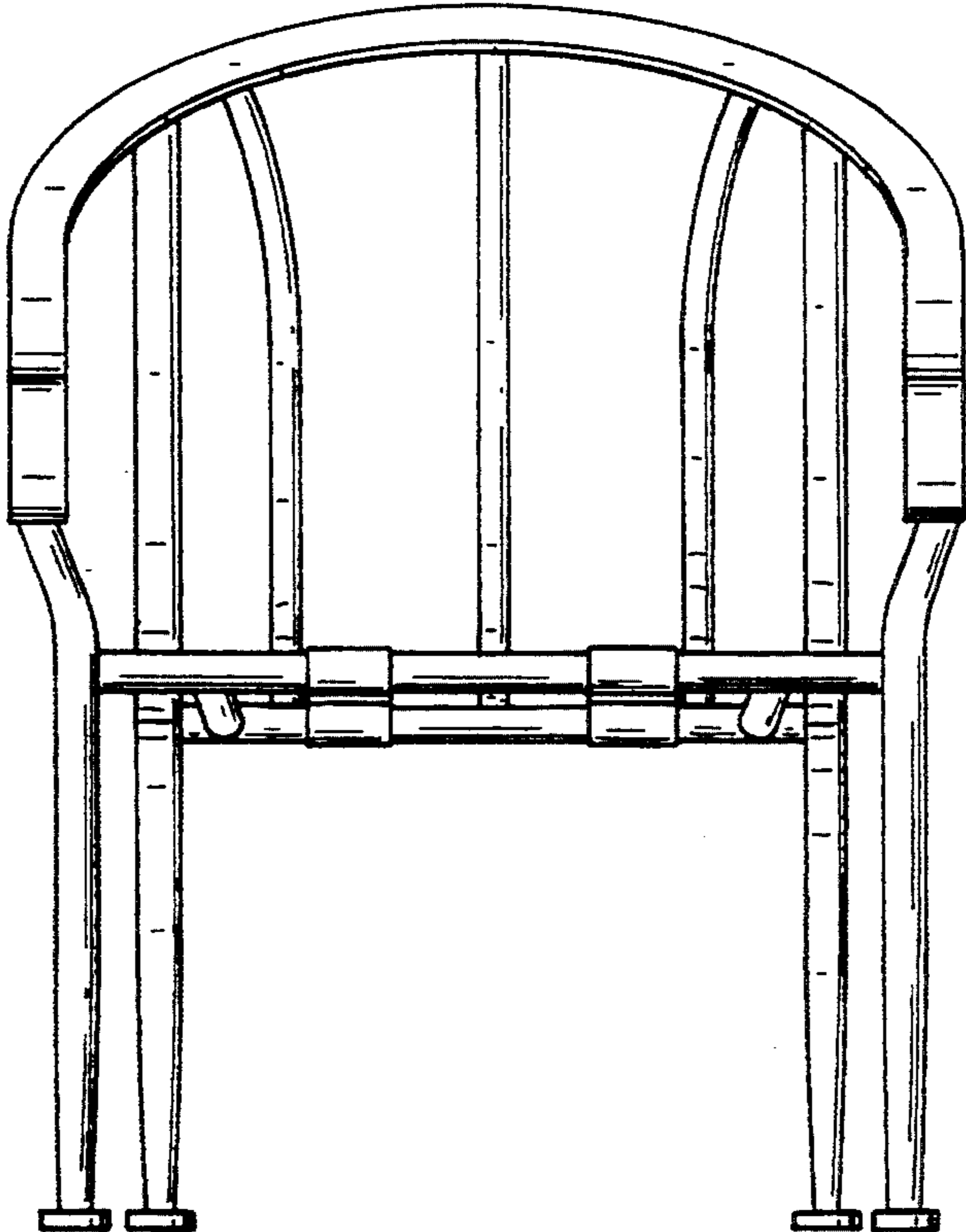

FIG. 2

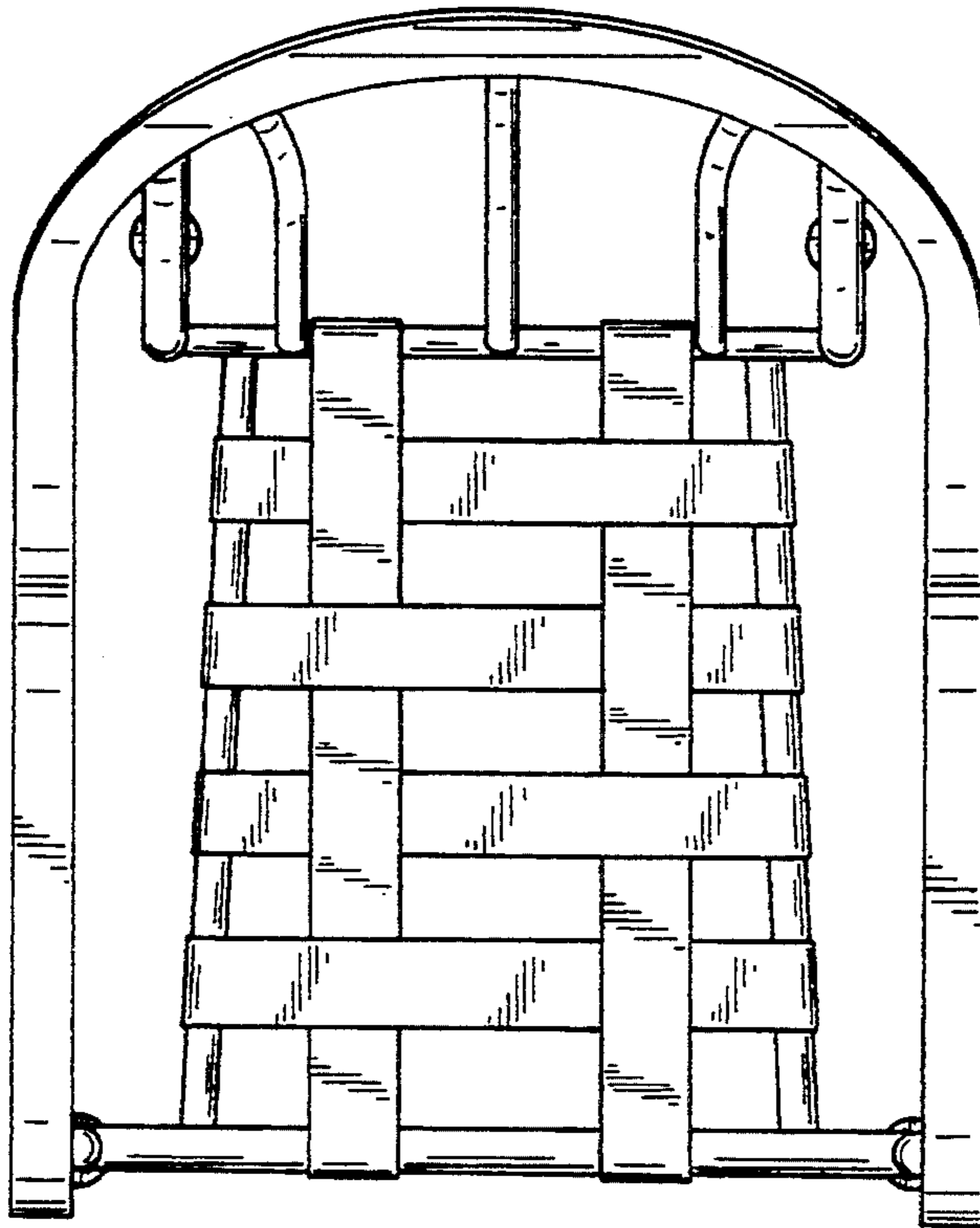

FIG. 3

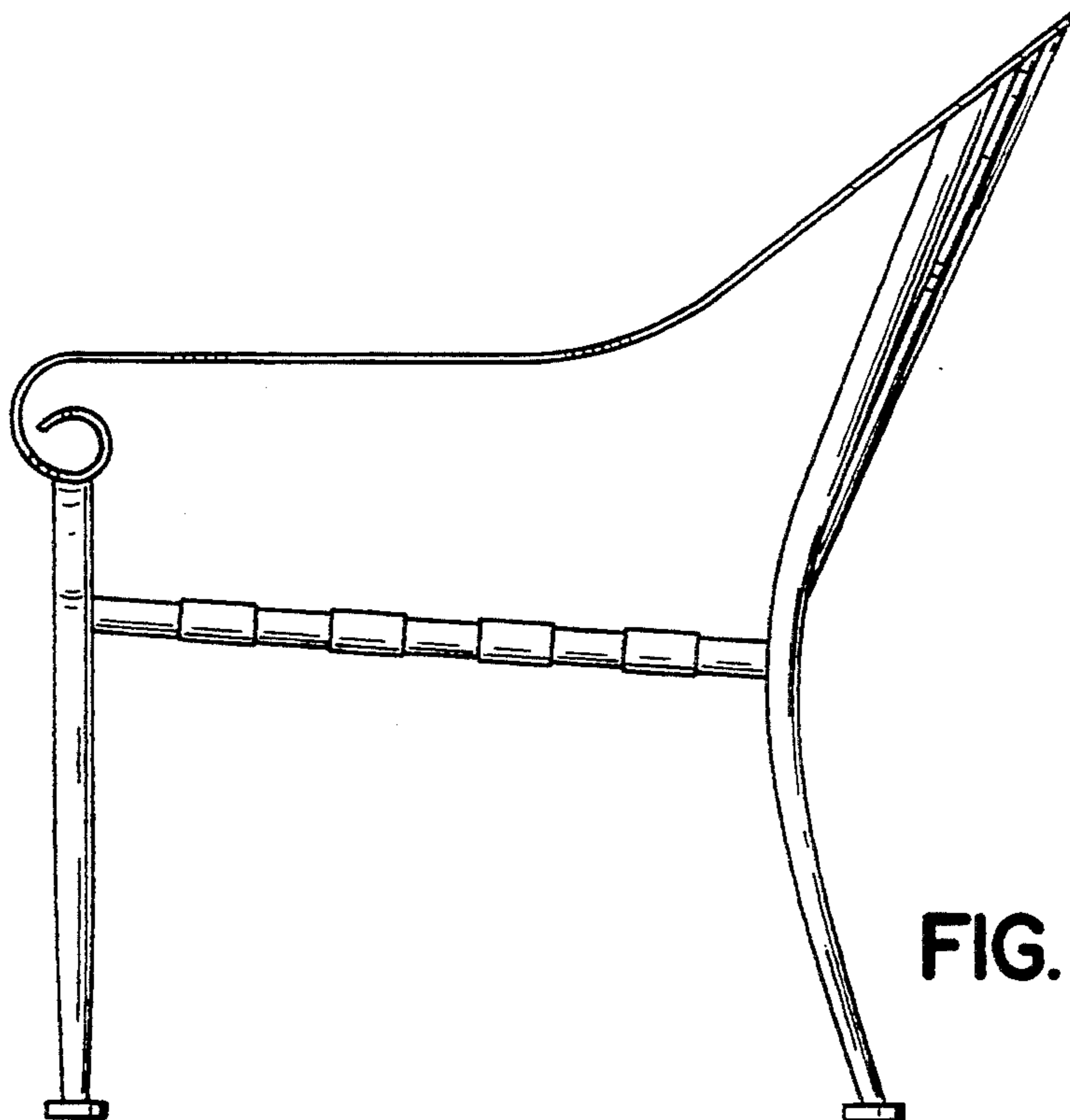

FIG. 4

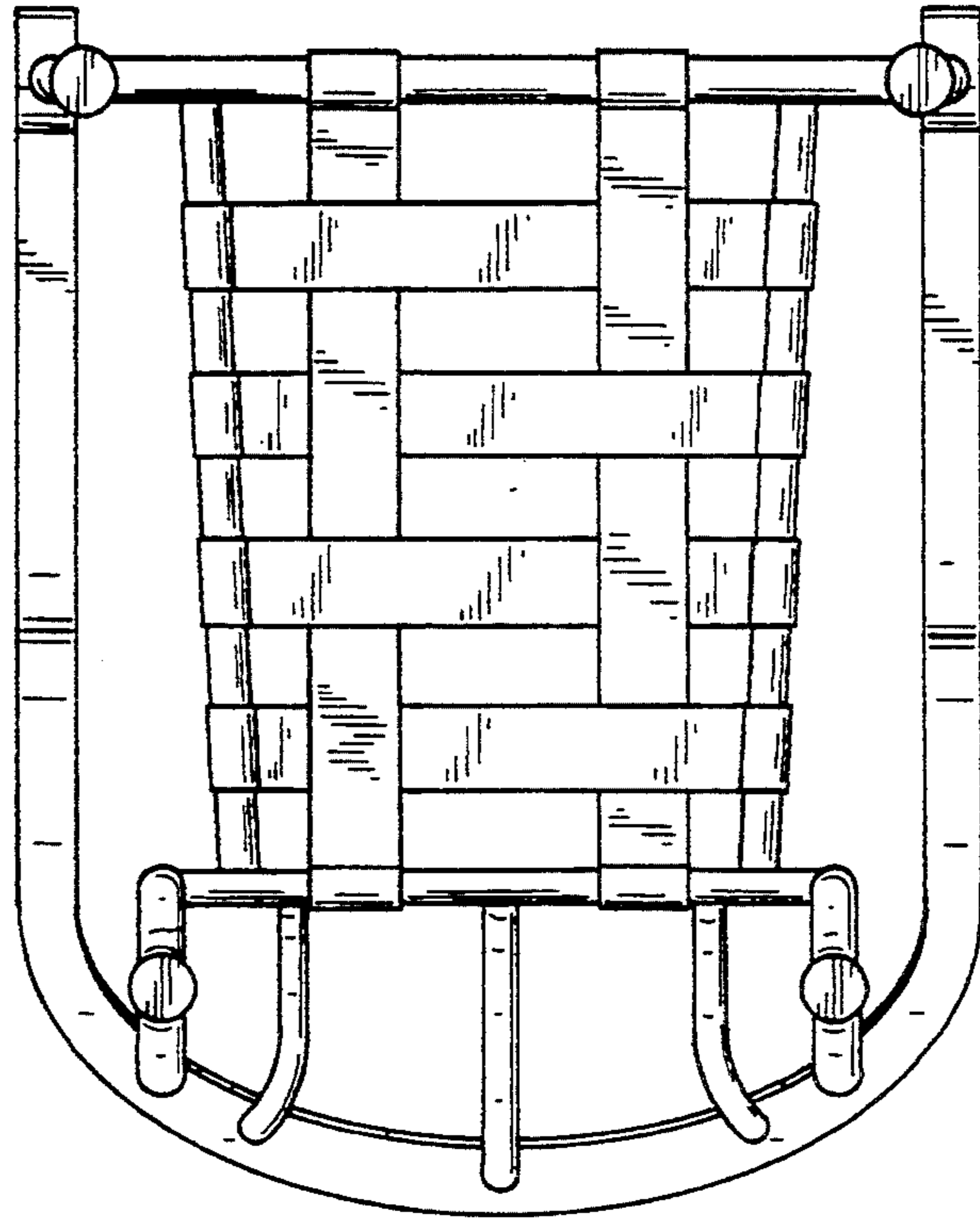

FIG. 5

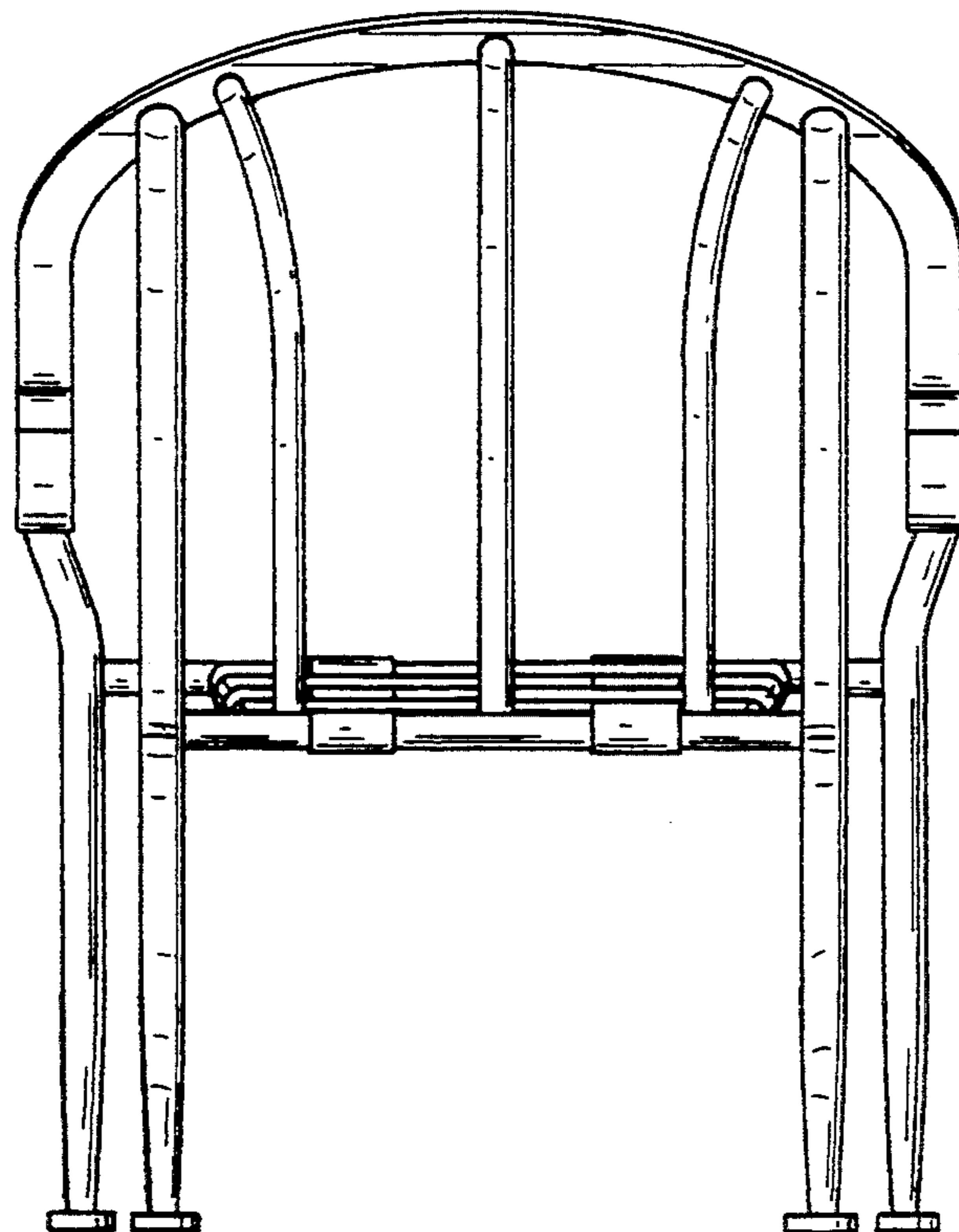

FIG. 6