



US00D359101S

United States Patent [19]

Kuo

[11] Patent Number: **Des. 359,101**

[45] Date of Patent: **** Jun. 6, 1995**

[54] **WATER SPRAY GUN**

[76] Inventor: **Awdu Kuo**, No. 10, Fang Tung Road, Wen Chien Tsun, Fang Yuan Hsiang, Changhua Hsien,

[**] Term: **14 Years**

[21] Appl. No.: **26,900**

[22] Filed: **Aug. 9, 1994**

[52] U.S. Cl. **D23/223**

[58] Field of Search **D23/213, 223-230; 239/394, 373, 414-415, 525-528, 300-302, 456-460**

[56] **References Cited**

U.S. PATENT DOCUMENTS

- D. 314,609 2/1991 Liaw D23/226
- D. 338,706 8/1993 Wang D23/223

- D. 340,762 10/1993 Wang D23/226
- 5,348,228 9/1994 Wang 239/394

Primary Examiner—James M. Gandy
Assistant Examiner—Robin V. Taylor
Attorney, Agent, or Firm—Bacon & Thomas

[57] **CLAIM**

The ornamental design for water spray gun, as shown and described.

DESCRIPTION

FIG. 1 is a perspective view of water spray gun showing my new design thereof;
FIG. 2 is a front elevational view thereof;
FIG. 3 is a rear elevational view thereof;
FIG. 4 is a left side elevational view thereof;
FIG. 5 is a right side elevational view thereof;
FIG. 6 is a top plan view thereof; and,
FIG. 7 is a bottom plan view thereof.

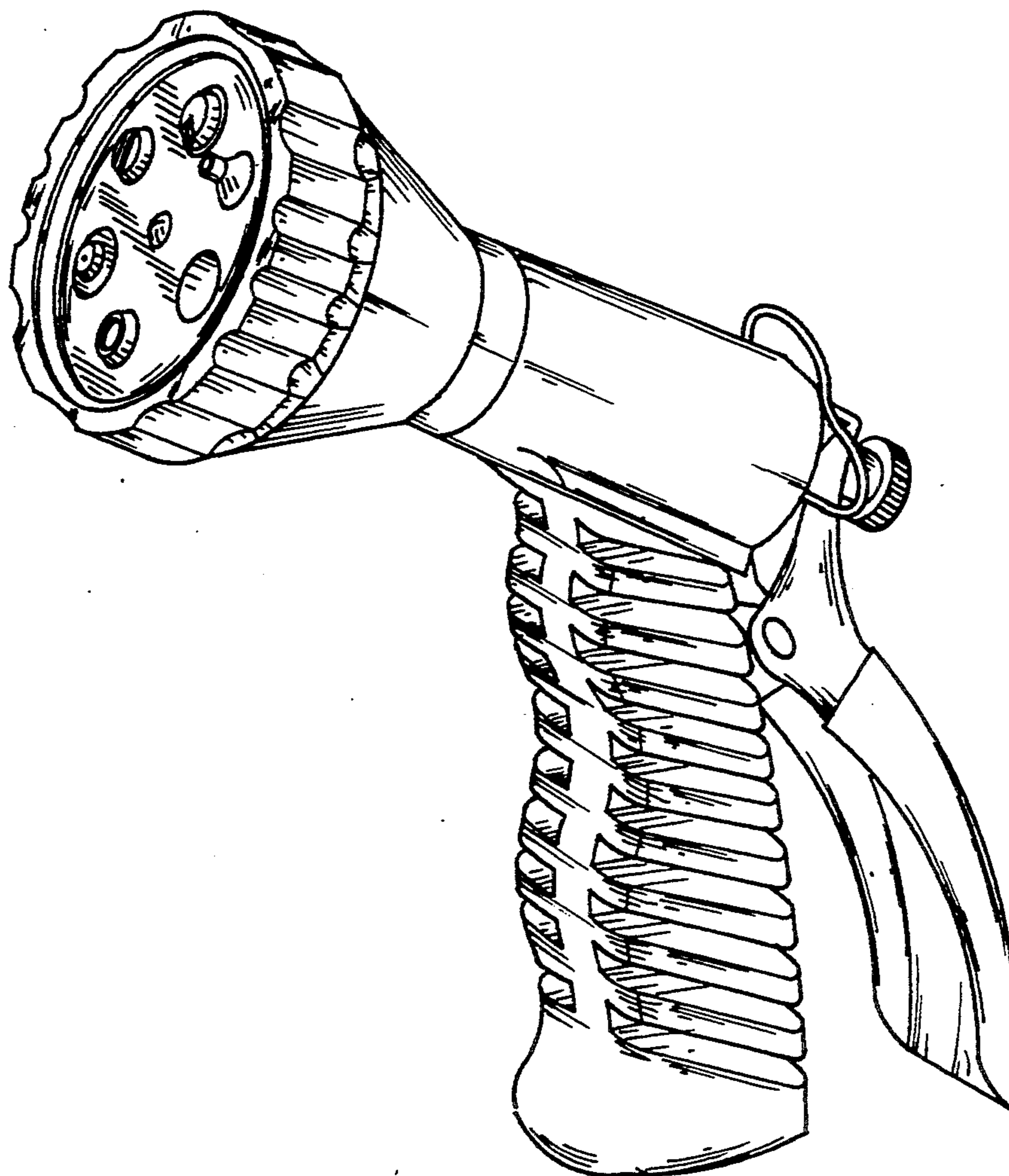

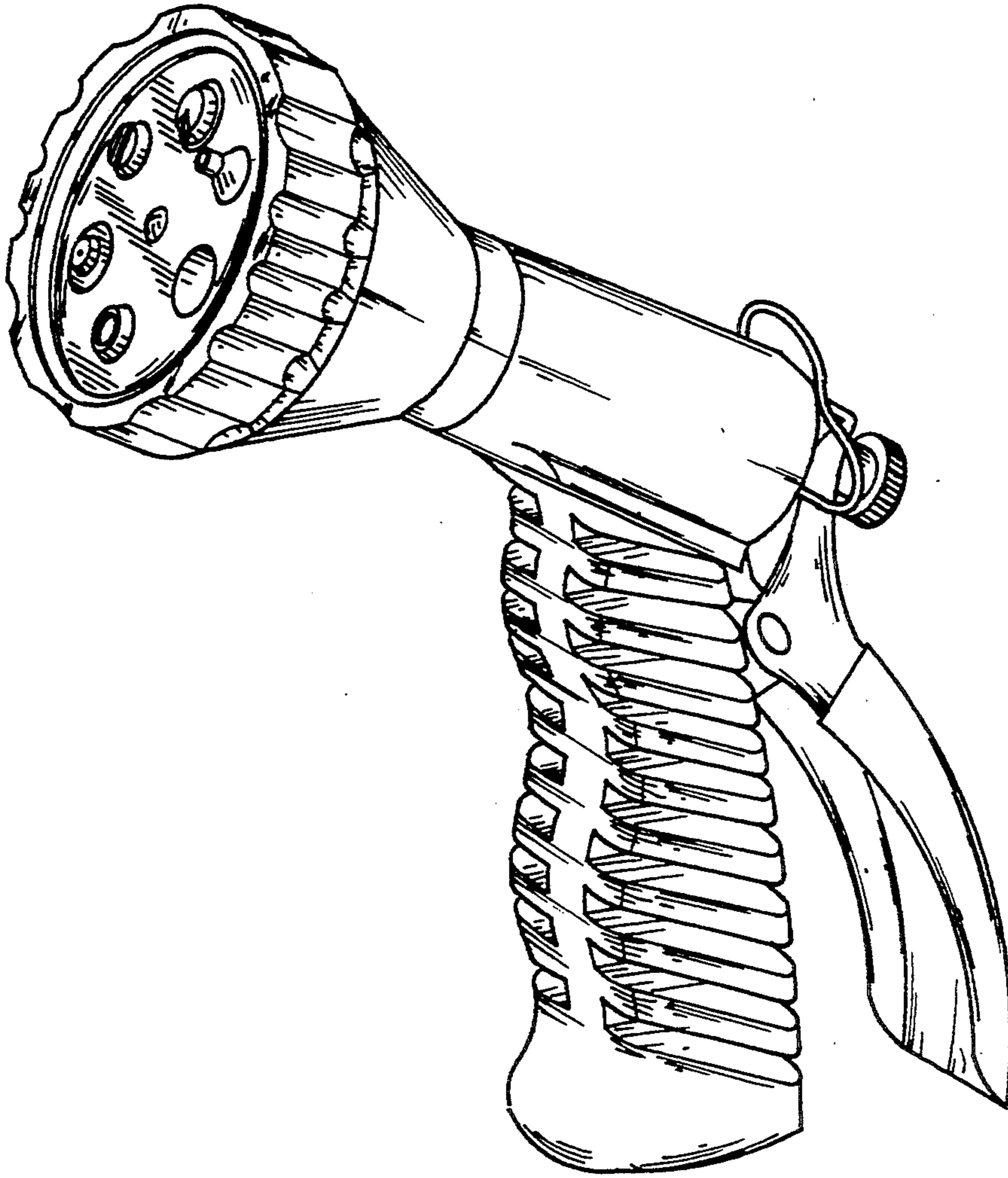

Fig.1

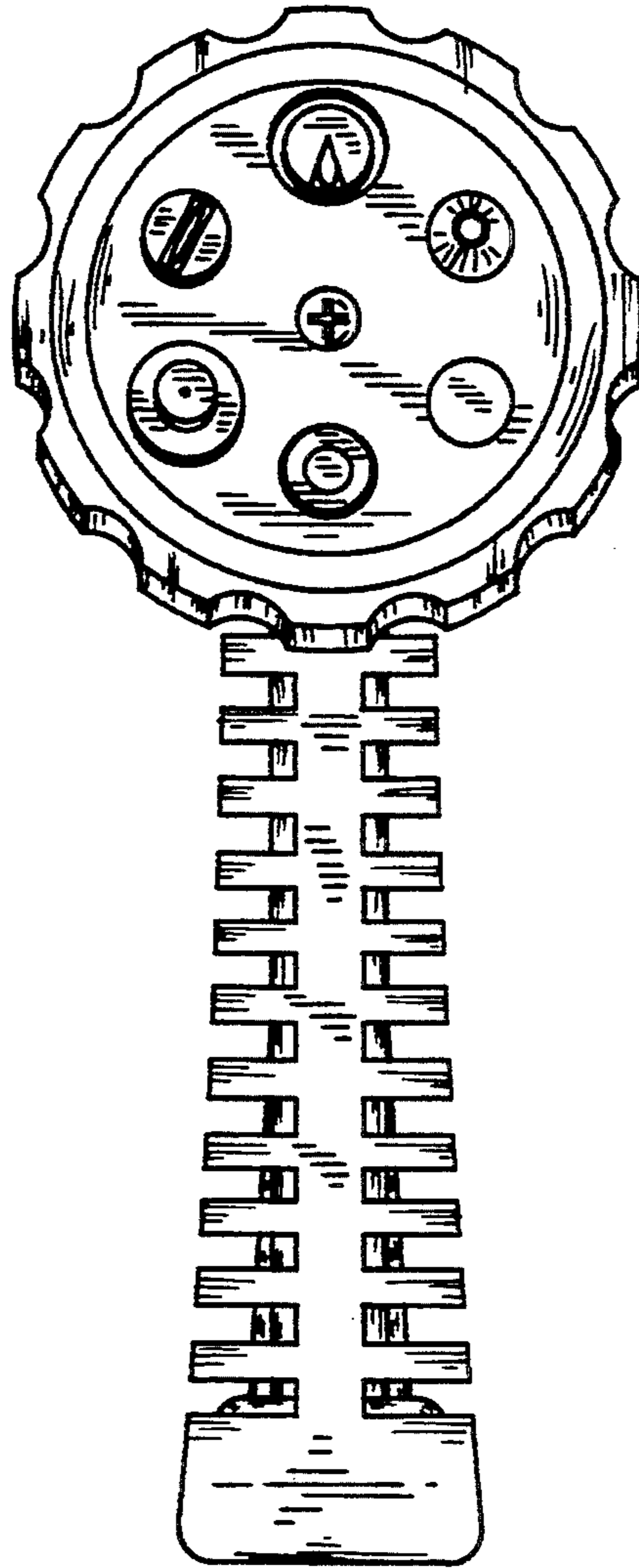

Fig.2

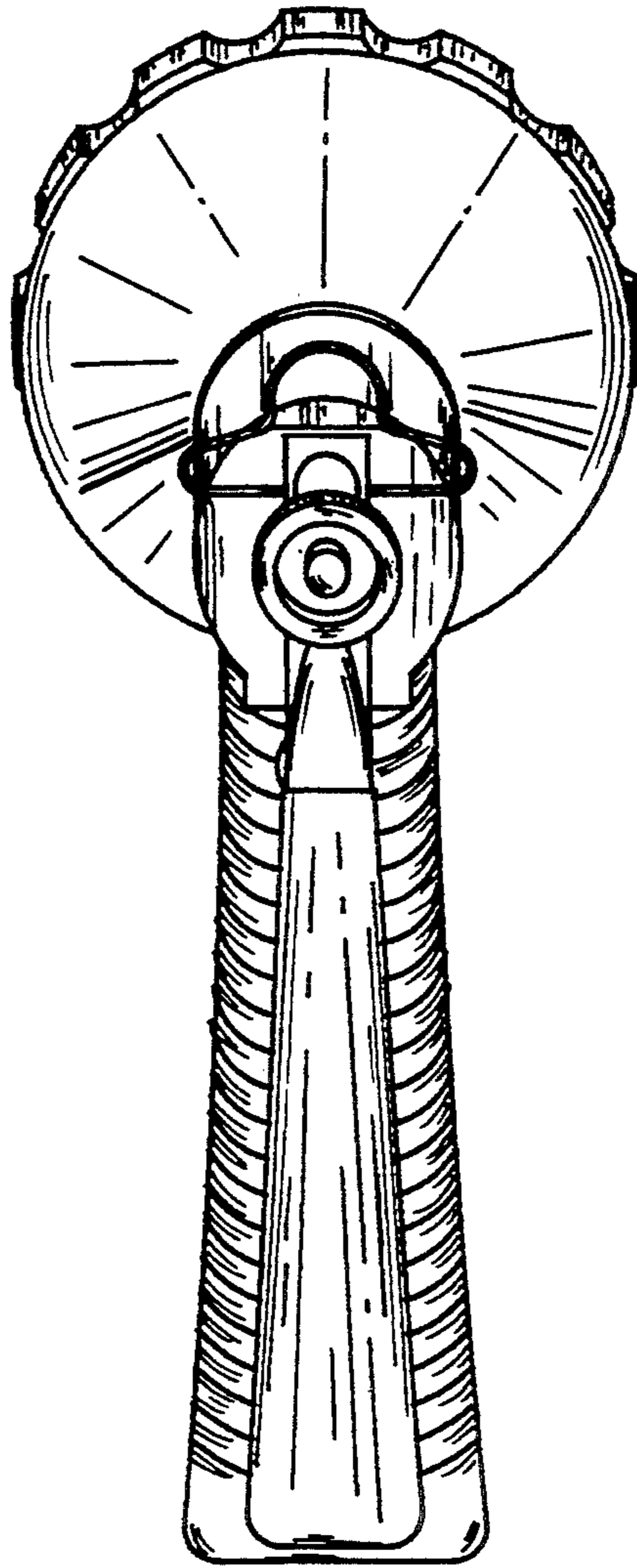

Fig.3

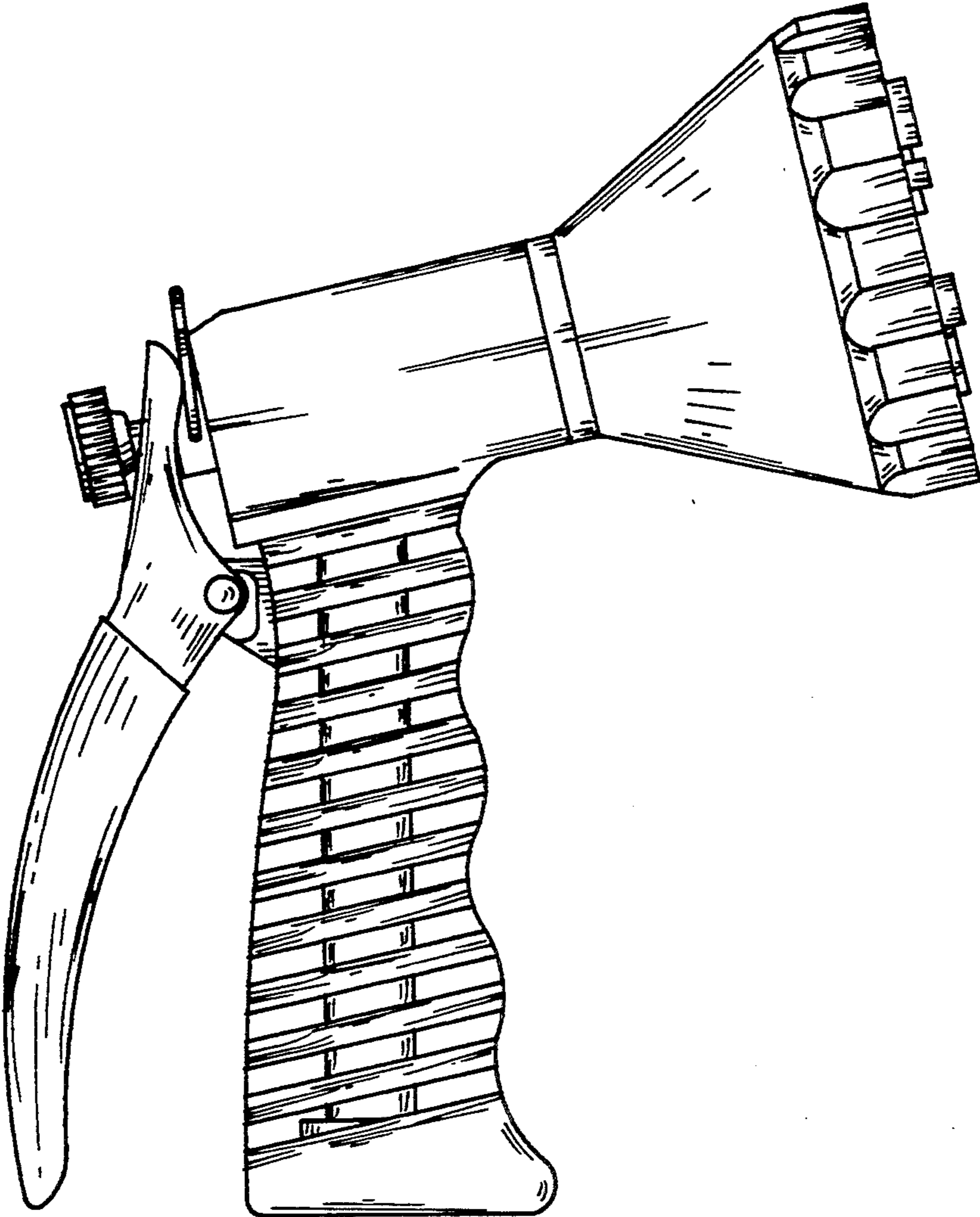

Fig.4

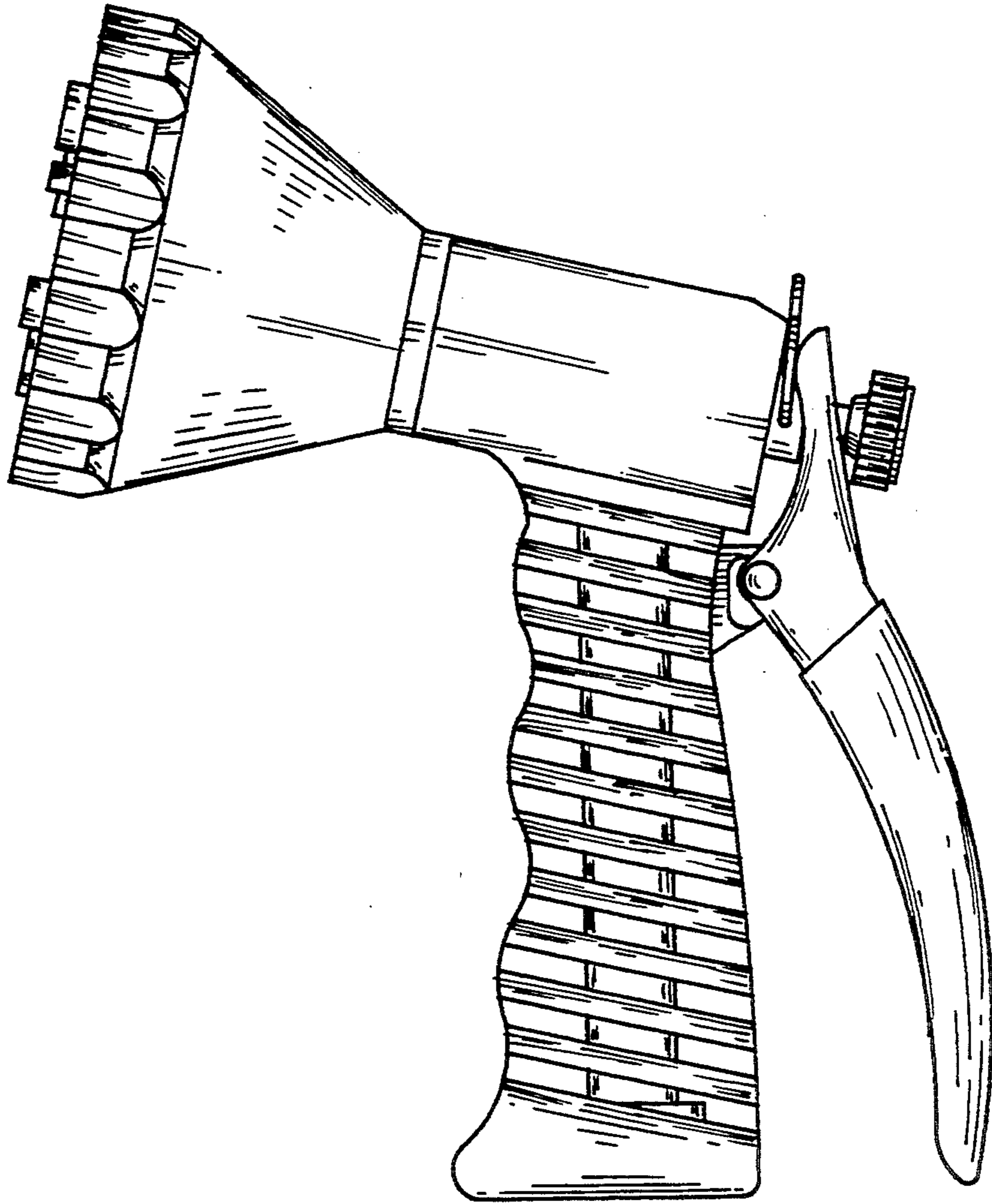

Fig.5

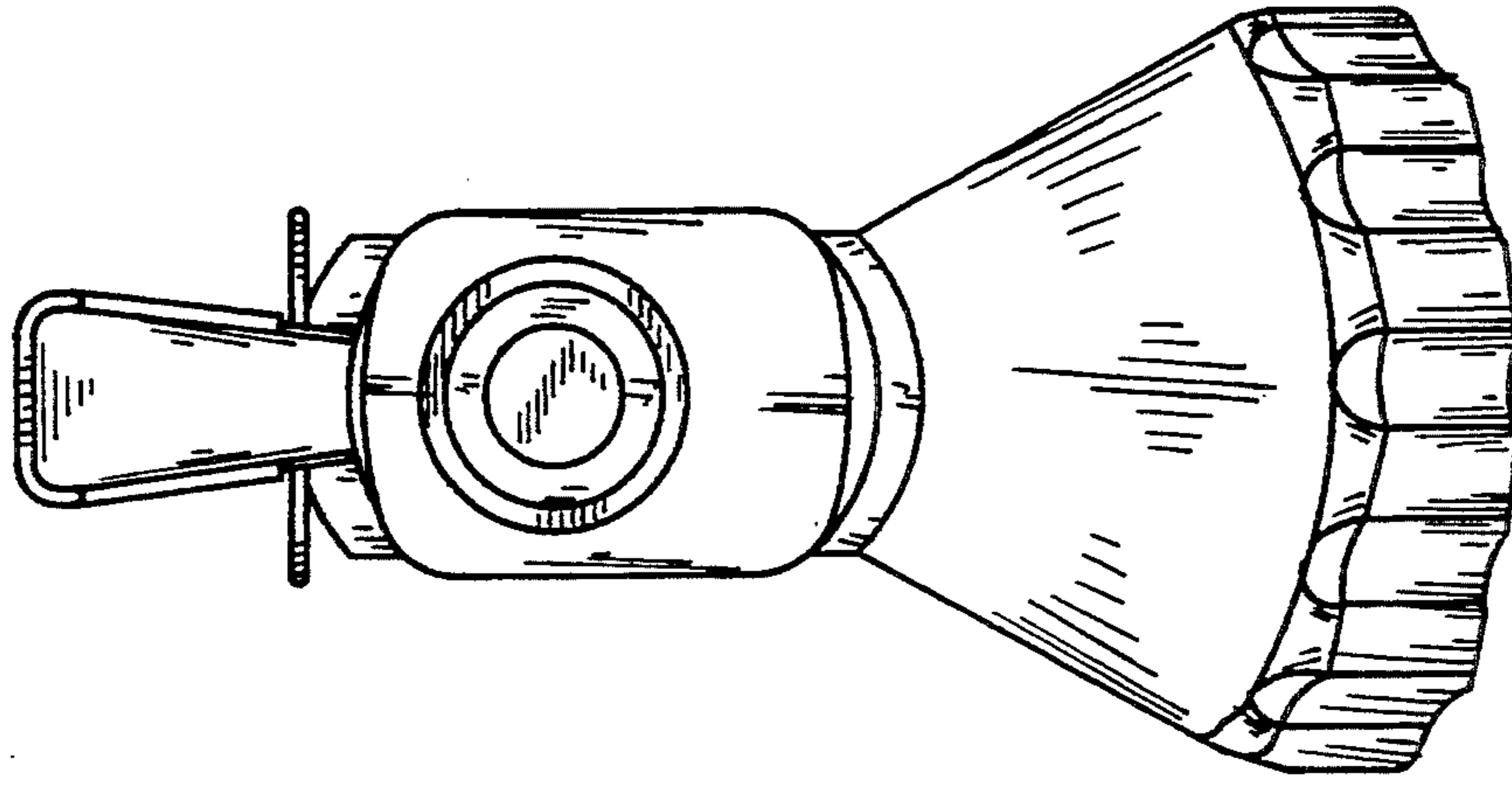

Fig.7

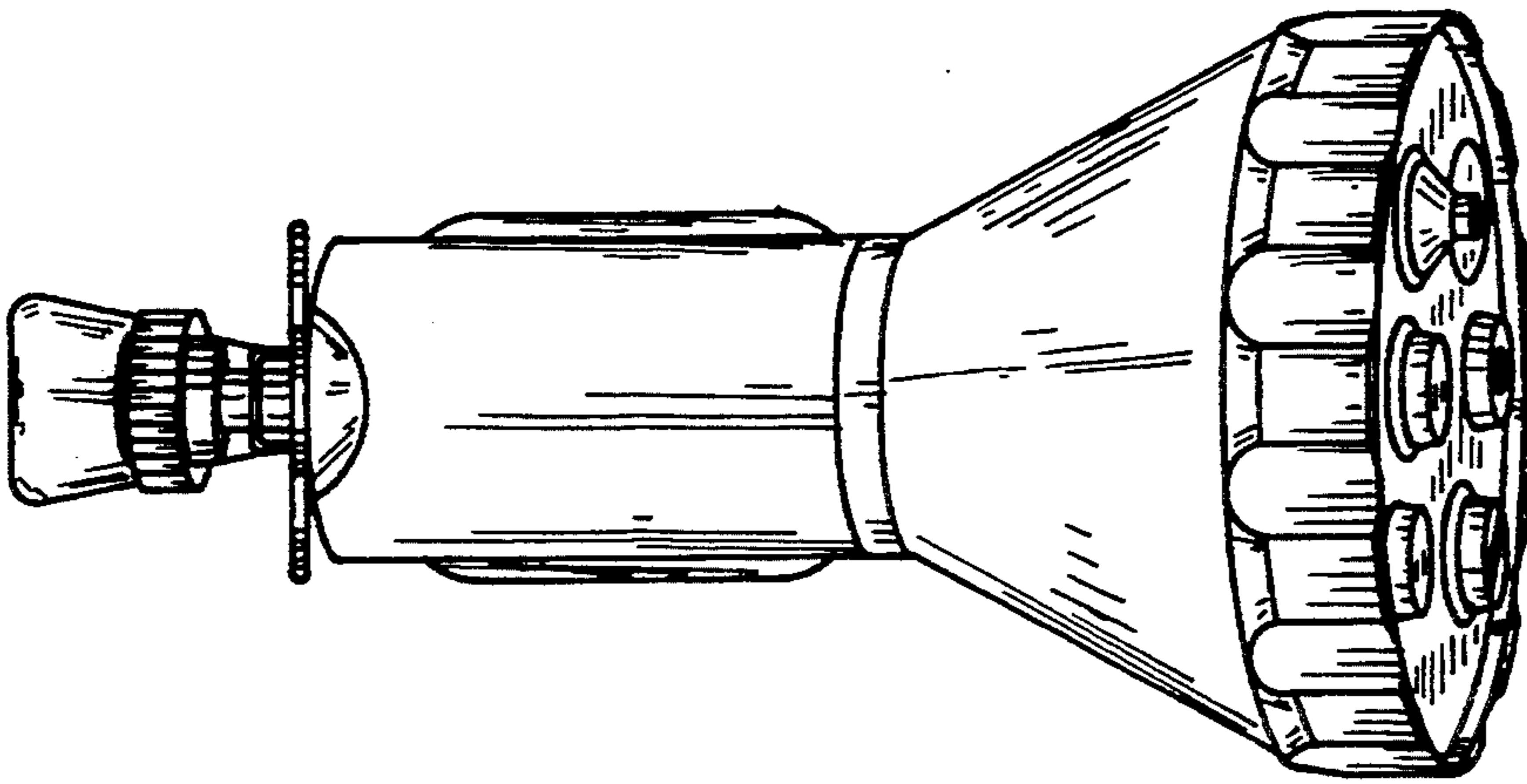

Fig.6