



US00D359033S

# United States Patent [19]

[11] Patent Number: **Des. 359,033**

Lee

[45] Date of Patent: **\*\* Jun. 6, 1995**

[54] **PORTABLE COMPUTER**

D. 346,368 4/1994 Miyashita et al. .... D14/106  
D. 347,214 5/1994 You-chi ..... D14/106  
D. 349,278 8/1994 Wetrin ..... D14/106

[75] Inventor: **Sang Hyun Lee, Kyunggi-do, Rep. of Korea**

*Primary Examiner*—Freda S. Nunn  
*Attorney, Agent, or Firm*—Hedman, Gibson & Costigan

[73] Assignee: **TriGem Computer, Inc., Kyunggi-do, Rep. of Korea**

### [57] CLAIM

[\*\*] Term: **14 Years**

The ornamental design for a portable computer, as shown and described.

[21] Appl. No.: **17,208**

[22] Filed: **Jan. 7, 1994**

### DESCRIPTION

### [30] Foreign Application Priority Data

Sep. 1, 1993 [KR] Rep. of Korea ..... 1993-17791

[52] U.S. Cl. .... **D14/106**

[58] Field of Search ..... D14/100, 101, 106, 113, D14/115, 124-127; D18/1, 2, 7, 11; 235/145 A, 145 R; 341/22, 23; 345/104, 156, 168, 173, 901-905, 87; 361/679-686; 364/708.1, 709.04, 709.12; 400/486, 489

FIG. 1 is a perspective view of the portable computer of the present invention;

FIG. 2 is a front view thereof on an enlarged scale;

FIG. 3 is a rear view thereof the broken lines being shown for illustrative purposes only and forming no part of the claimed design;

FIG. 4 is a top plan view thereof;

FIG. 5 is a bottom plan view thereof;

FIG. 6 is a left side view thereof;

FIG. 7 is a right side view thereof;

FIG. 8 is a right side view showing an opened condition thereof; and,

FIG. 9 is a top plan view showing an opened condition thereof.

### [56] References Cited

#### U.S. PATENT DOCUMENTS

D. 332,783 1/1993 Krakower et al. .... D14/106  
D. 335,870 5/1993 Yun ..... D14/106

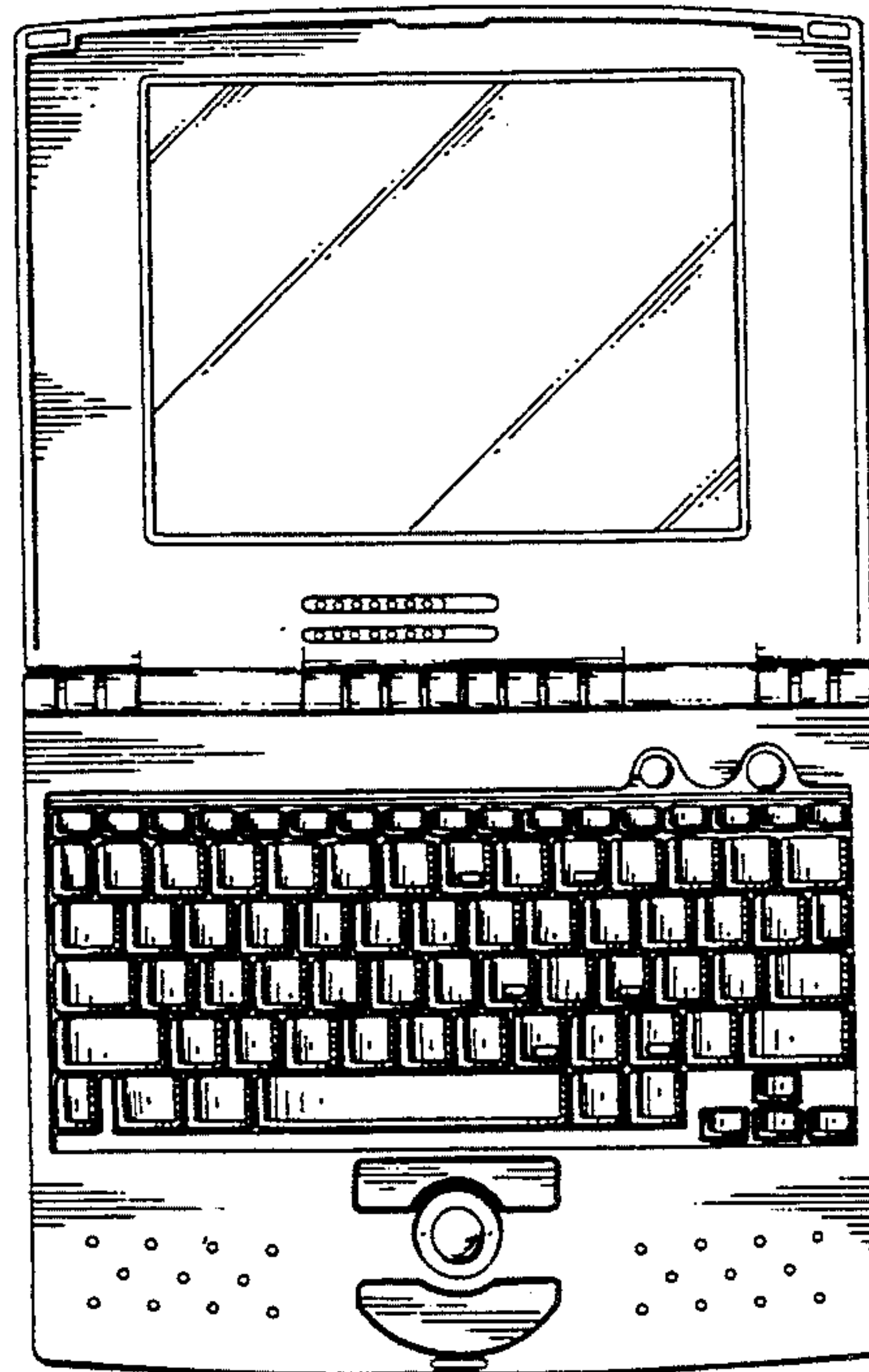
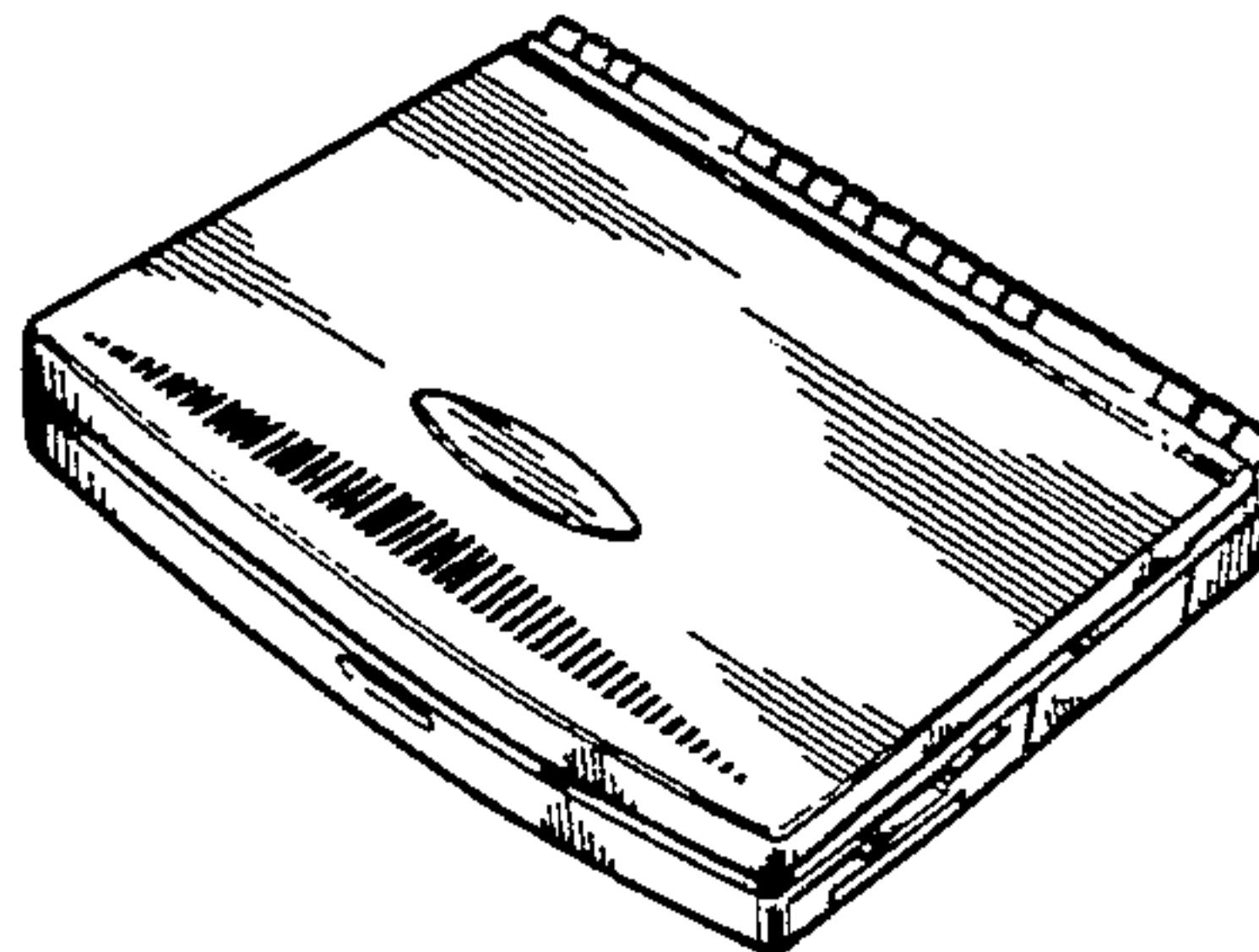

FIG.1

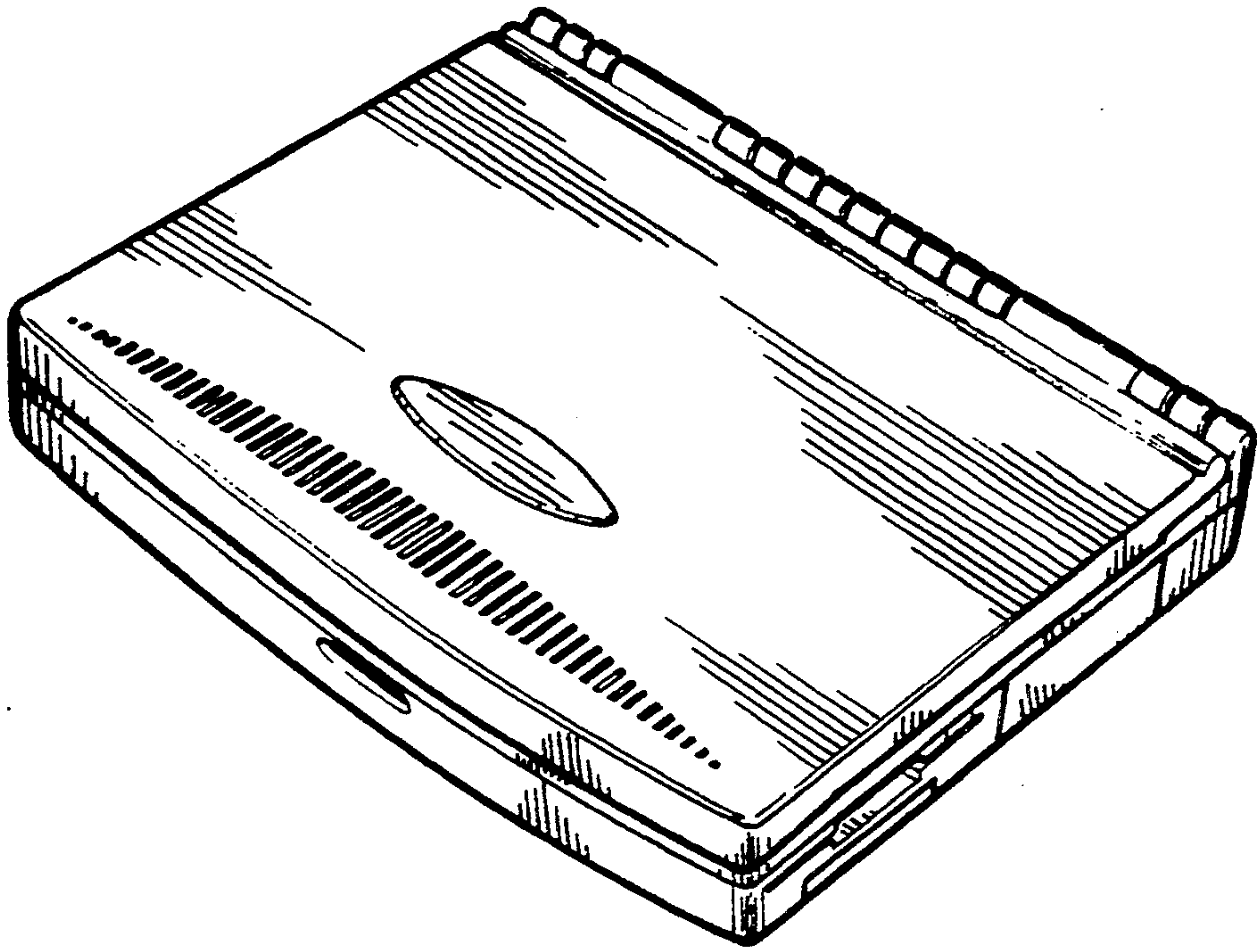

FIG. 2

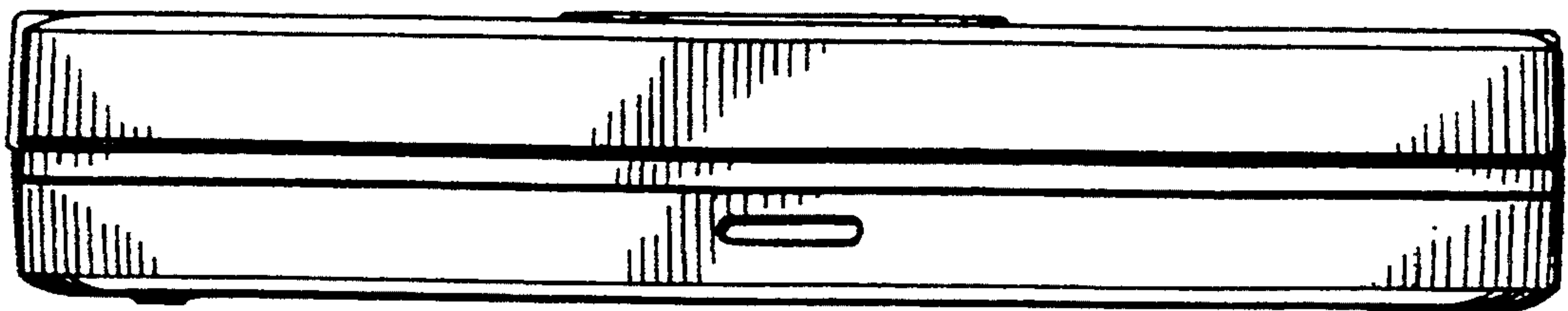

FIG. 3

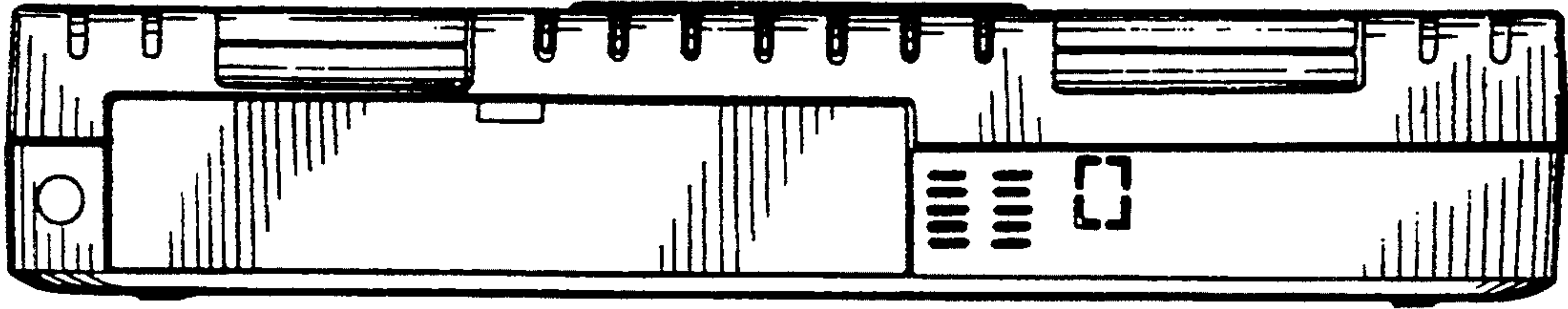

FIG. 4

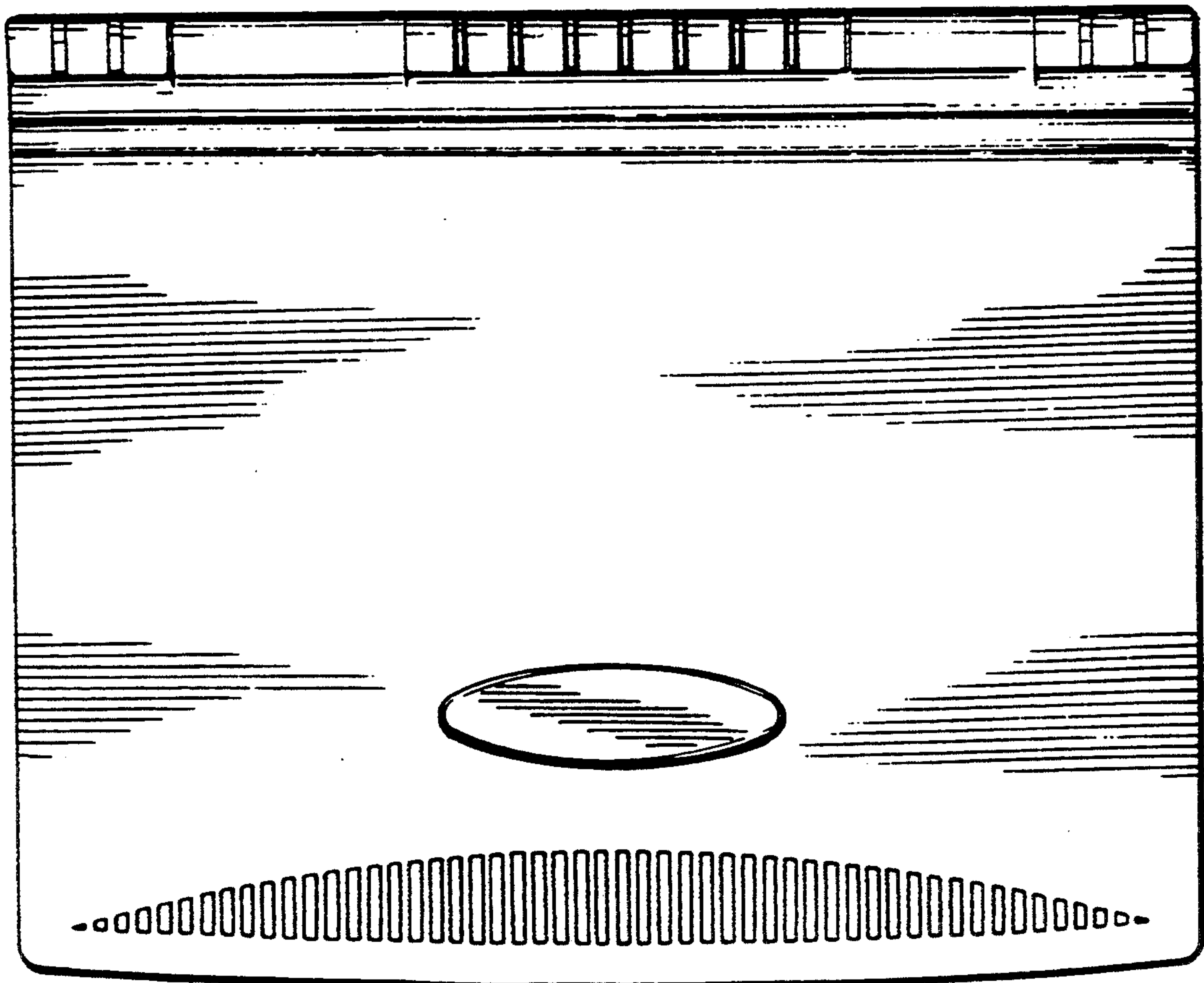



FIG. 5

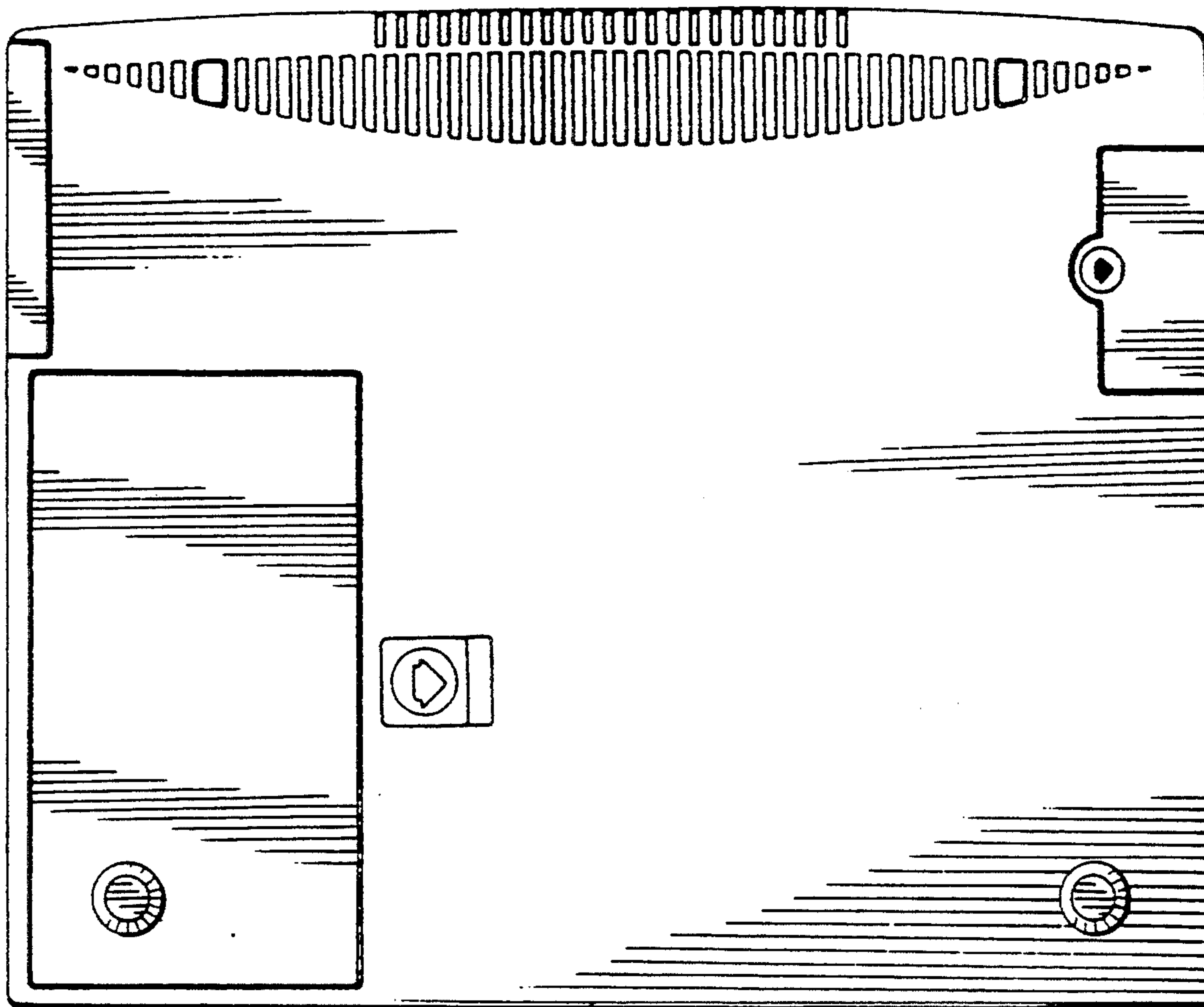

FIG. 6

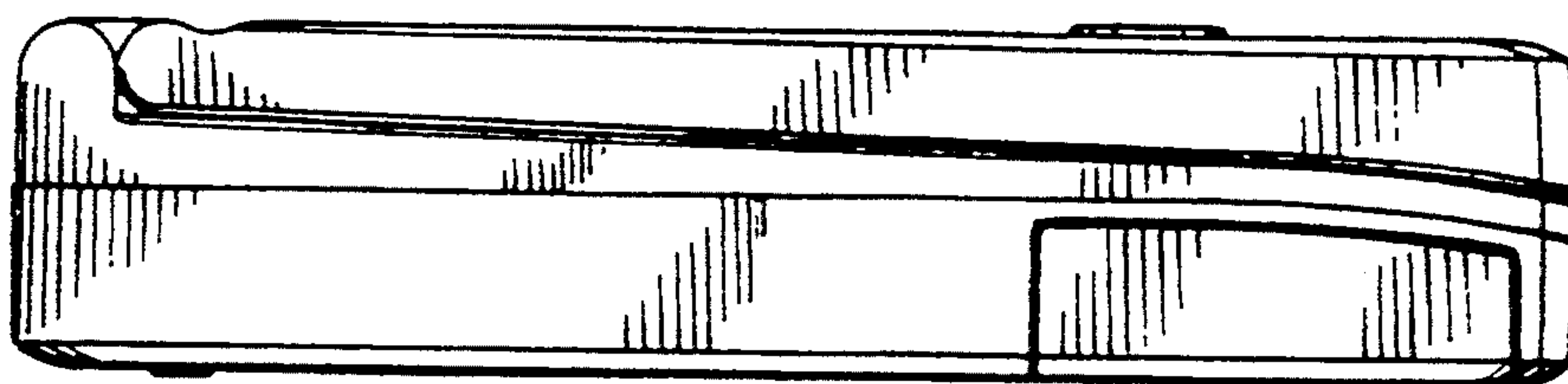

FIG. 7

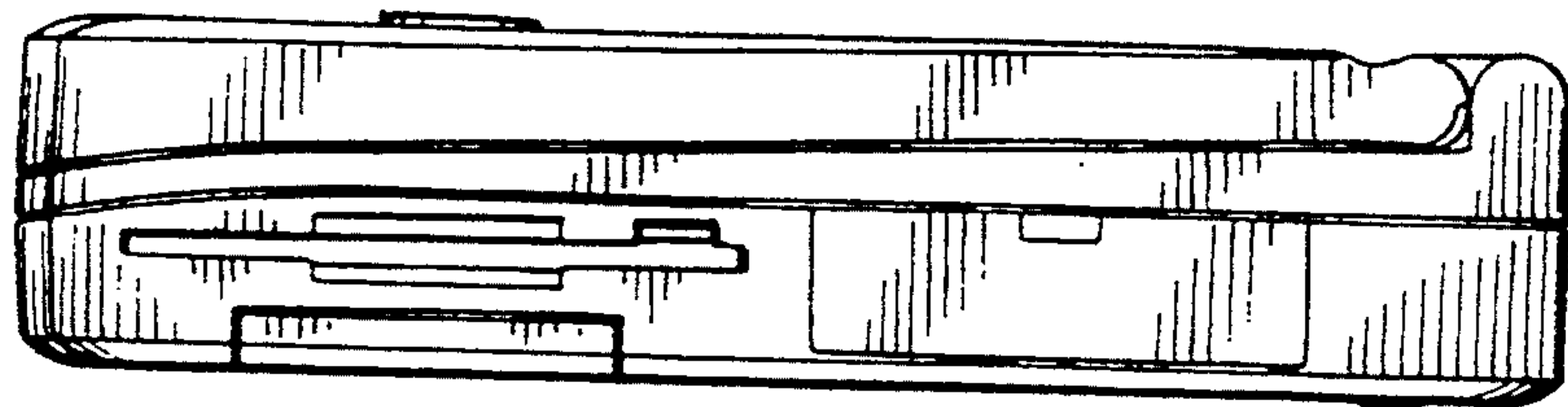

FIG. 8

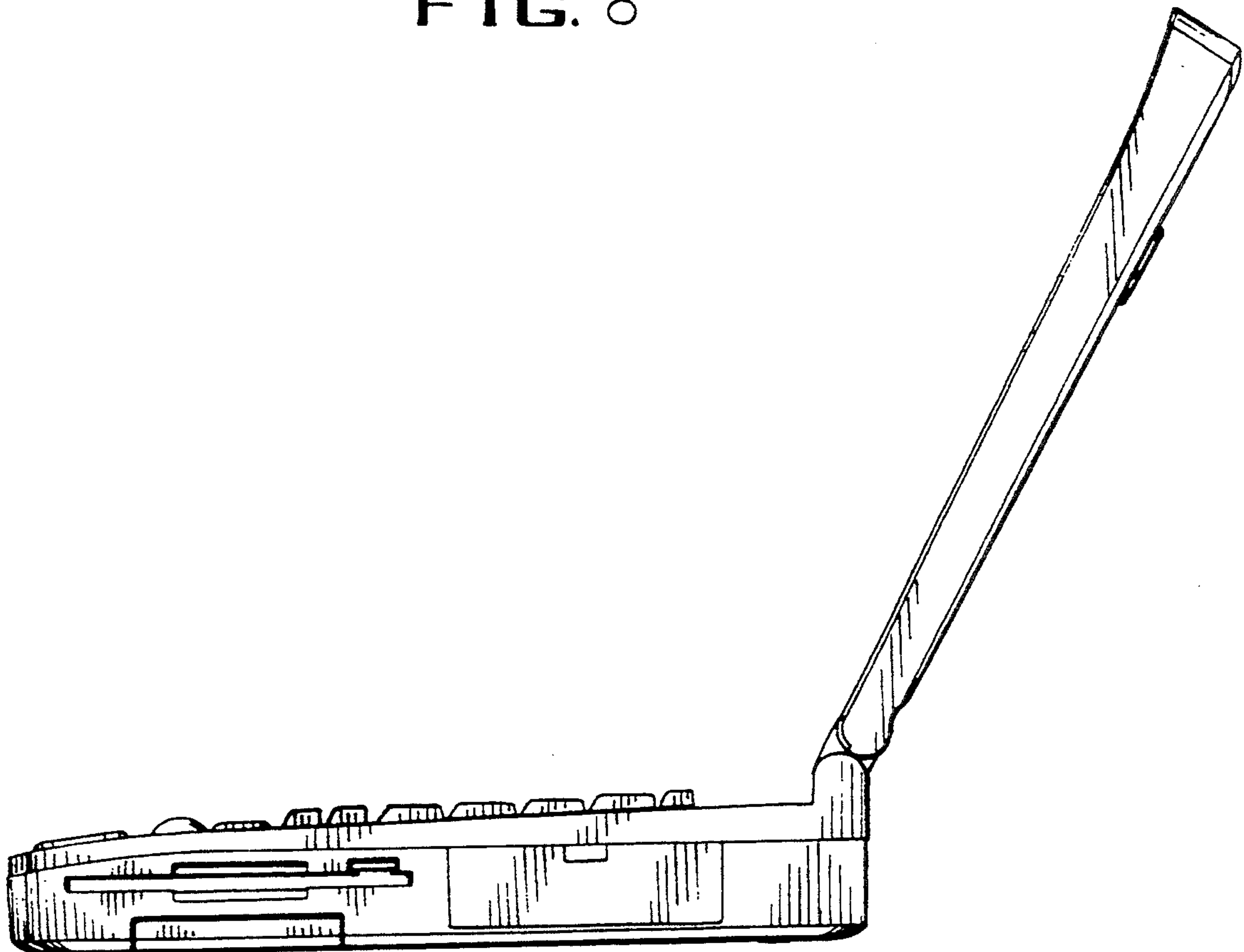

FIG. 9

