



US00D358957S

# United States Patent [19]

[11] Patent Number: **Des. 358,957**

**Propp**

[45] Date of Patent: **\*\* Jun. 6, 1995**

[54] **HEADREST EXTENDER**

5,211,696 5/1993 Lacy ..... 297/391 X  
5,216,771 6/1993 Hoff ..... 5/652 X

[76] Inventor: **Eugene Propp**, 312 Keeney,  
Evanston, Ill. 60601

### FOREIGN PATENT DOCUMENTS

490233 2/1937 United Kingdom ..... 297/397

[\*\*] Term: **14 Years**

*Primary Examiner*—Janice E. Seeger  
*Attorney, Agent, or Firm*—Thomas W. Tolpin

[21] Appl. No.: **17,016**

### [57] CLAIM

[22] Filed: **Jan. 3, 1994**

The ornamental design for a headrest extender, as shown.

[52] U.S. Cl. .... **D6/501; D6/601**

[58] Field of Search ..... **D6/491, 500-502,  
D6/596, 601, 64; 297/391, 397; 5/448, 457, 652,  
653**

### DESCRIPTION

### [56] References Cited

#### U.S. PATENT DOCUMENTS

D. 251,168 2/1979 Perkey ..... D6/601  
D. 321,562 11/1991 Ljungvall ..... D6/601 X  
744,713 11/1903 Blomquist ..... D6/596 X  
2,838,099 6/1958 Warner ..... 5/457 X  
5,015,036 5/1991 Fergie ..... D6/501 X

FIG. 1 is a perspective view of a headrest extender showing my new design;

FIG. 2 is a top view thereof;

FIG. 3 is a front view thereof;

FIG. 4 is a left side view thereof;

FIG. 5 is a right side view thereof;

FIG. 6 is a back view thereof; and,

FIG. 7 is a bottom view thereof.

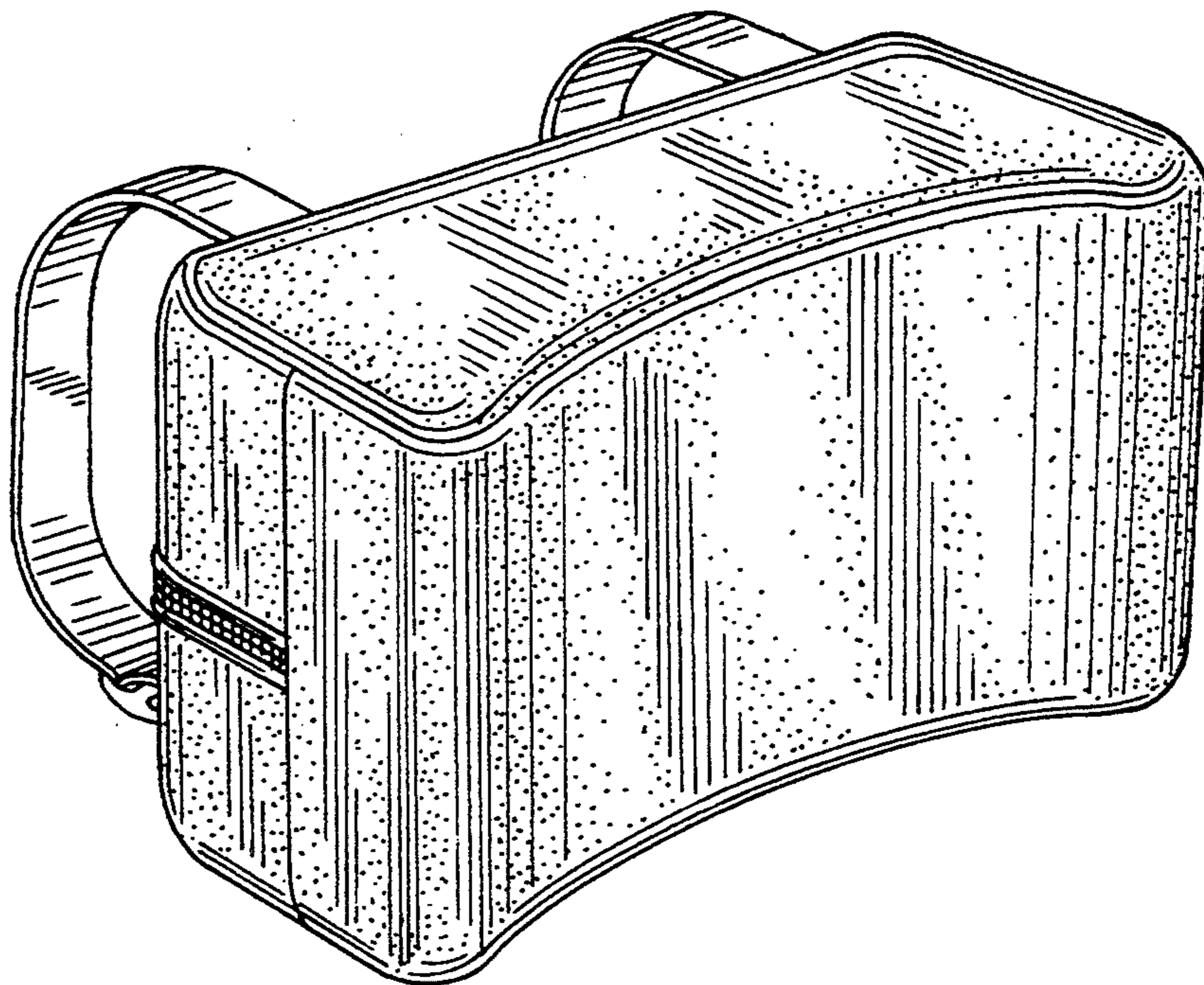

FIG. 1

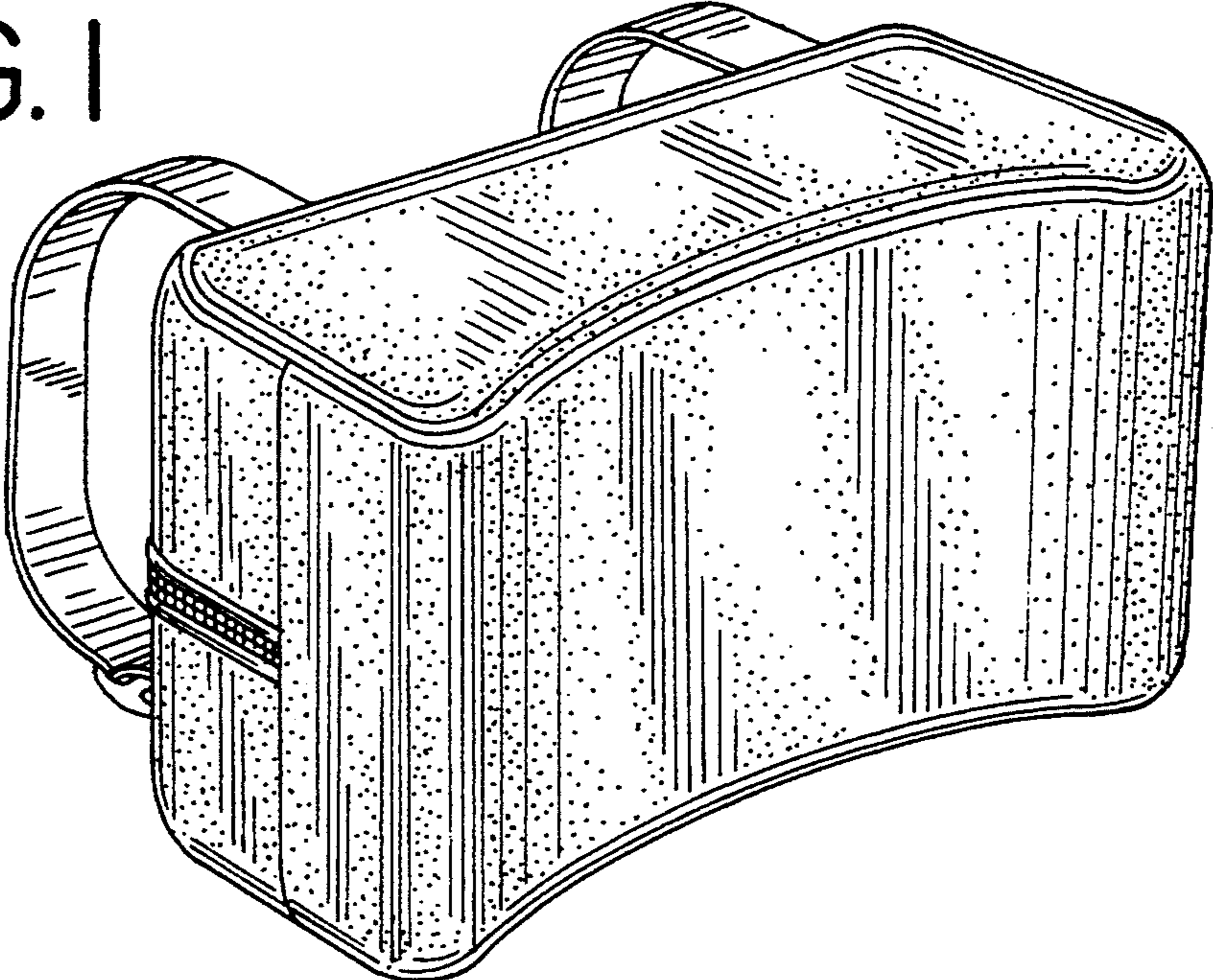

FIG. 2

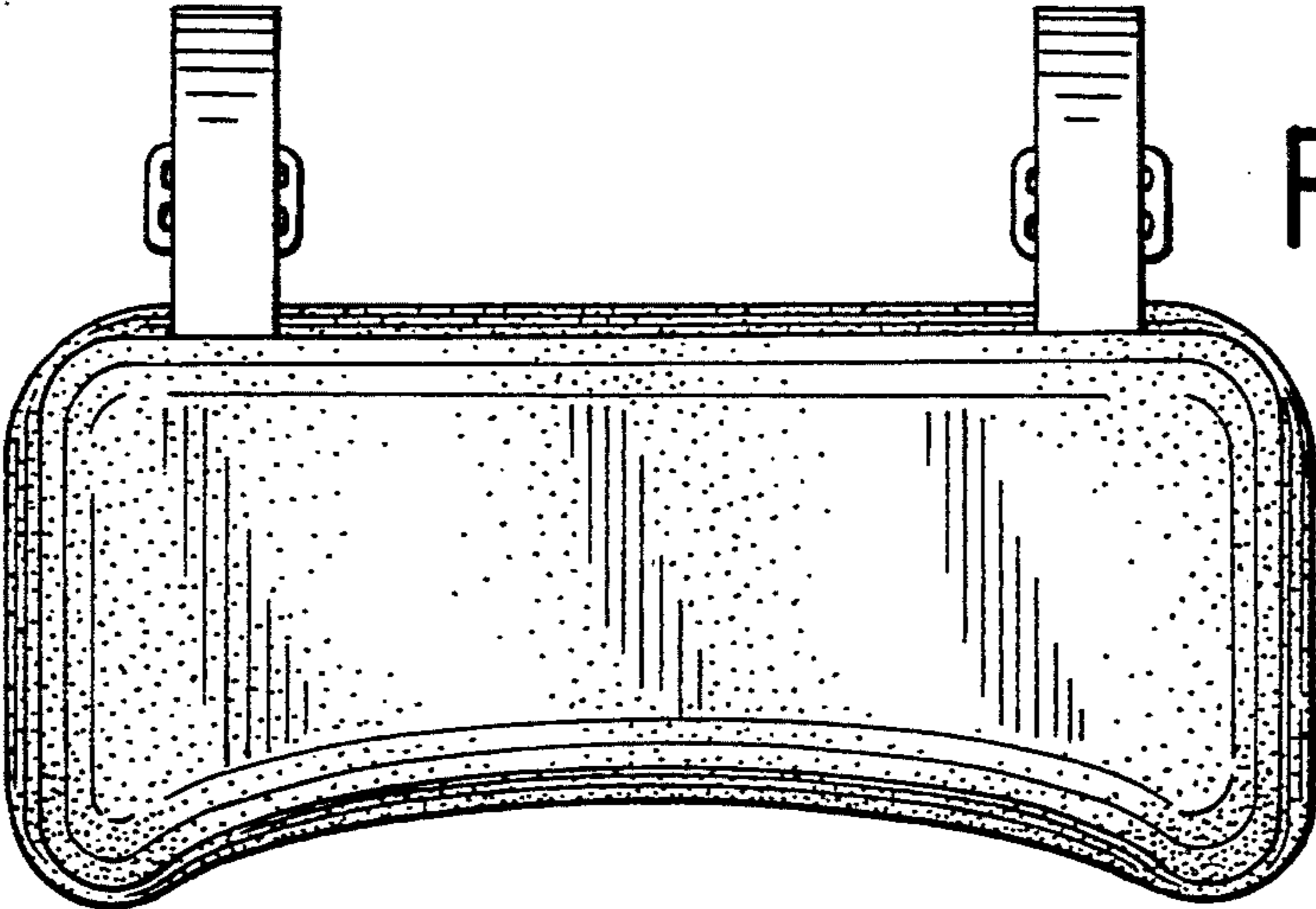

FIG. 3

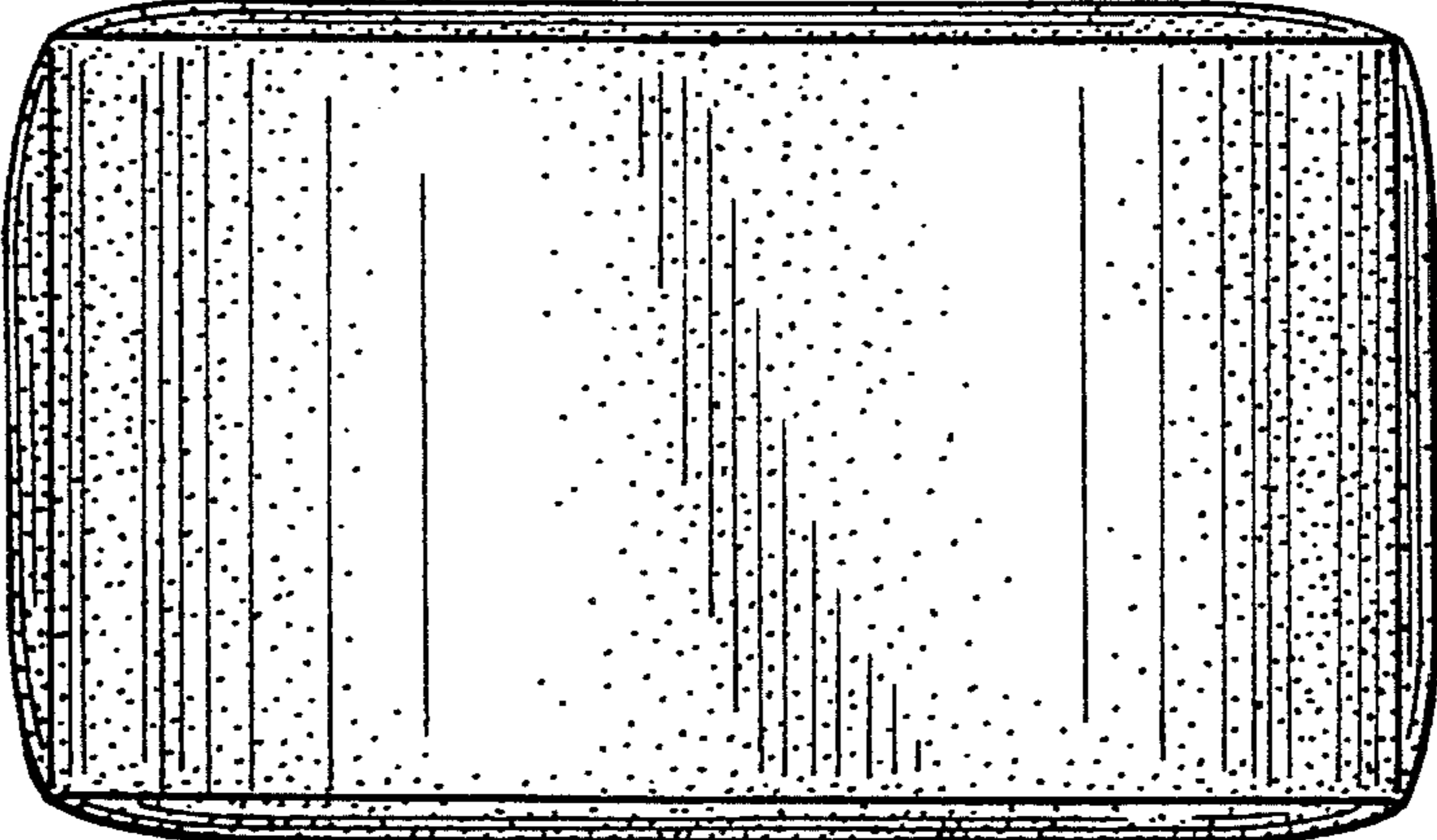



FIG. 4

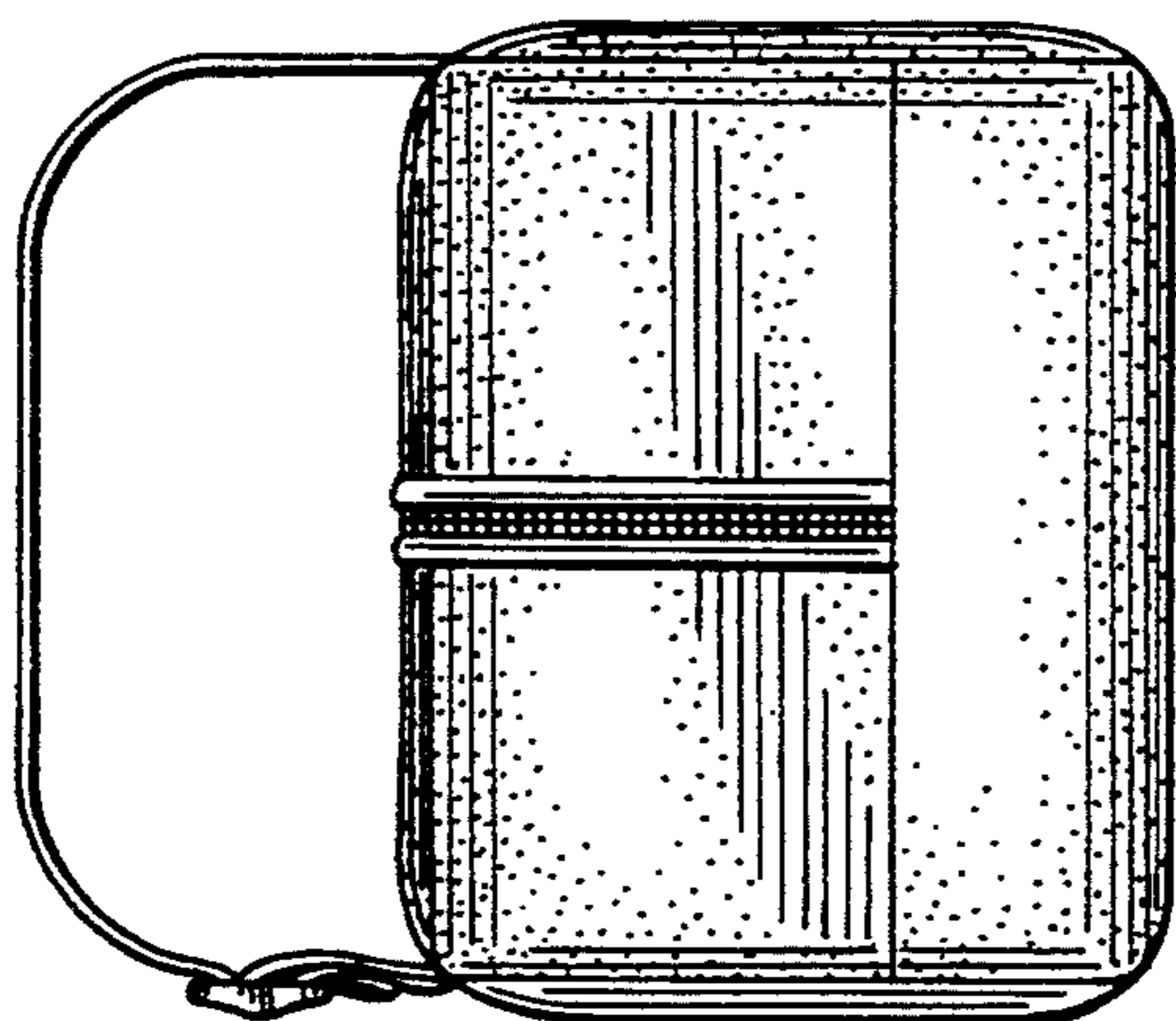

FIG. 5

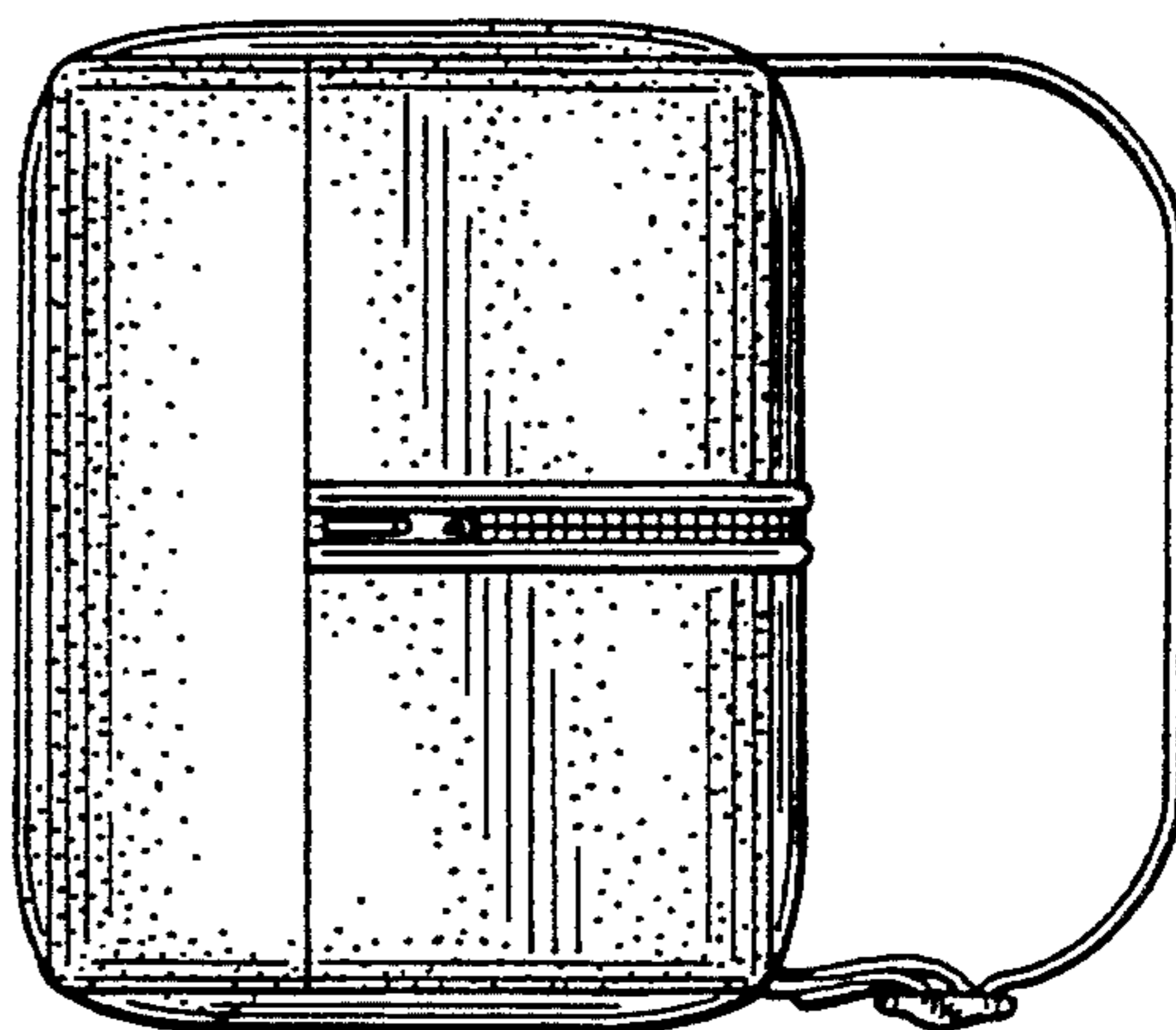

FIG. 6

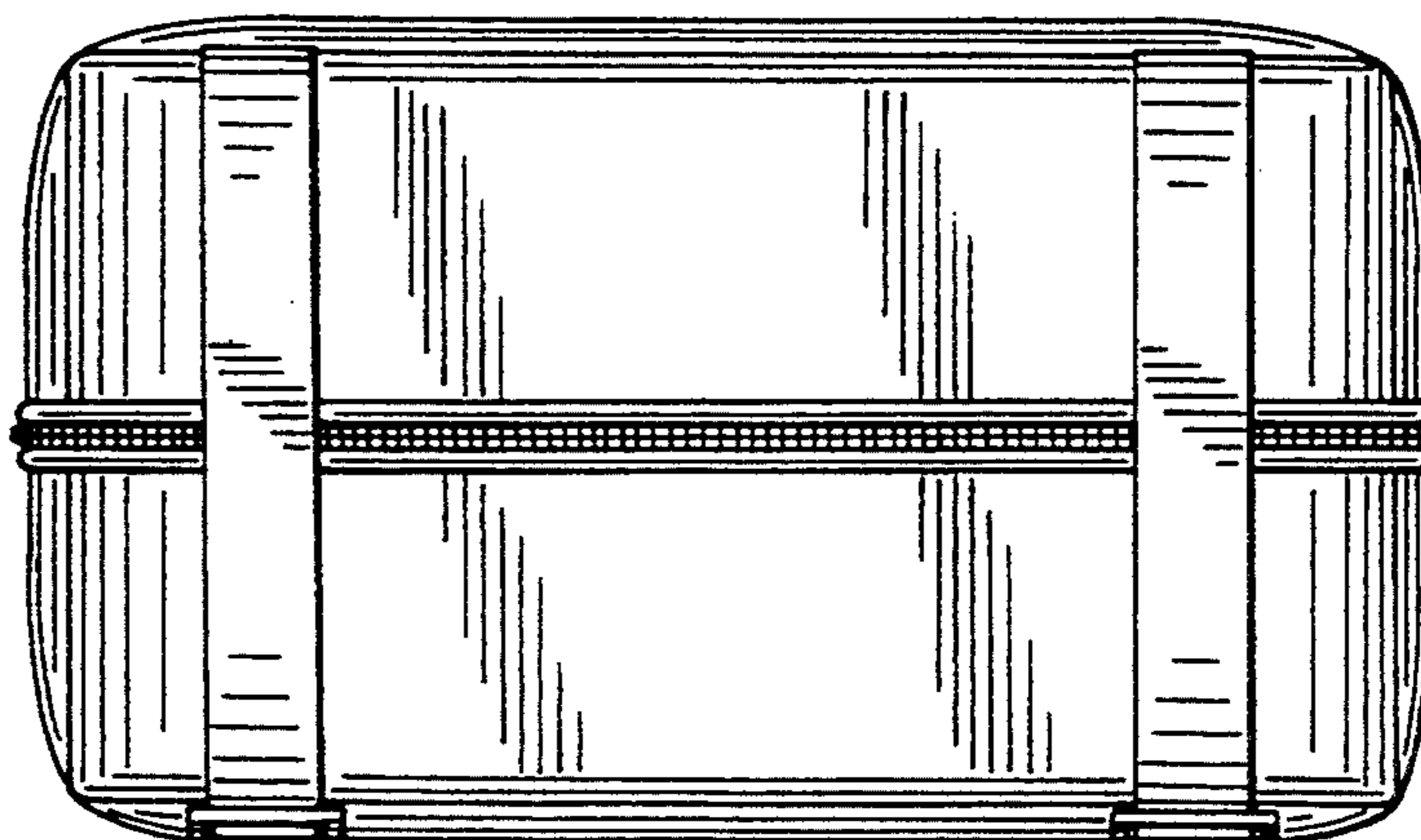

FIG. 7

