



US00D358837S

United States Patent [19]

[11] Patent Number: **Des. 358,837**

De Iuliis

[45] Date of Patent: **** May 30, 1995**

[54] COMPUTER PRINTER

[75] Inventor: **Daniele G. De Iuliis**, San Francisco, Calif.

[73] Assignee: **Apple Computer, Inc.**, Cupertino, Calif.

[**] Term: **14 Years**

[21] Appl. No.: **17,254**

[22] Filed: **Jan. 10, 1994**

[52] U.S. Cl. **D18/55**

[58] Field of Search **D18/50, 54-55; 400/613, 613.1-613.4, 690-694, 690.1-690.4**

[56] References Cited

U.S. PATENT DOCUMENTS

D. 197,539	2/1964	Knowles	D18/55
D. 325,744	4/1992	Tokuda	D18/55
D. 326,473	5/1992	Kishi et al.	D18/55
D. 336,919	6/1993	Chiba	D18/55
D. 338,229	8/1993	Tashiro et al.	D18/55
D. 348,078	6/1994	Stewart	D18/55

FOREIGN PATENT DOCUMENTS

5940890 8/1986 Japan D18/LD18 55

OTHER PUBLICATIONS

Hewlett Packard Laser Jet 4M Printer brochure; Apr. 15, 1993 D.C. Trade Show.

Primary Examiner—Cathy Anne MacCormac
Attorney, Agent, or Firm—Nancy R. Simon

[57] CLAIM

The ornamental design for a computer printer, as shown.

DESCRIPTION

FIG. 1 is a top, front, right perspective view of a computer printer, showing my new design;
 FIG. 2 is a top, back, left perspective view thereof;
 FIG. 3 is a top view thereof;
 FIG. 4 is a front view thereof;
 FIG. 5 is a bottom view thereof;
 FIG. 6 is a back view thereof;
 FIG. 7 is a left side view thereof; and,
 FIG. 8 is a right side view thereof.

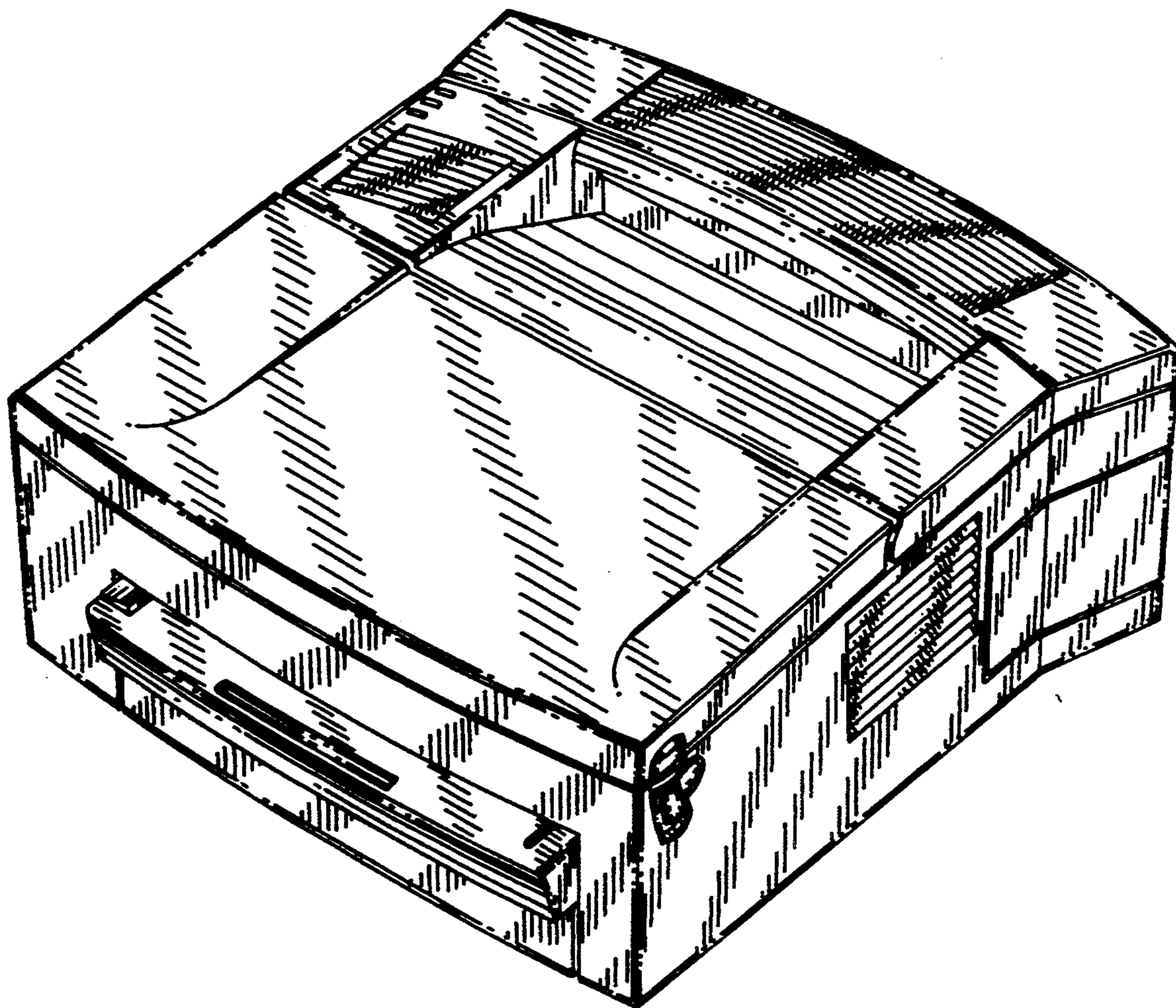

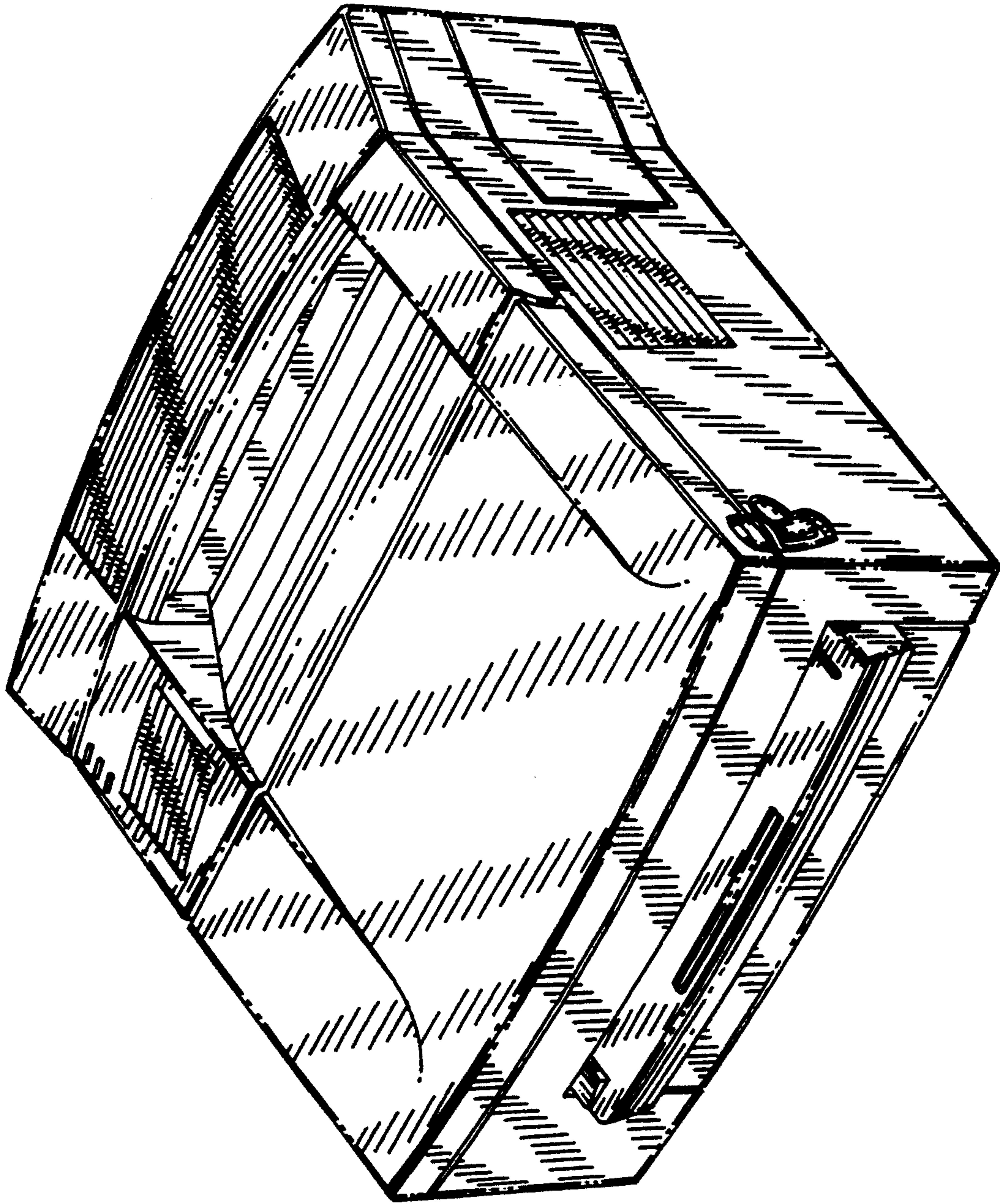

FIG. 1

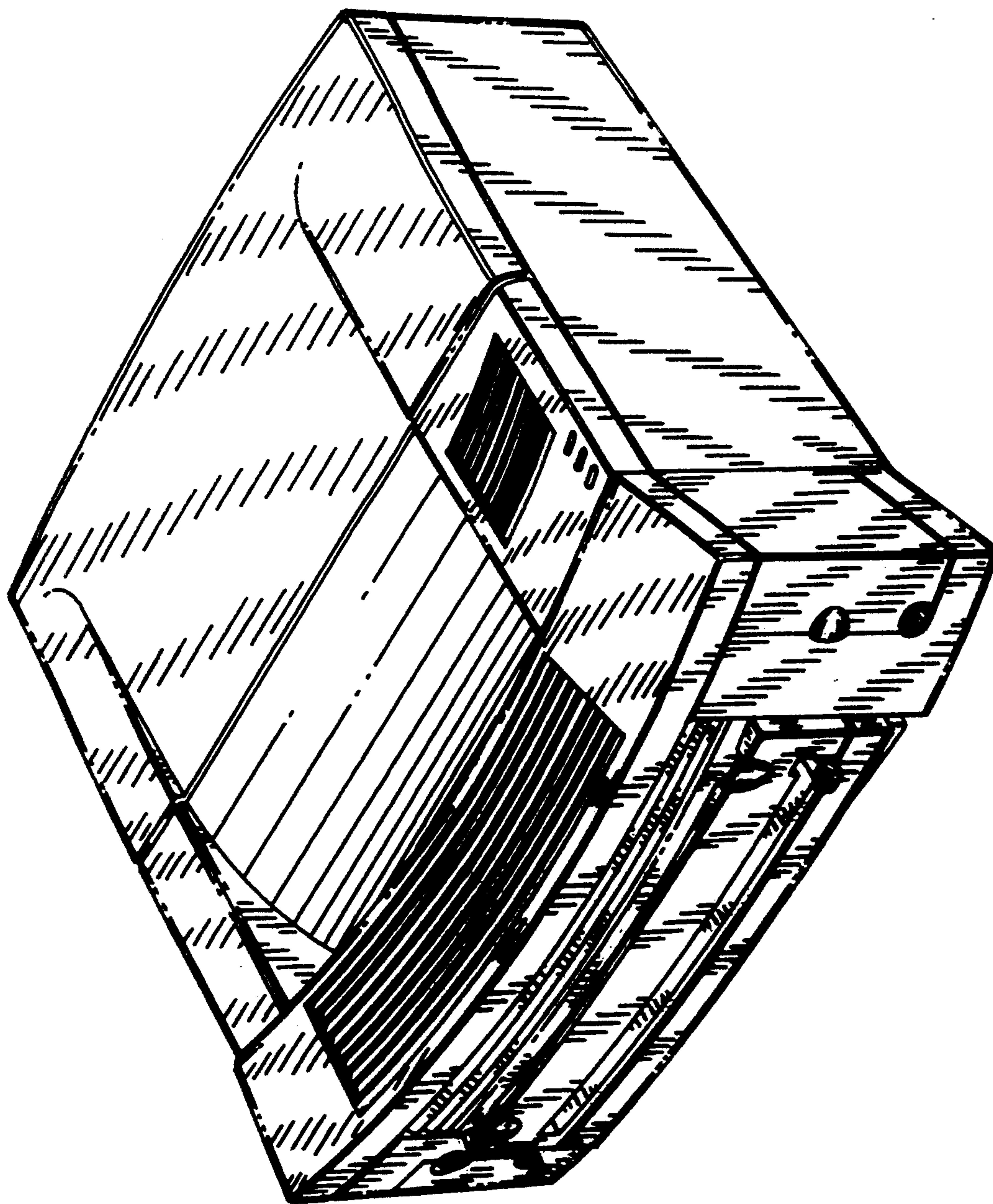

FIG. 2

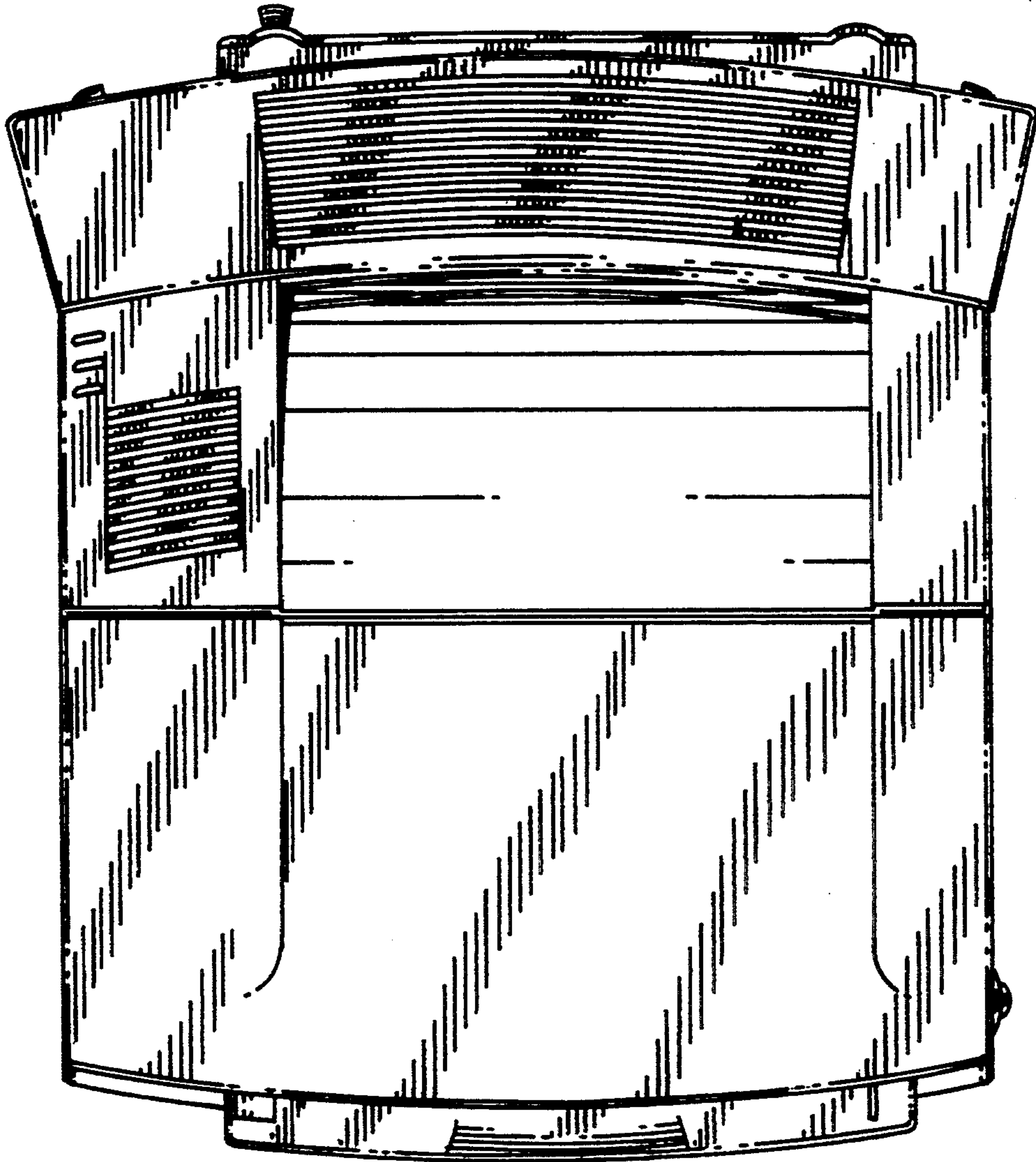

FIG 3

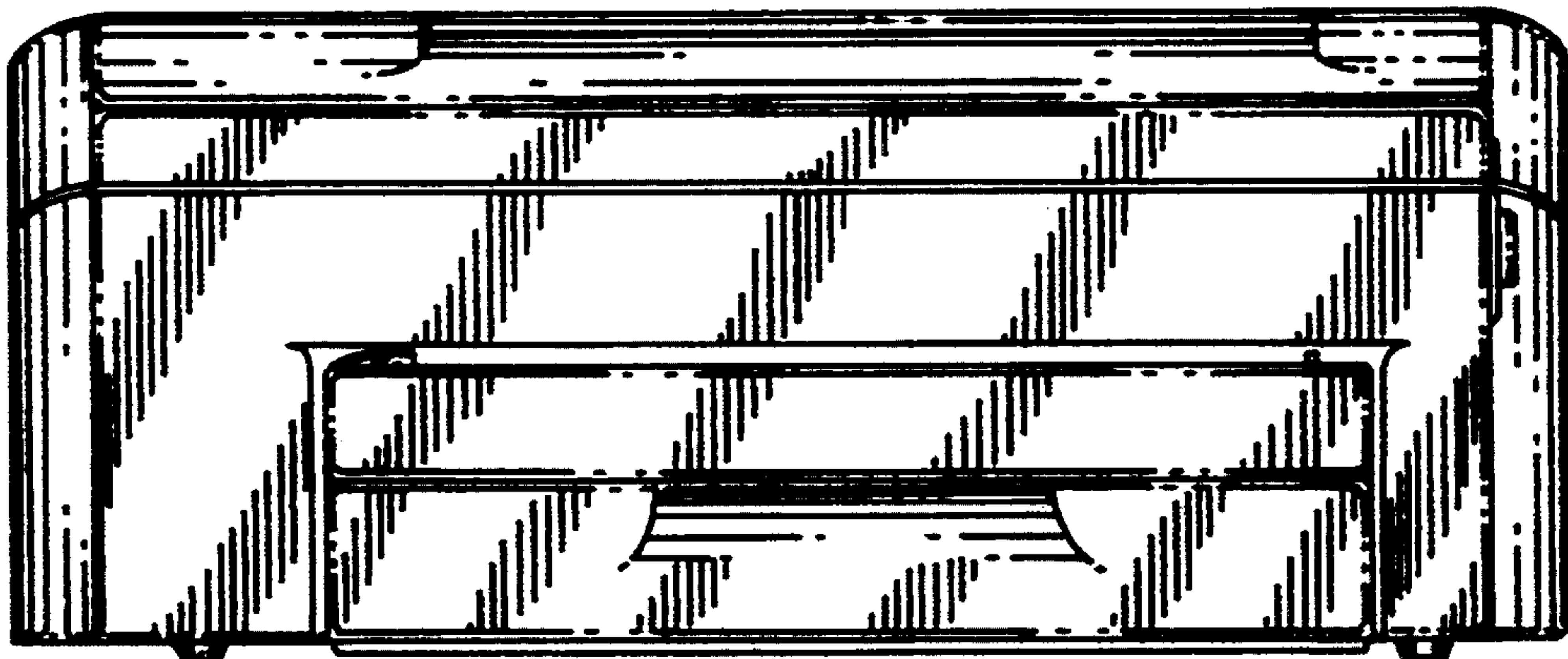

FIG 4

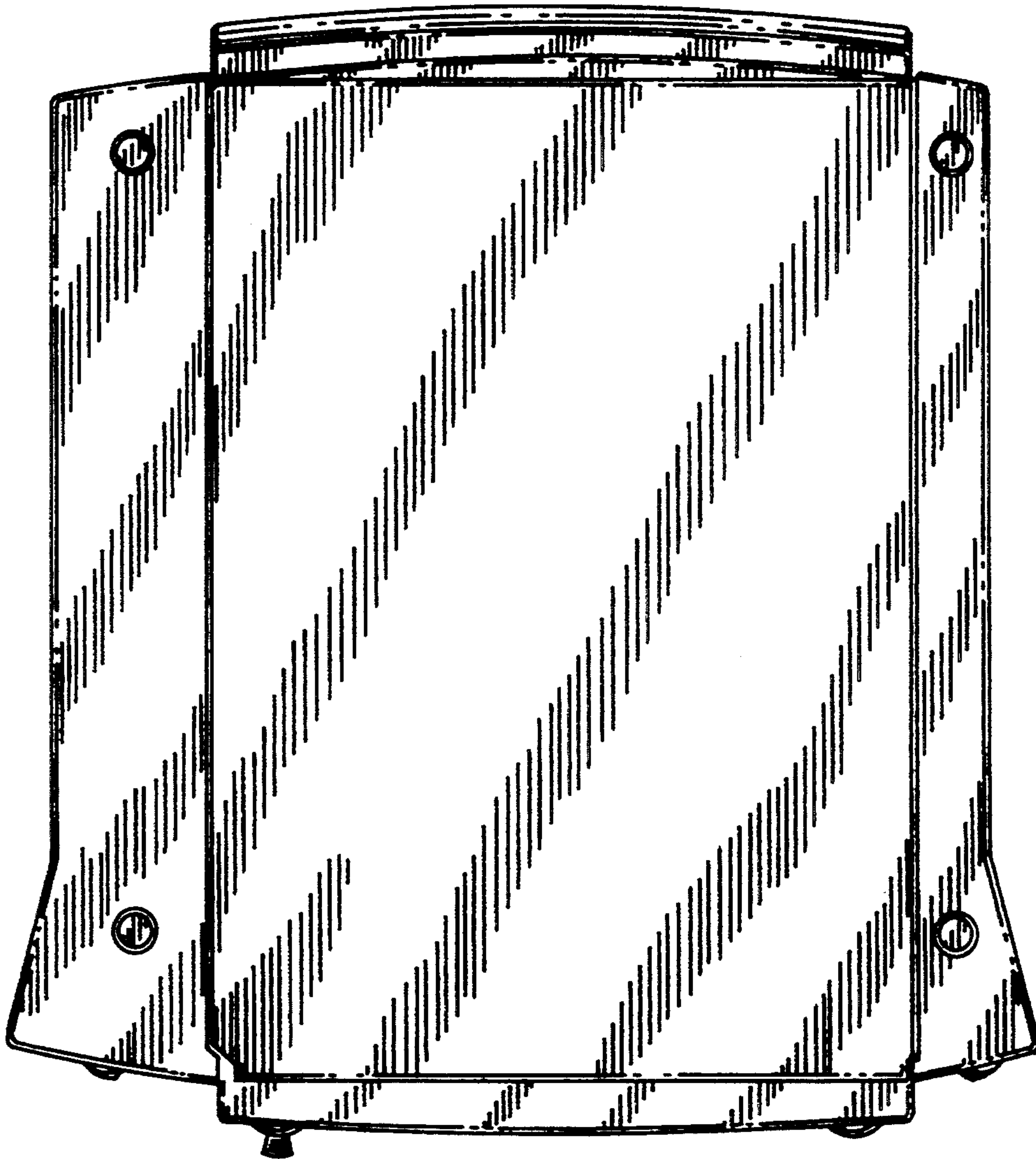

FIG 5

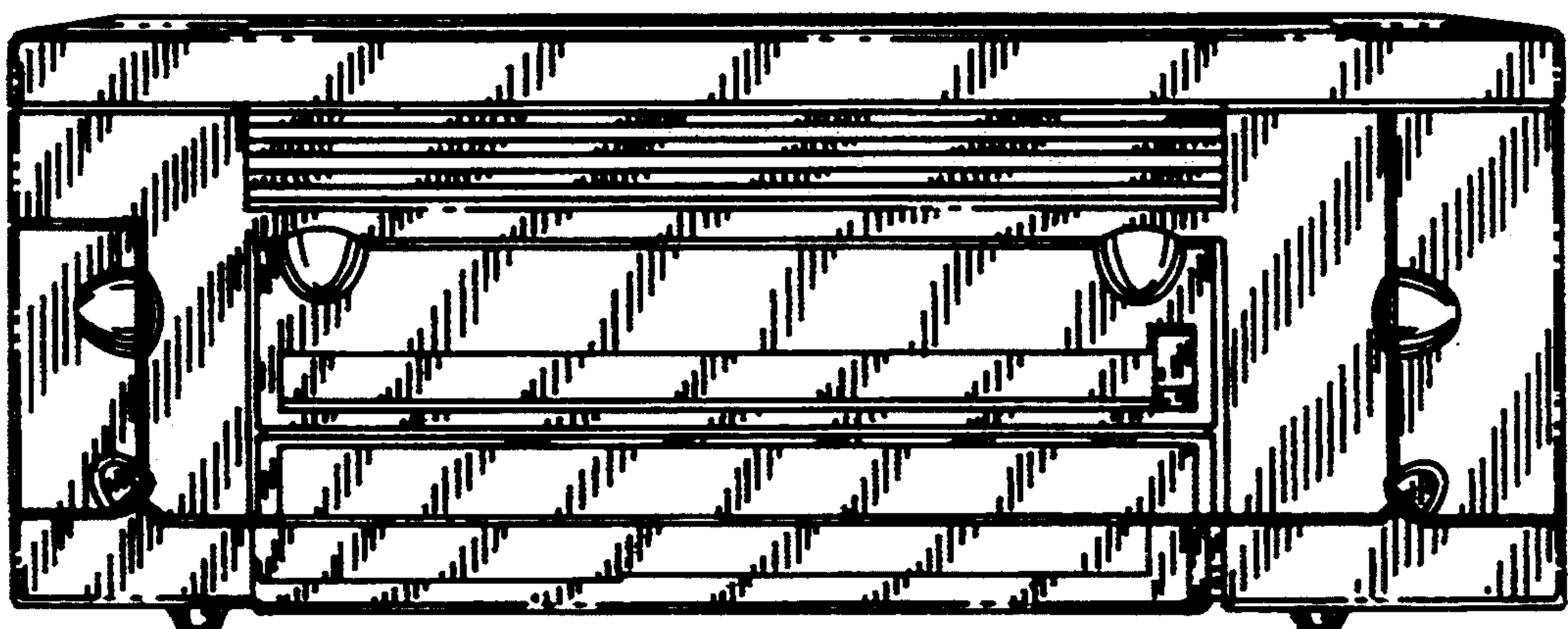

FIG 6

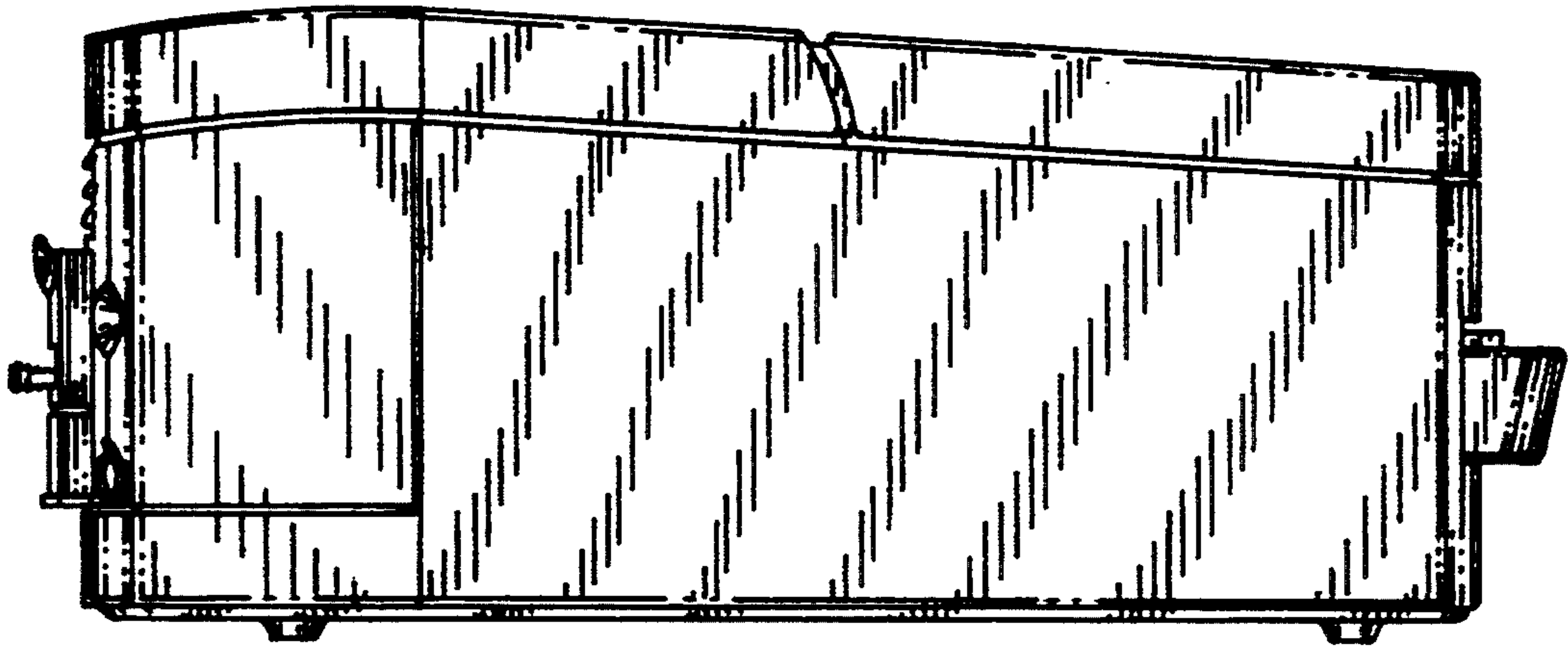

FIG 7

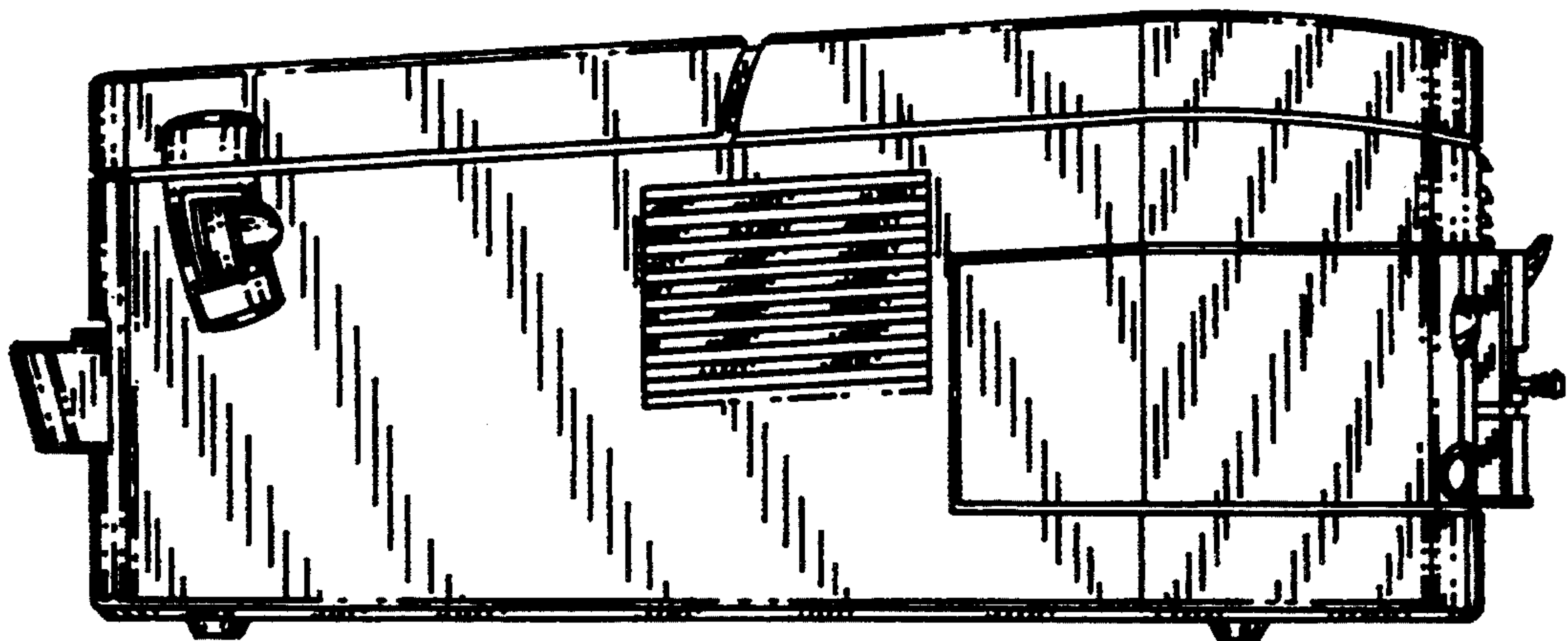

FIG 8