



US00D358827S

United States Patent [19] Fung

[11] Patent Number: **Des. 358,827**

[45] Date of Patent: **** May 30, 1995**

[54] VACUUM SEALING MACHINE

[56] References Cited

U.S. PATENT DOCUMENTS

- D. 306,303 2/1990 Takeda D15/146 X
- D. 342,532 12/1993 Deni D15/146
- 5,232,538 8/1993 Liu D15/146 X

Primary Examiner—Antoine Duval Davis
Attorney, Agent, or Firm—Samuels, Gauthier & Stevens

[76] Inventor: **Shiu-Po Fung**, 12/F Flat B,C & D
City Industrial Complex 116-122
Kwok Shui Road, Kwai Chung
N.T., Hong Kong

[**] Term: **14 Years**

[57] CLAIM

The ornamental design for a vacuum sealing machine, as shown and described.

[21] Appl. No.: **24,513**

DESCRIPTION

FIG. 1 is the front elevational view showing my new design;
FIG. 2 is the rear elevational view thereof;
FIG. 3 is the left side view thereof;
FIG. 4 is the right side view thereof;
FIG. 5 is the top plan view thereof; and,
FIG. 6 is the bottom view thereof.

[22] Filed: **Jun. 15, 1994**
[52] U.S. Cl. **D15/146**
[58] Field of Search D15/146; 53/432-434,
53/510-512, DIG. 2; 156/497, 583.1-583.91

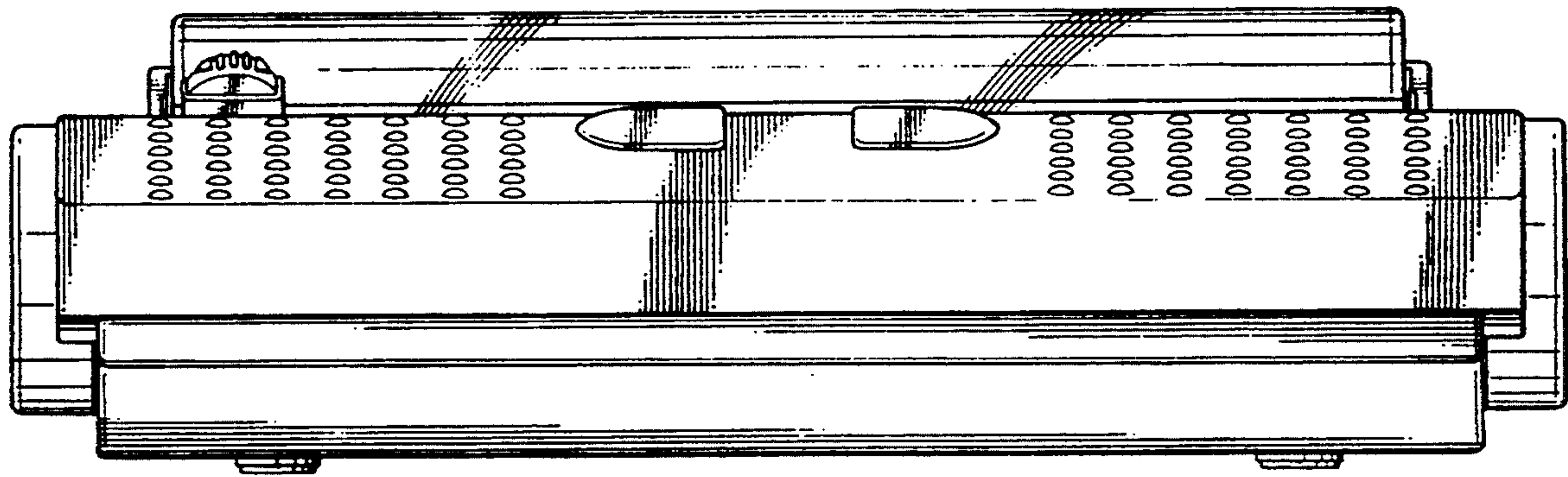

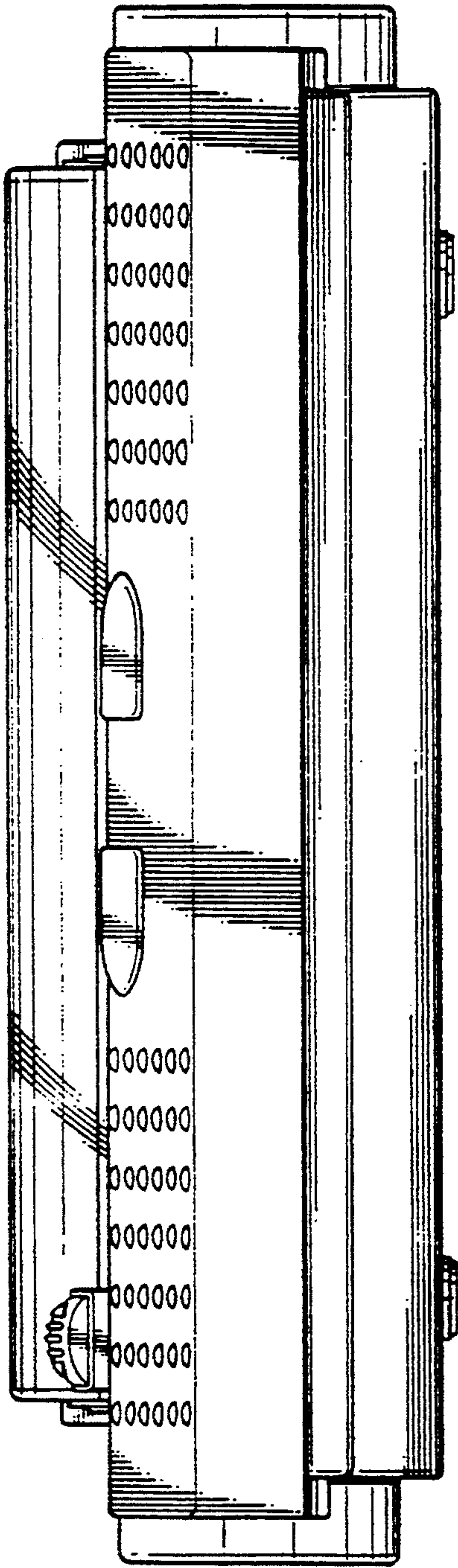

FIG. 1

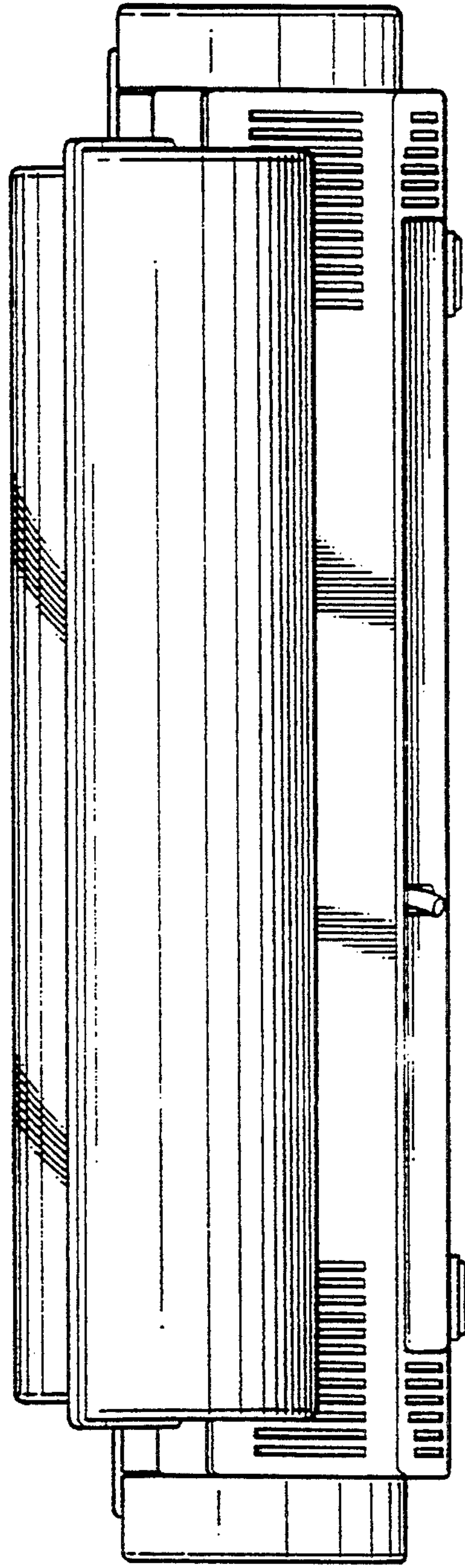

FIG. 2

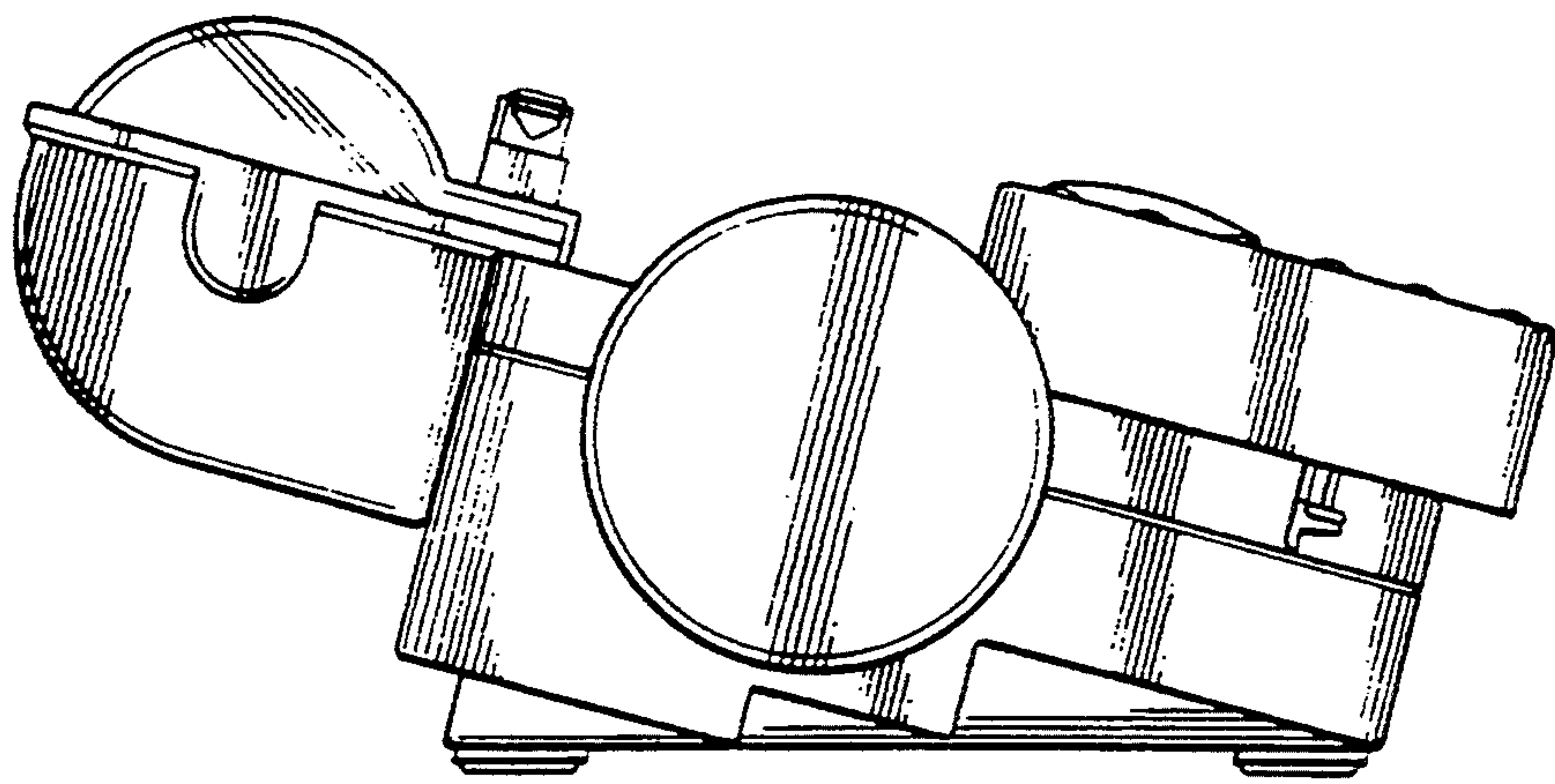

FIG. 3

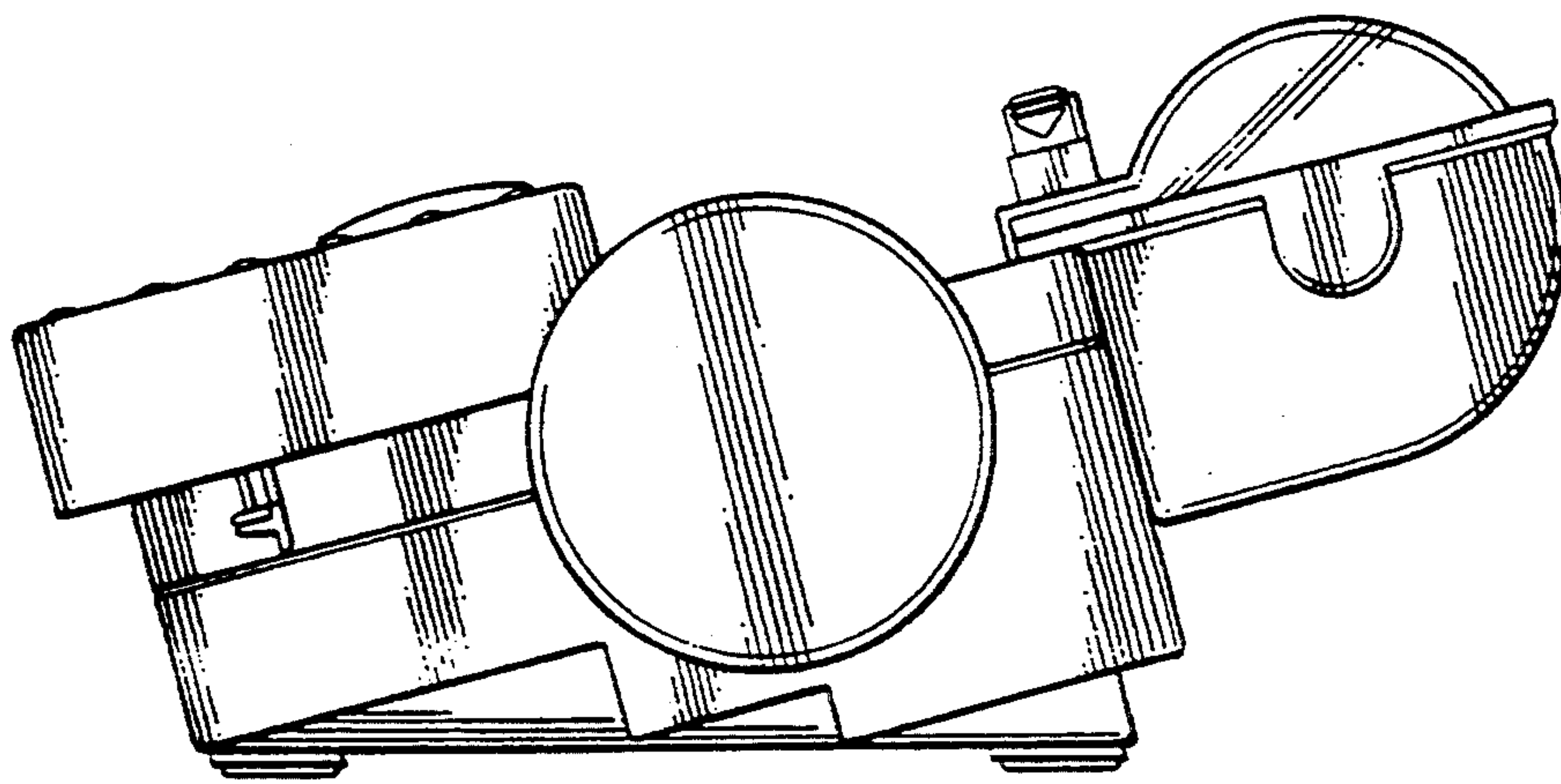

FIG. 4

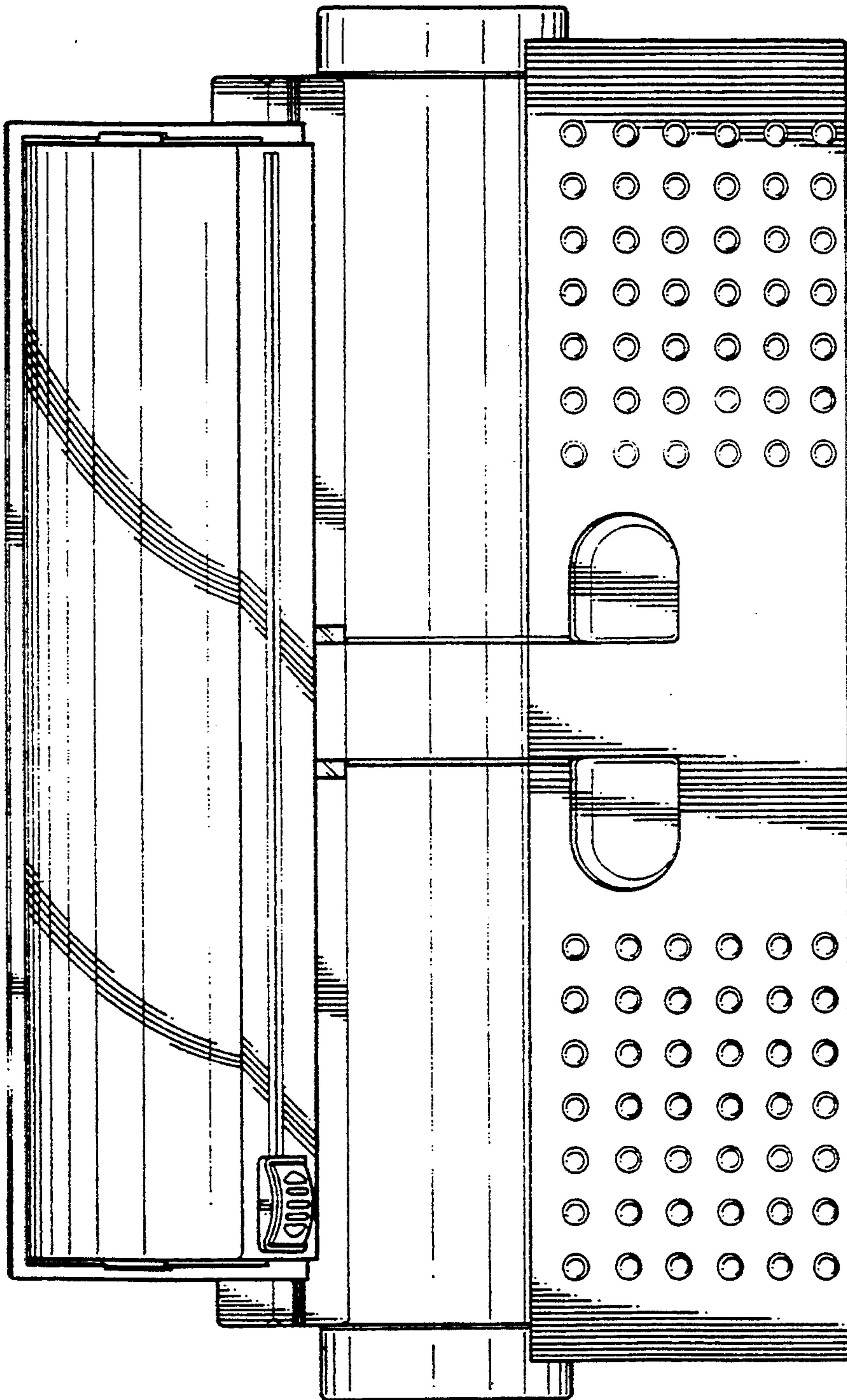

FIG. 5

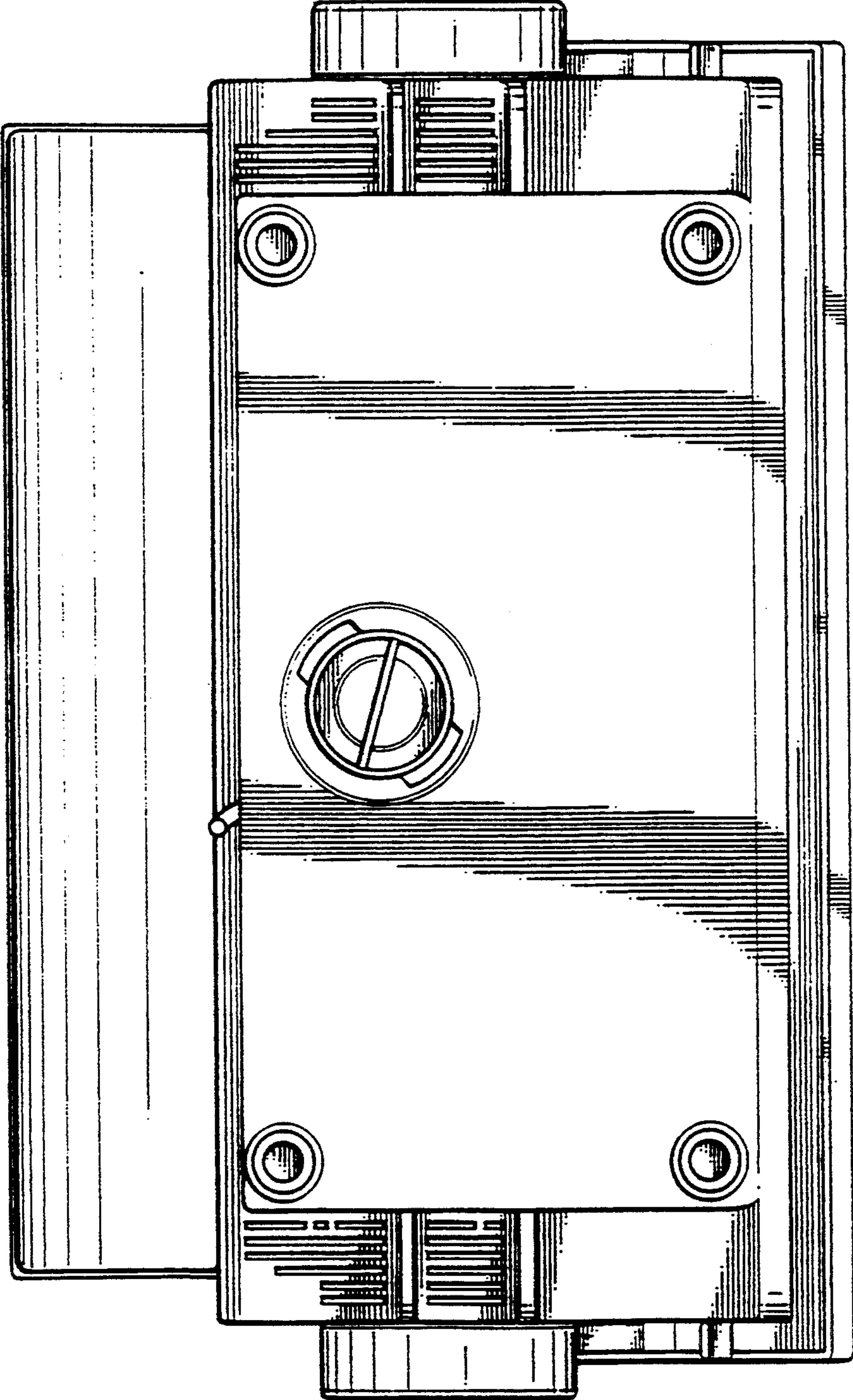

FIG. 6