



US00D358762S

United States Patent [19]

[11] Patent Number: **Des. 358,762**

Walchek, Jr. et al.

[45] Date of Patent: **** May 30, 1995**

[54] **TRIFOLD PHARMACEUTICAL TABLET DISPENSER**

5,109,984 5/1992 Romick 206/539 X

[75] Inventors: **William Walchek, Jr., Wayne; Paul R. Finkelston**, Philadelphia, both of Pa.

FOREIGN PATENT DOCUMENTS

859539 12/1970 Canada .
2917108 11/1980 Germany .
537319 7/1973 Switzerland .

[73] Assignee: **American Home Products Corporation**, Madison, N.J.

Primary Examiner—Prabhakar G. Deshmukh
Attorney, Agent, or Firm—Robert F. Boswell, Jr.

[*] Notice: The portion of the term of this patent subsequent to Sep. 28, 2007 has been disclaimed.

[57] CLAIM

The ornamental design for a trifold pharmaceutical tablet dispenser, as shown and described.

[**] Term: **14 Years**

DESCRIPTION

[21] Appl. No.: **14,409**

[22] Filed: **Oct. 20, 1993**

[52] U.S. Cl. **D9/346**

[58] Field of Search D9/341, 346, 347, 423, D9/424, 432, 337, 339; 206/528, 535, 538, 539, 530, 531, 532, 485, 45.2, 45.21, 45.31, 828; 220/6, 7, 507, 512, 522, 254, 377

FIG. 1 is a perspective view of a trifold pharmaceutical tablet dispenser showing our new design; FIG. 2 is a side elevational view of FIG. 1, the opposite side being a mirror image of the side shown; FIG. 3 is a tray-end elevational view of FIG. 1; FIG. 4 is a cover-end elevational view of FIG. 1; FIG. 5 is a top plan view of FIG. 1; FIG. 6 is a bottom plan view of FIG. 1; FIG. 7 is a perspective view of the trifold pharmaceutical tablet dispenser with the end-tray folded over the middle-tray.

[56] References Cited

U.S. PATENT DOCUMENTS

- D. 210,847 4/1968 Aron .
- D. 212,872 12/1968 MacLachlan et al. .
- D. 215,649 10/1969 MacLachlan et al. .
- D. 339,742 9/1993 Walchek .
- 2,285,991 6/1942 Lester 206/45.31
- 2,874,828 2/1959 Neugebauer 206/45.31
- 3,054,503 9/1962 Hartman, Jr. et al. .
- 3,283,885 11/1966 Grunewald et al. .
- 3,503,493 3/1970 Nagy .
- 3,567,013 3/1971 Tannenbaum 206/538
- 3,921,804 11/1975 Tester .
- 4,340,141 7/1982 Fischer .
- 4,693,371 9/1987 Malpass 206/539 X
- 4,919,259 4/1990 Beaulieu 206/45.2
- 4,955,481 9/1990 Novinski et al. 206/534
- 4,974,729 12/1990 Steinnagel .
- 5,082,113 1/1992 Romick .

FIG. 8 is a side elevational view of FIG. 7, the opposite side being a mirror image of the side shown; FIG. 9 is a folded tray-end elevational view of FIG. 7; FIG. 10 is a cover-end elevational view of FIG. 7; FIG. 11 is a top plan view of FIG. 7; FIG. 12 is a bottom plan view of FIG. 7; FIG. 13 is a perspective view of the trifold pharmaceutical tablet dispenser with the cover folded over the two tablet trays; FIG. 14 is a side elevational view of FIG. 13, the opposite side being a mirror image of the side shown; FIG. 15 is a front end elevational view of FIG. 13; FIG. 16 is a back end elevational view of FIG. 13; FIG. 17 is a top plan view of FIG. 13; and, FIG. 18 is a bottom plan view of FIG. 13.

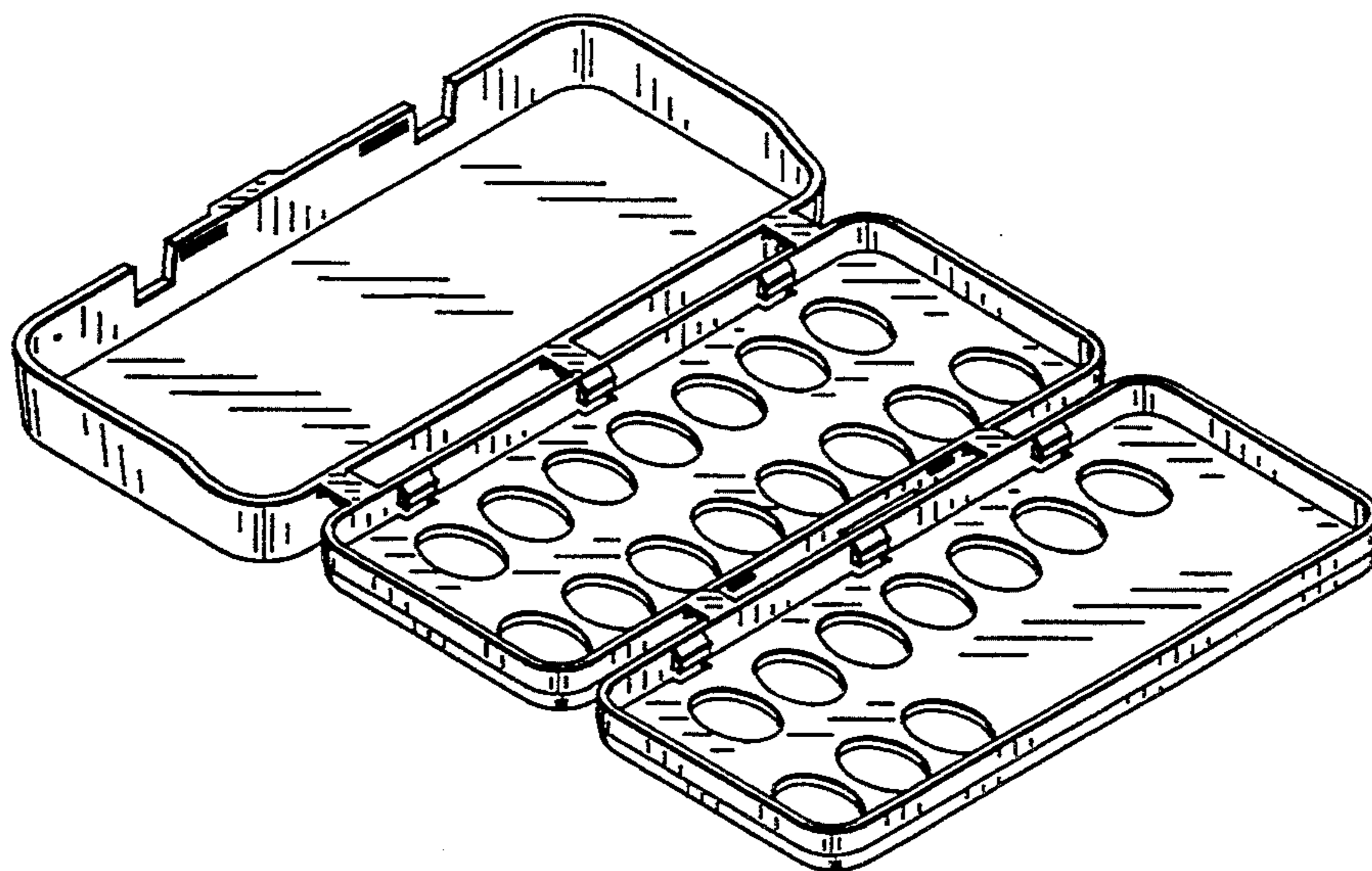

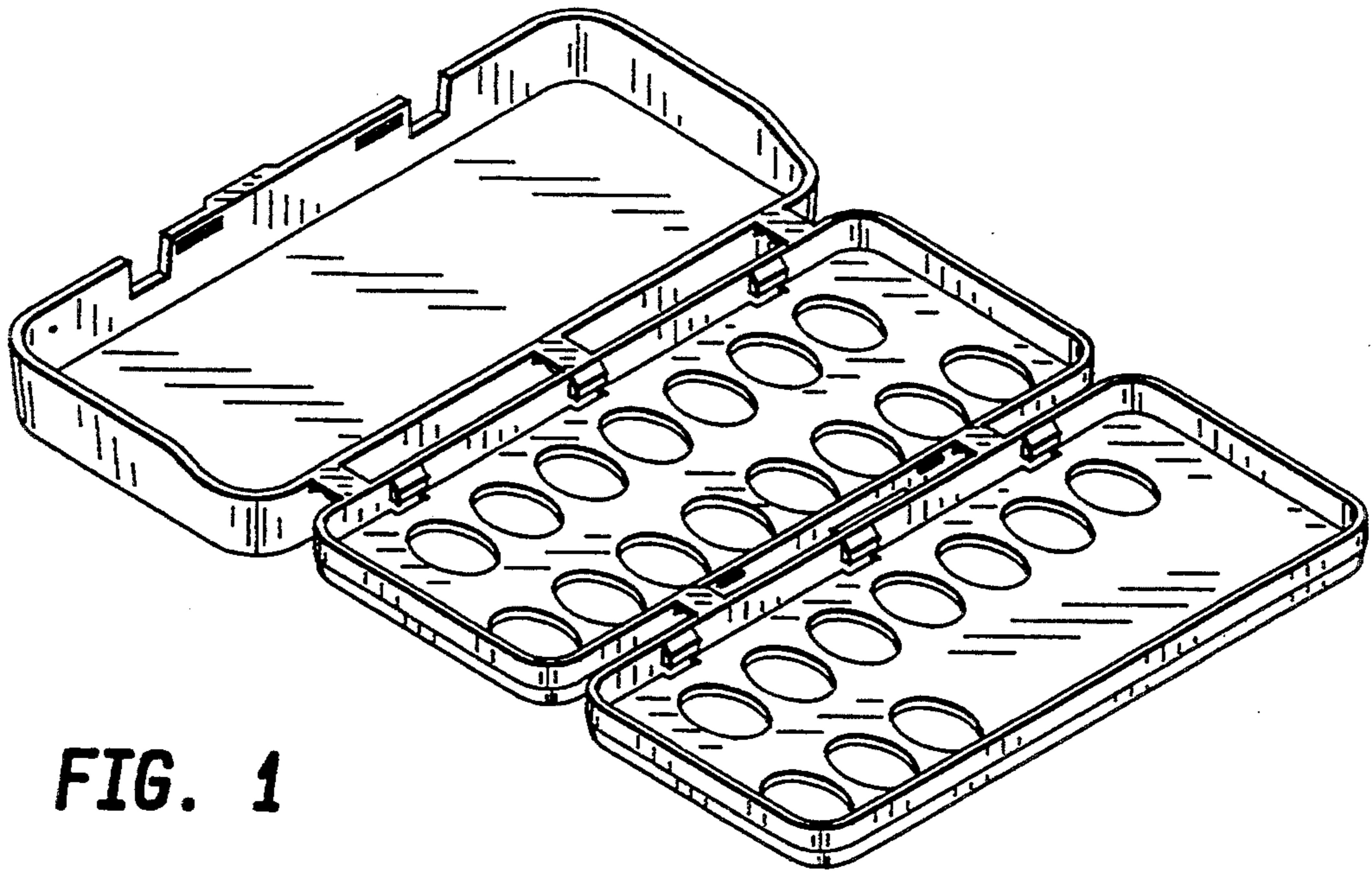

FIG. 1

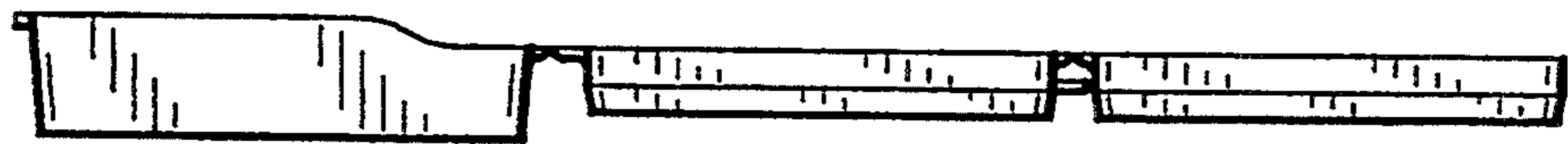

FIG. 2

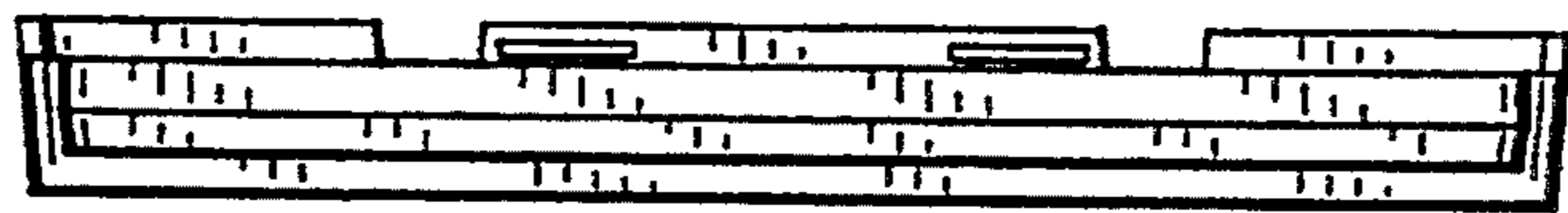

FIG. 3



FIG. 4

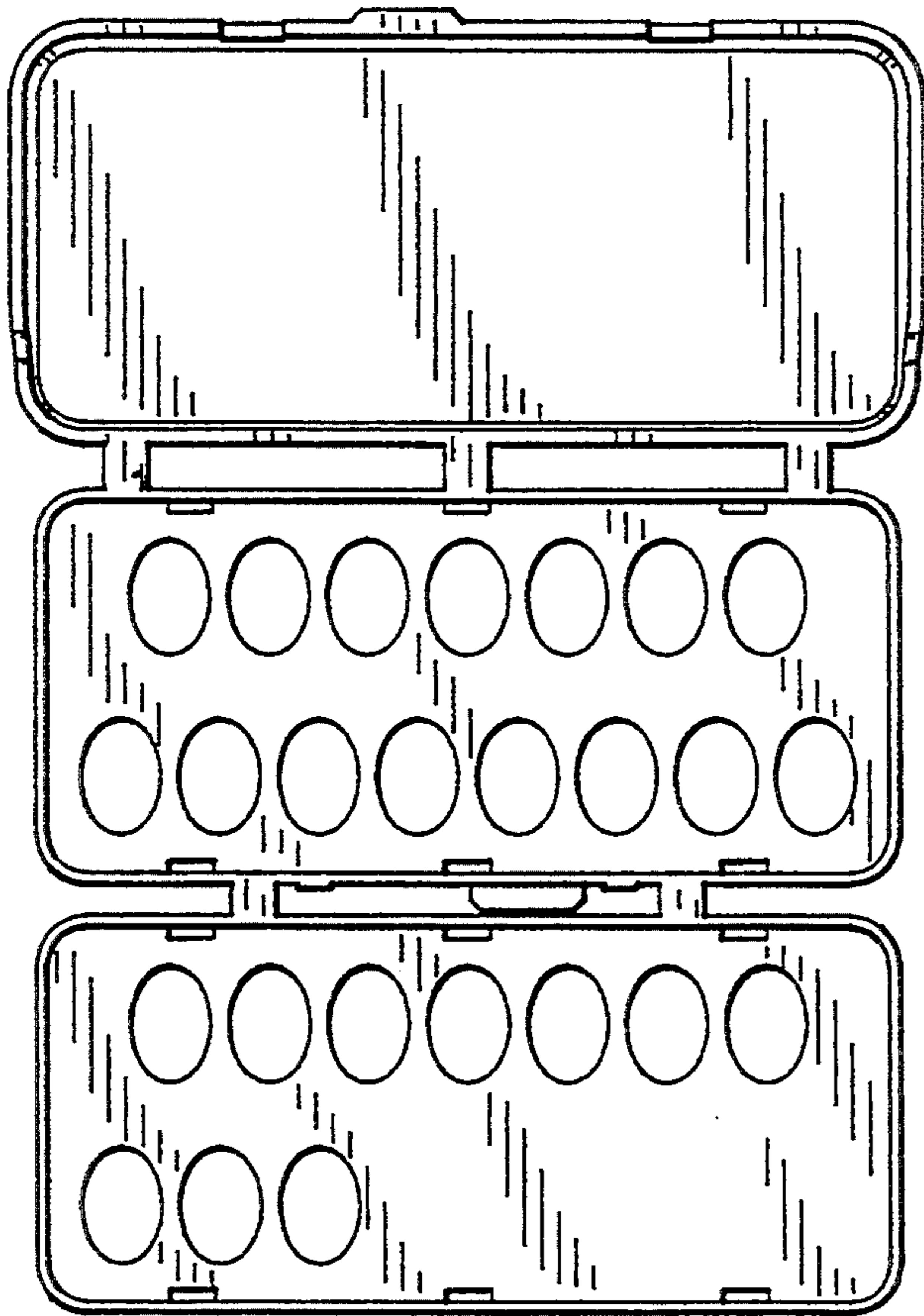

FIG. 5

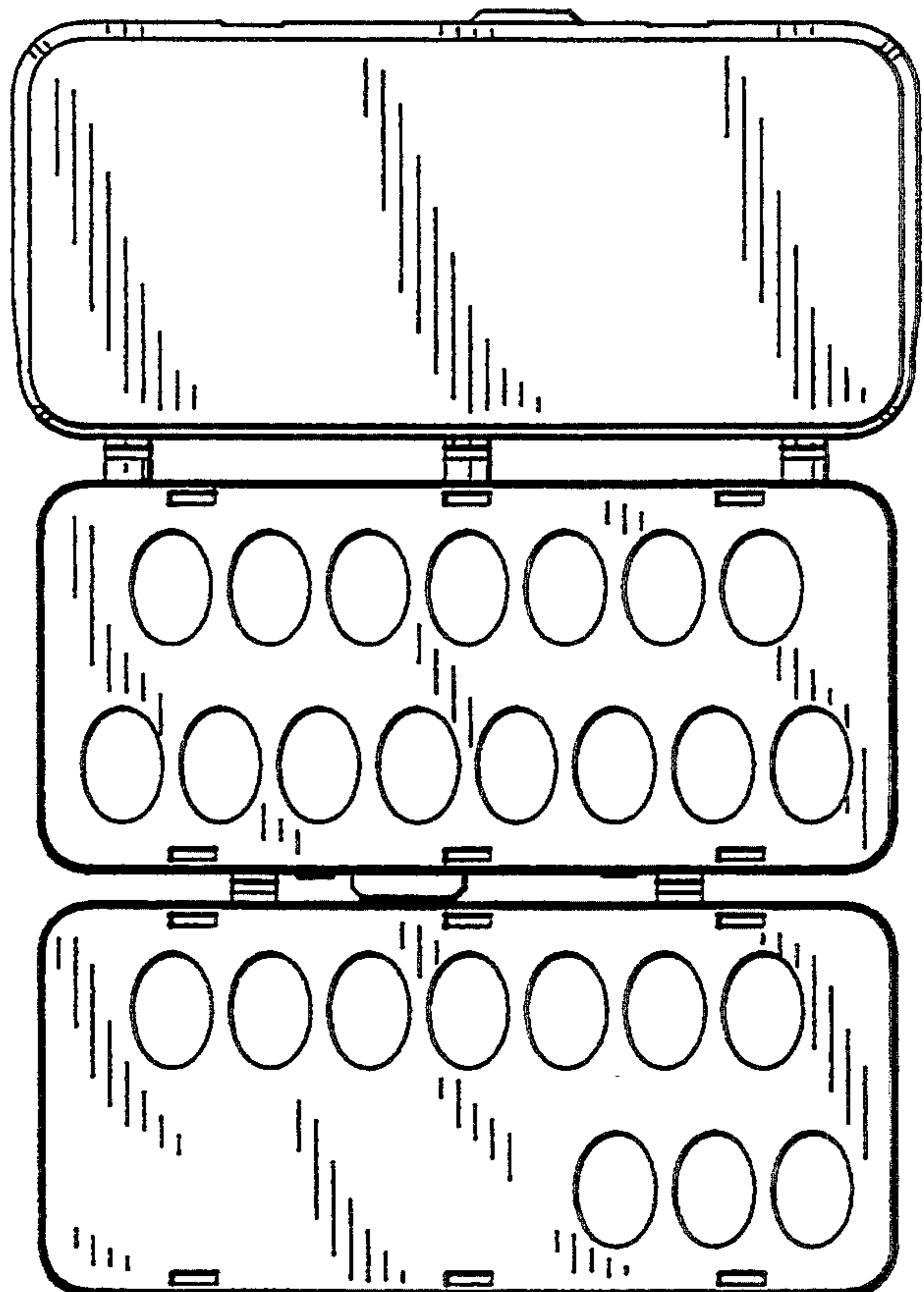

FIG. 6

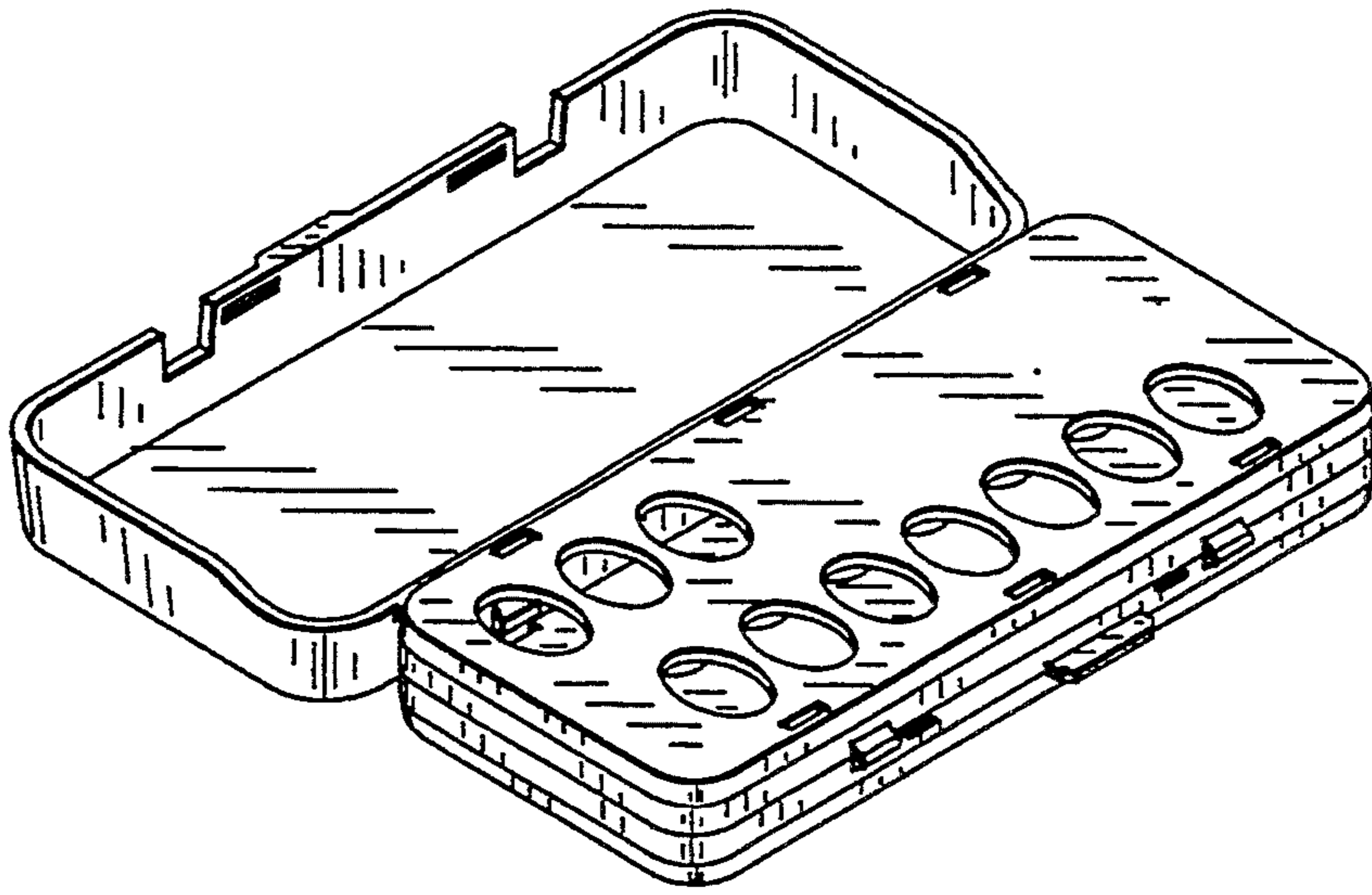

FIG. 7

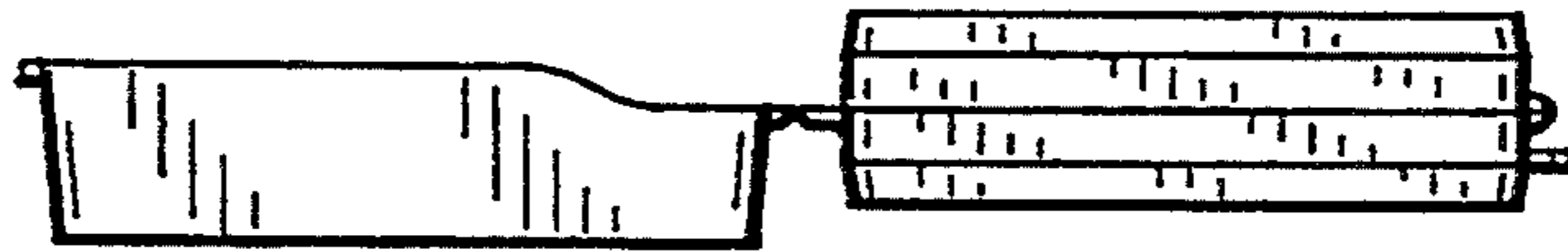

FIG. 8

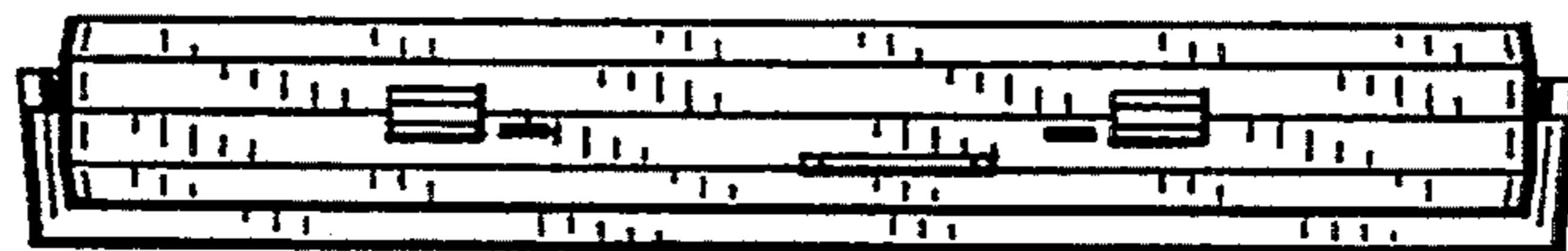

FIG. 9

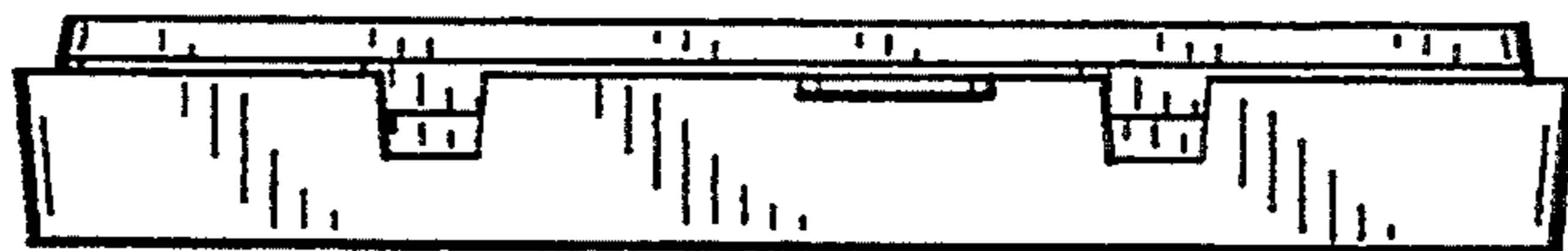

FIG. 10

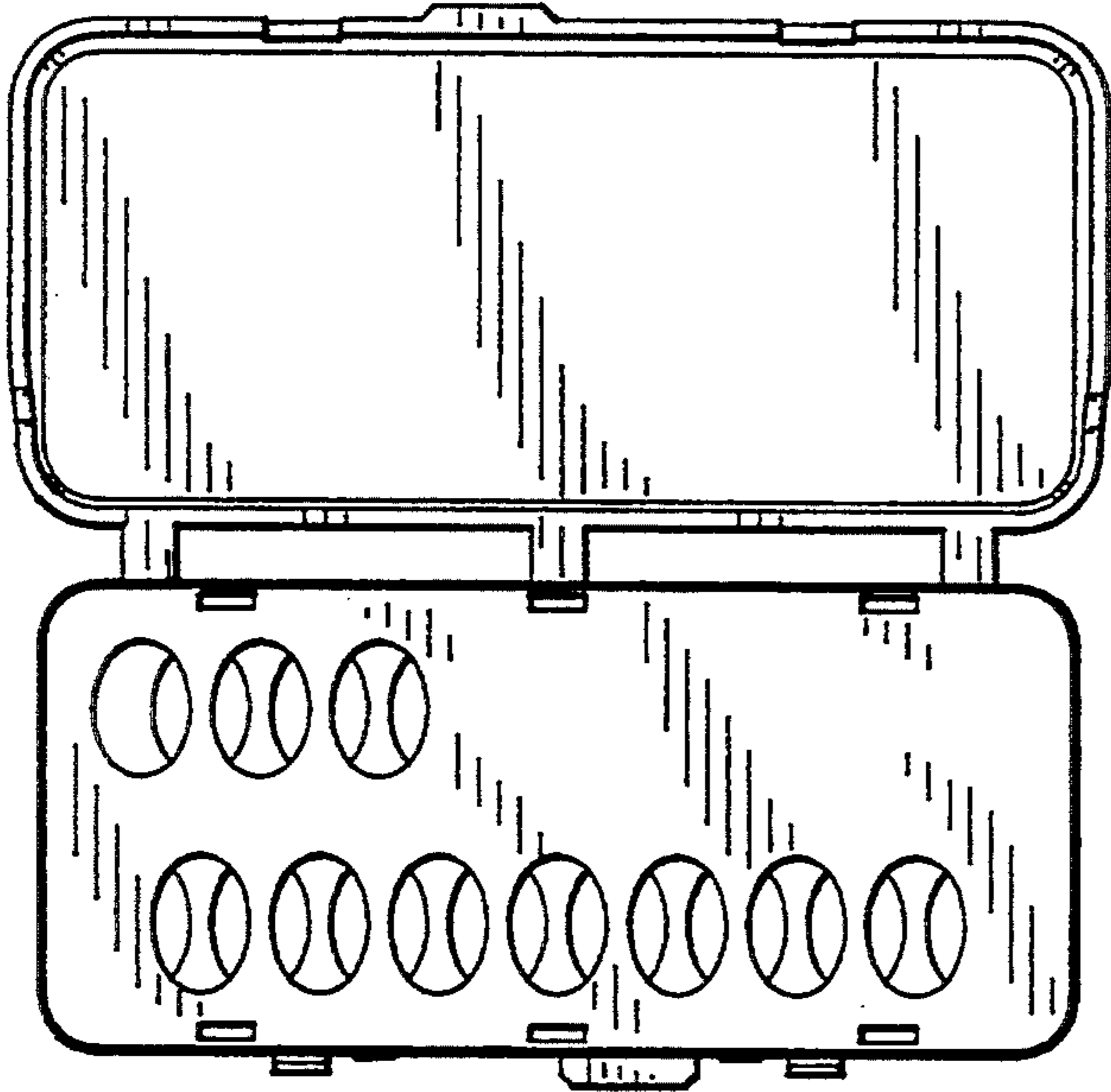

FIG. 11

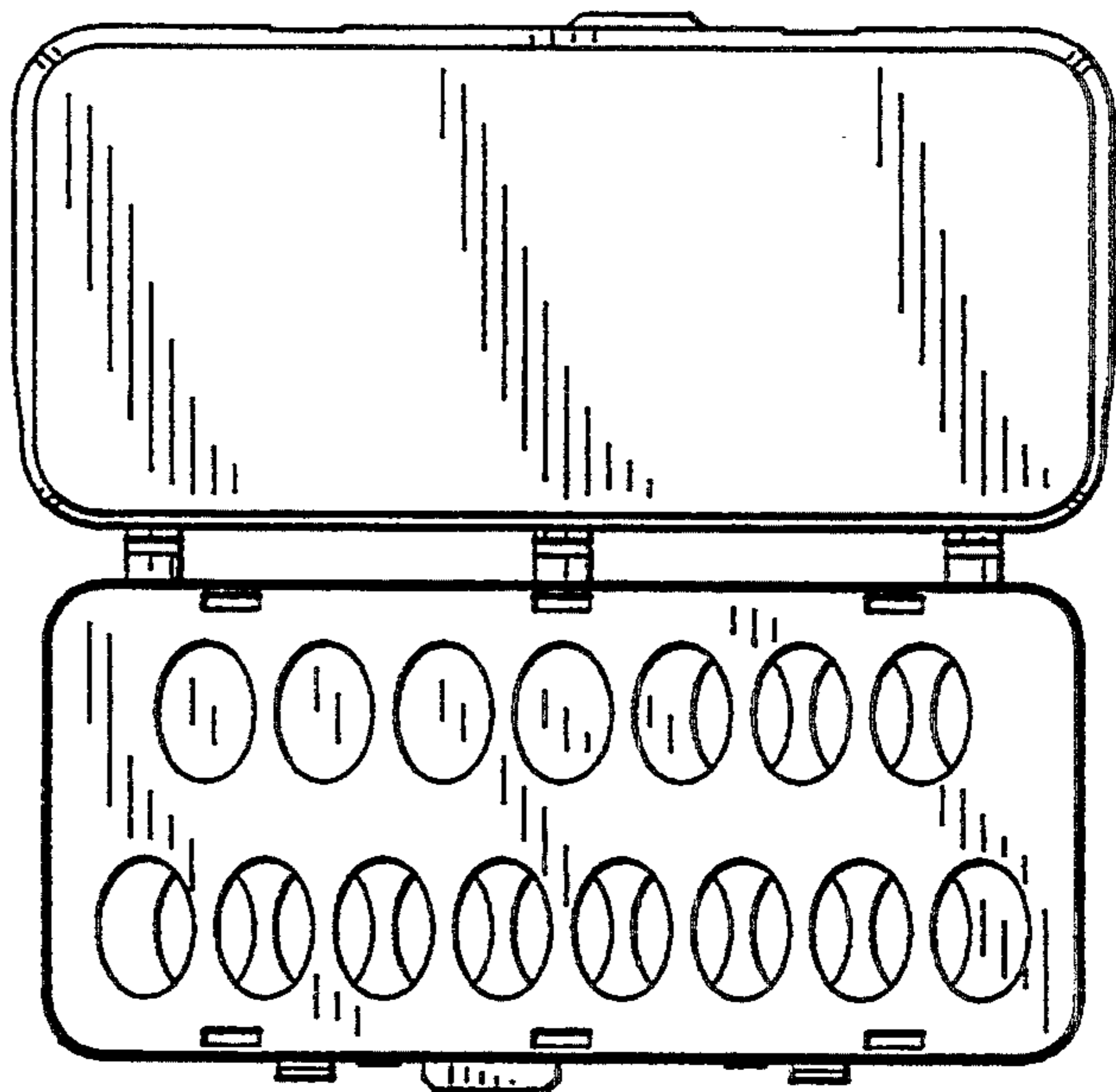

FIG. 12

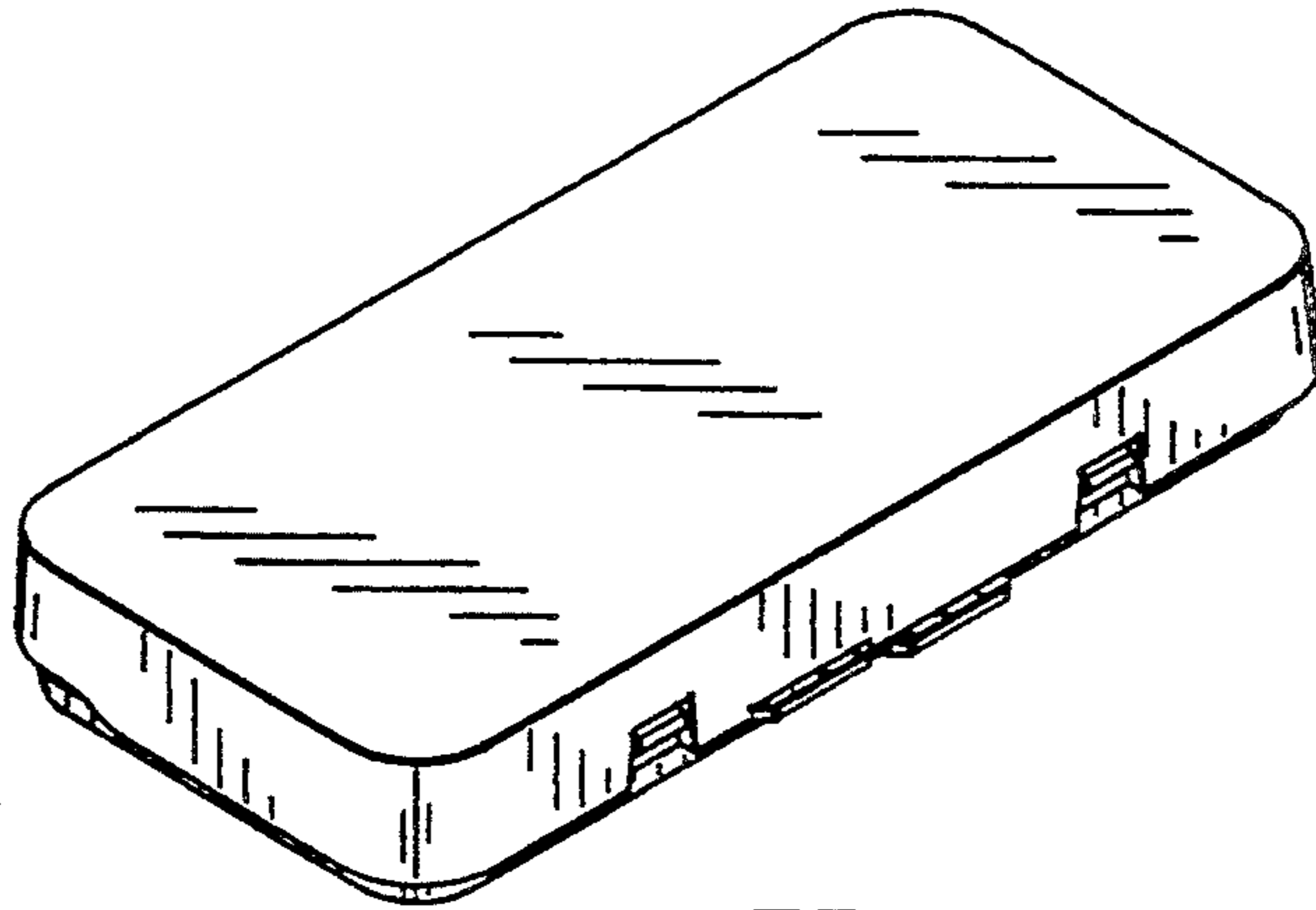

FIG. 13

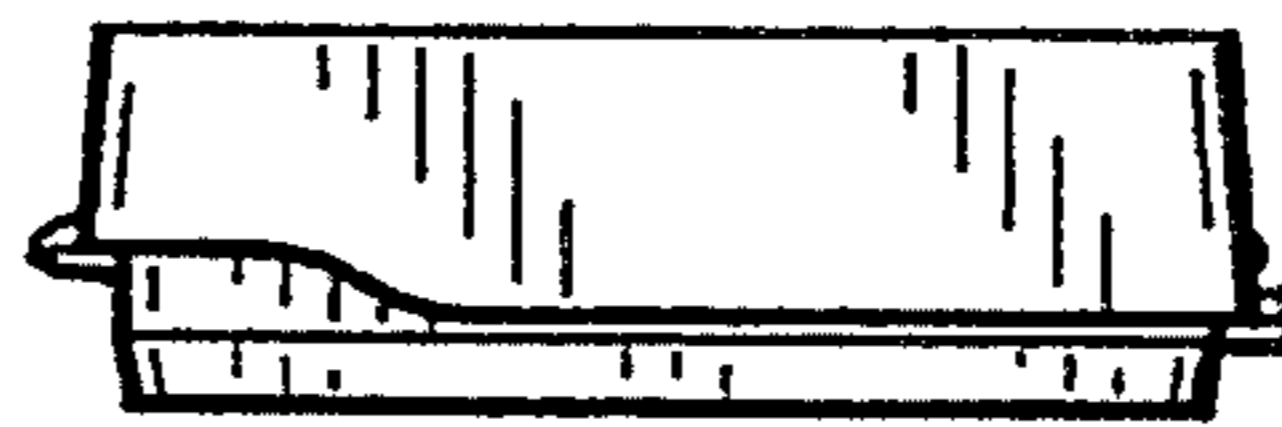

FIG. 14



FIG. 15



FIG. 16

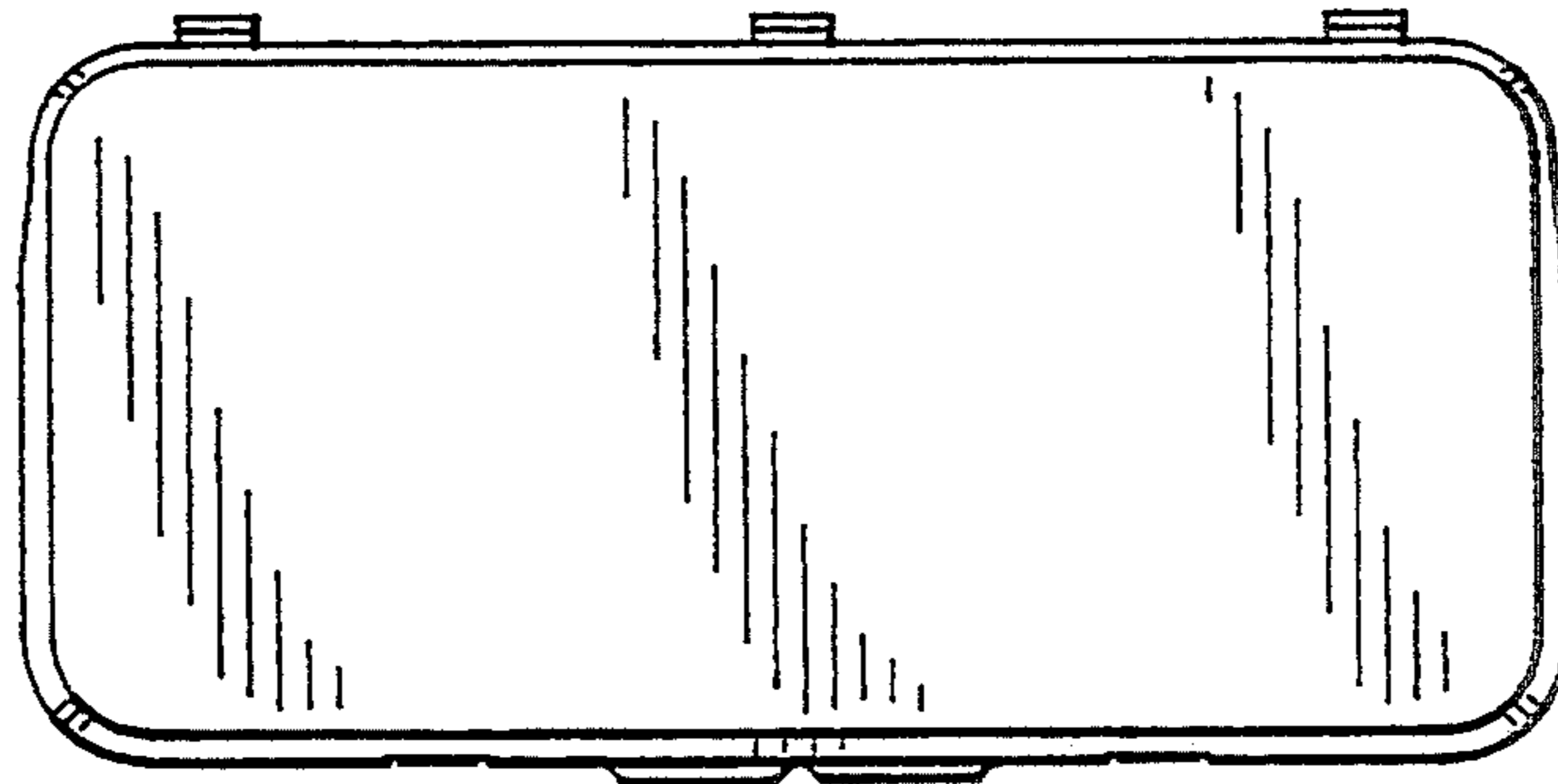

FIG. 17

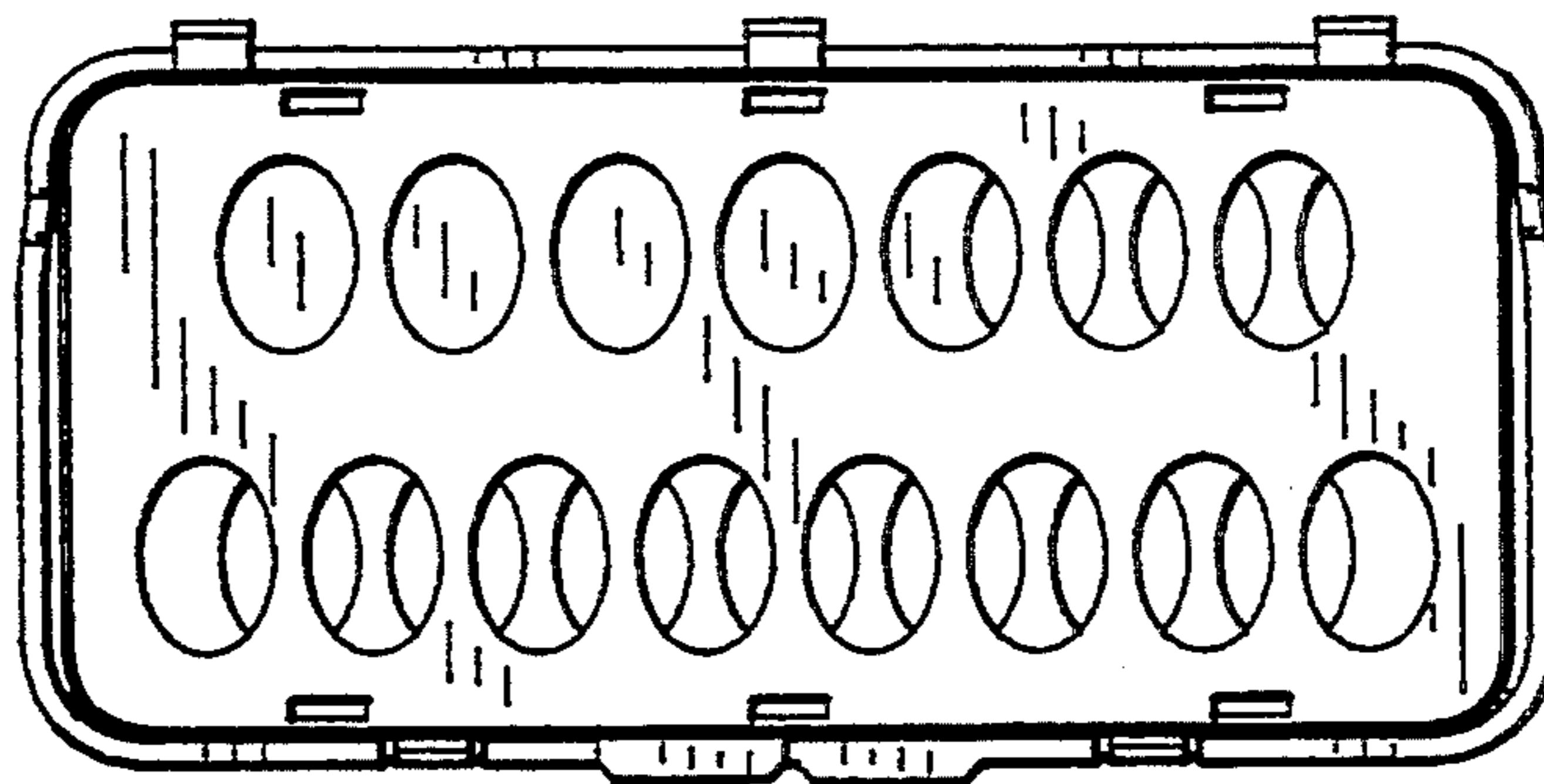

FIG. 18