



US00D358589S

# United States Patent [19]

[11] Patent Number: **Des. 358,589**

Dann et al.

[45] Date of Patent: **\*\* May 23, 1995**

[54] **KEYBOARD**

[75] Inventors: **Michael S. Dann**, Mountain View;  
**Paul S. Montgomery**; **Herbert H. F. Pfeifer**, both of San Francisco, all of Calif.

[73] Assignee: **Sun Microsystems, Inc.**, Mountain View, Calif.

[\*\*] Term: **14 Years**

[21] Appl. No.: **10,687**

[22] Filed: **Jul. 14, 1993**

[52] U.S. Cl. .... **D14/115**

[58] Field of Search ..... **D14/100, 101, 106, 115;**  
**D18/1, 2, 7, 11, 12; 235/145 A, 145 R; 345/168;**  
**341/22, 23; 364/708.1; 400/472, 479, 484-486,**  
**488, 489**

[56]

**References Cited**

**PUBLICATIONS**

SPARCStation 10 marketing brochure. Nov. 1992.

*Primary Examiner*—Freda S. Nunn  
*Attorney, Agent, or Firm*—Erwin J. Basinski

[57]

**CLAIM**

The ornamental design for a keyboard, as shown and described.

**DESCRIPTION**

FIG. 1 is a reduced front perspective view of the keyboard showing our new design;  
FIG. 2 is a top view thereof;  
FIG. 3 is a bottom view thereof;  
FIG. 4 is a front view thereof;  
FIG. 5 is a back view thereof;  
FIG. 6 is a right side view thereof;  
FIG. 7 is a left side view thereof;  
FIG. 8 is a right side view thereof showing a rear foot extended; and,  
FIG. 9 is a rear perspective view thereof.

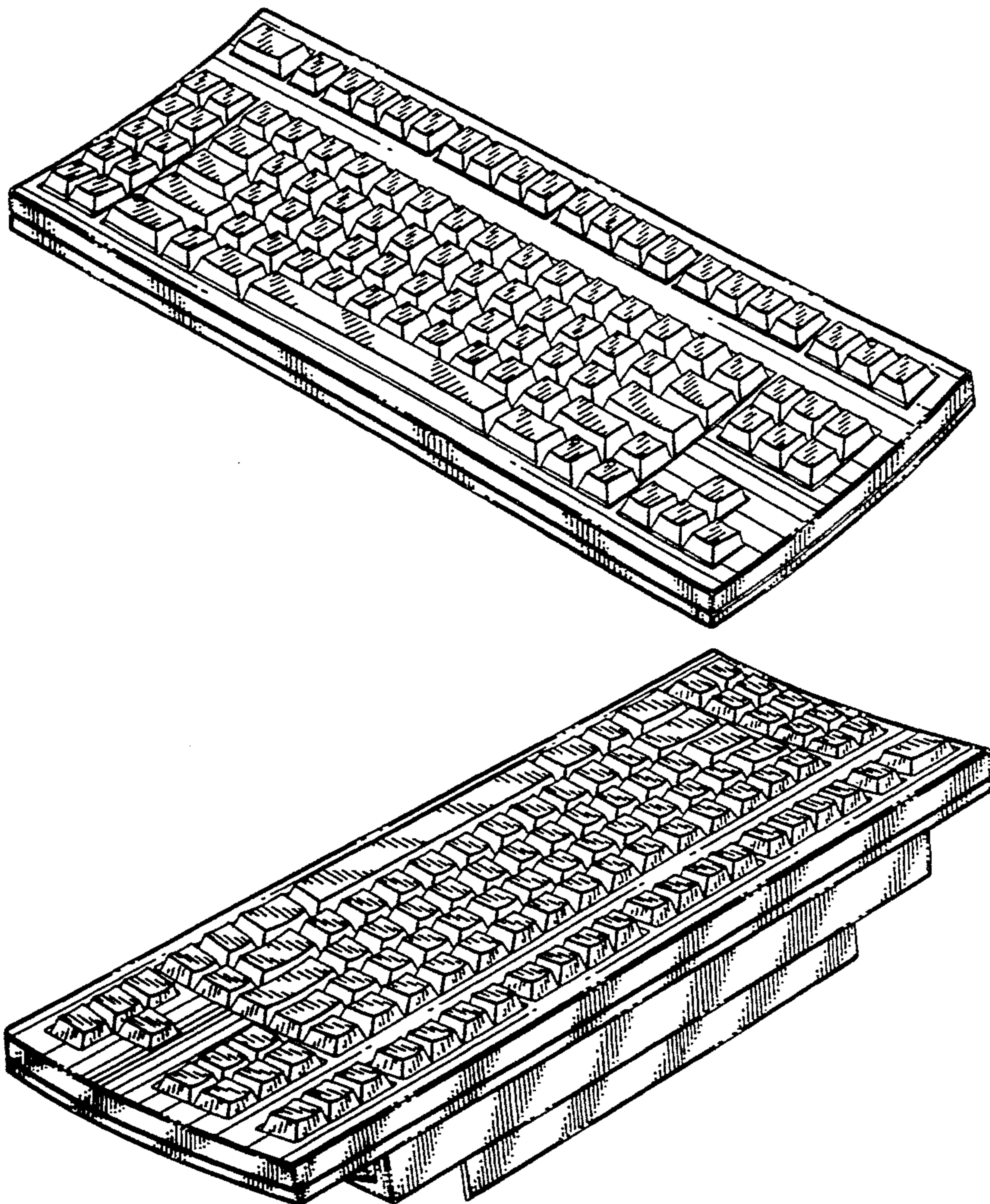

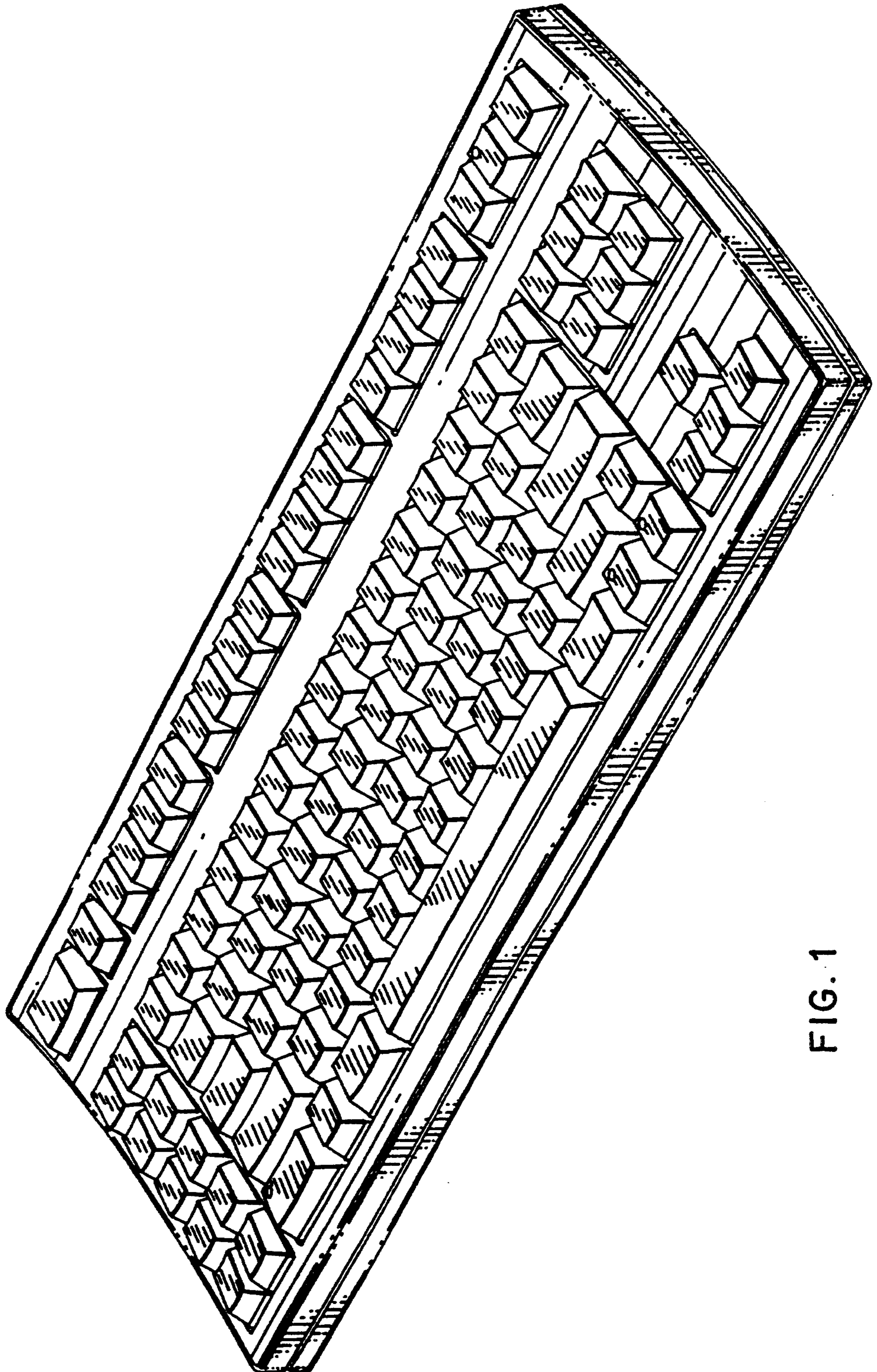

FIG. 1

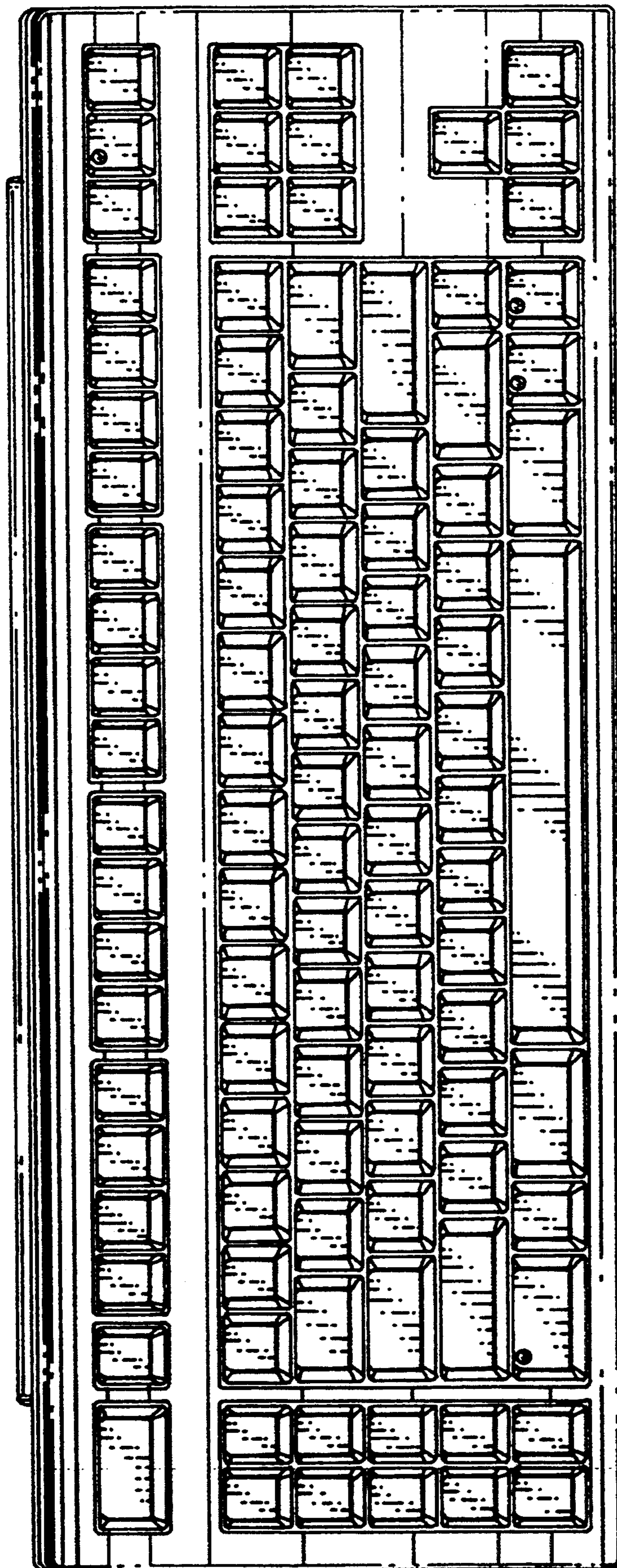

FIG. 2

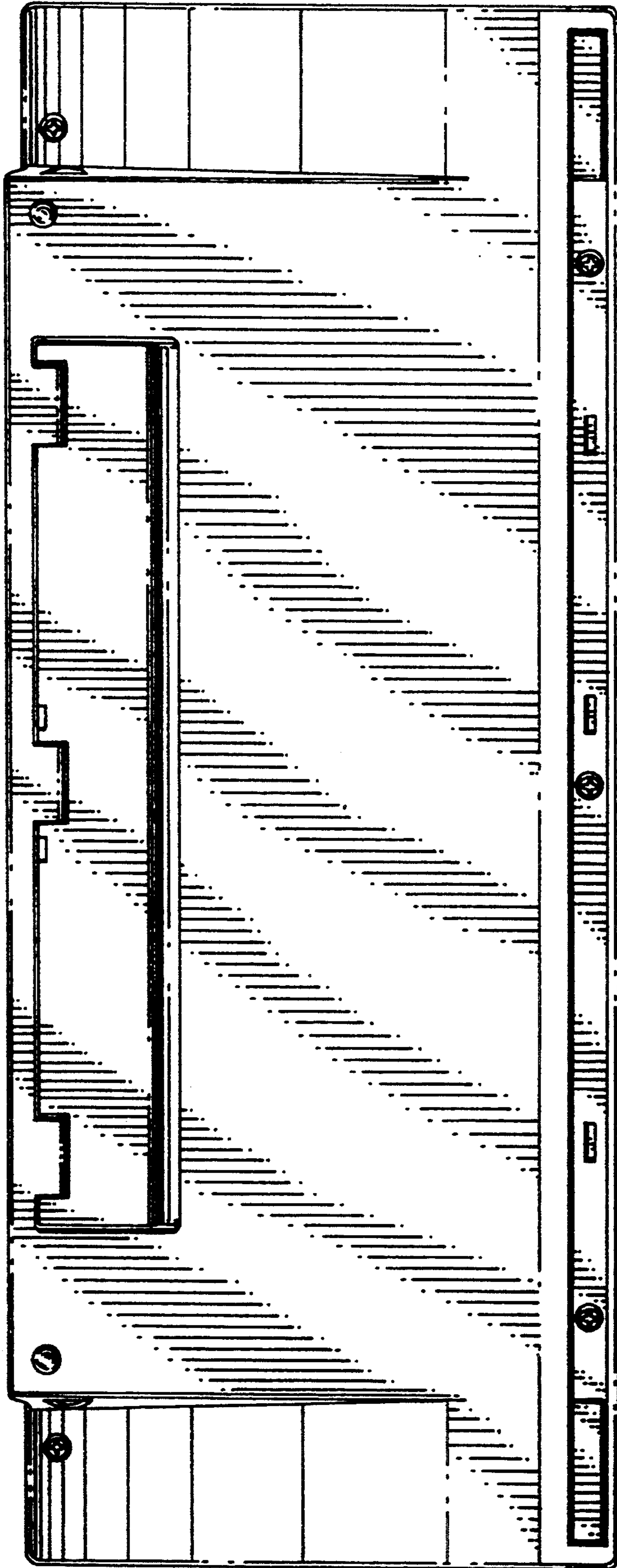

FIG. 3

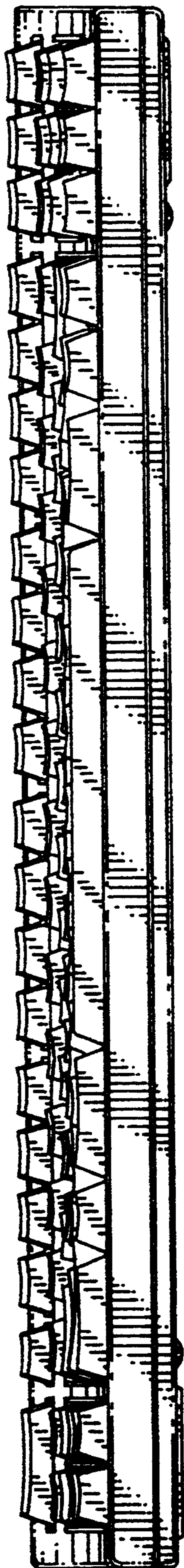

FIG. 4

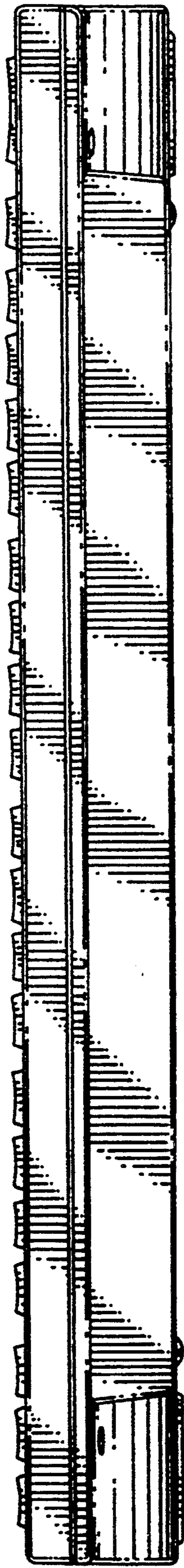

FIG. 5

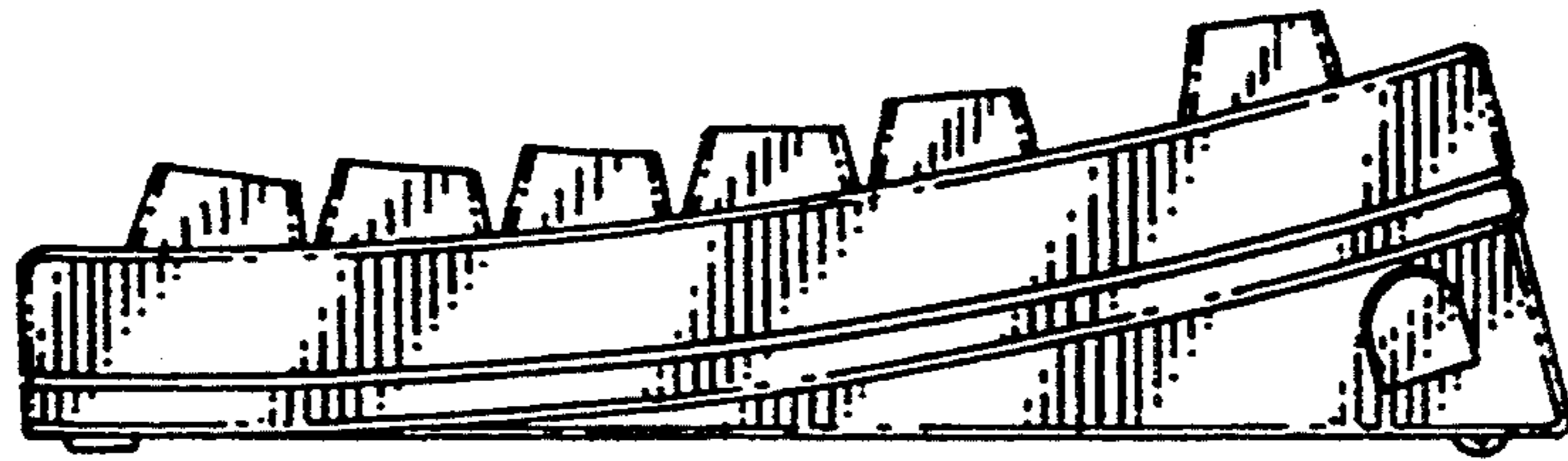

FIG. 6

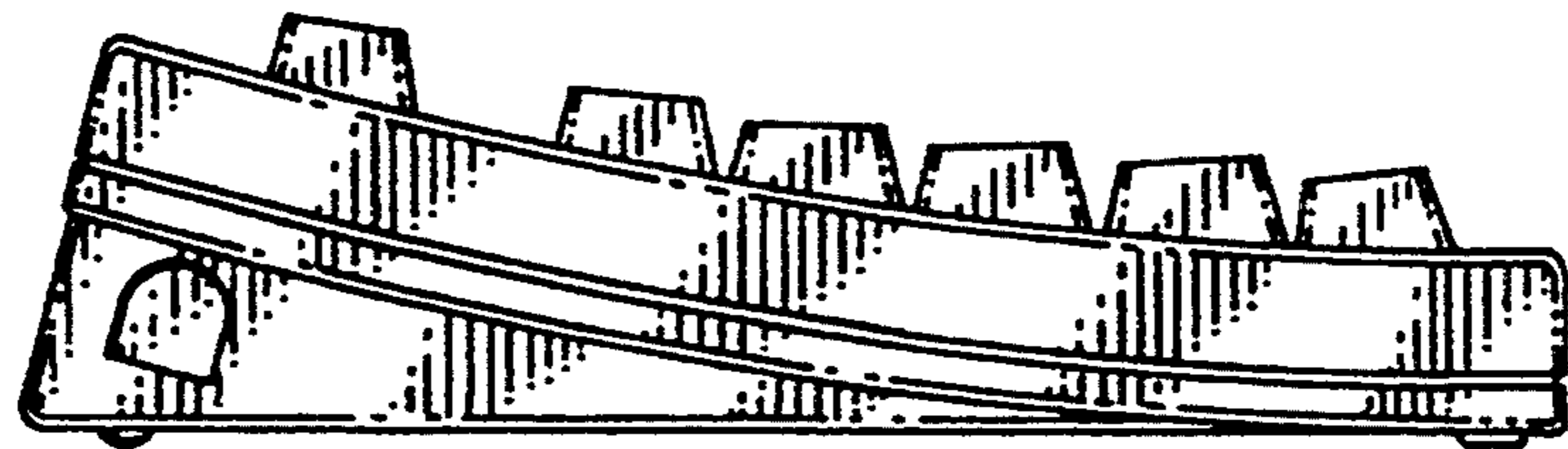

FIG. 7

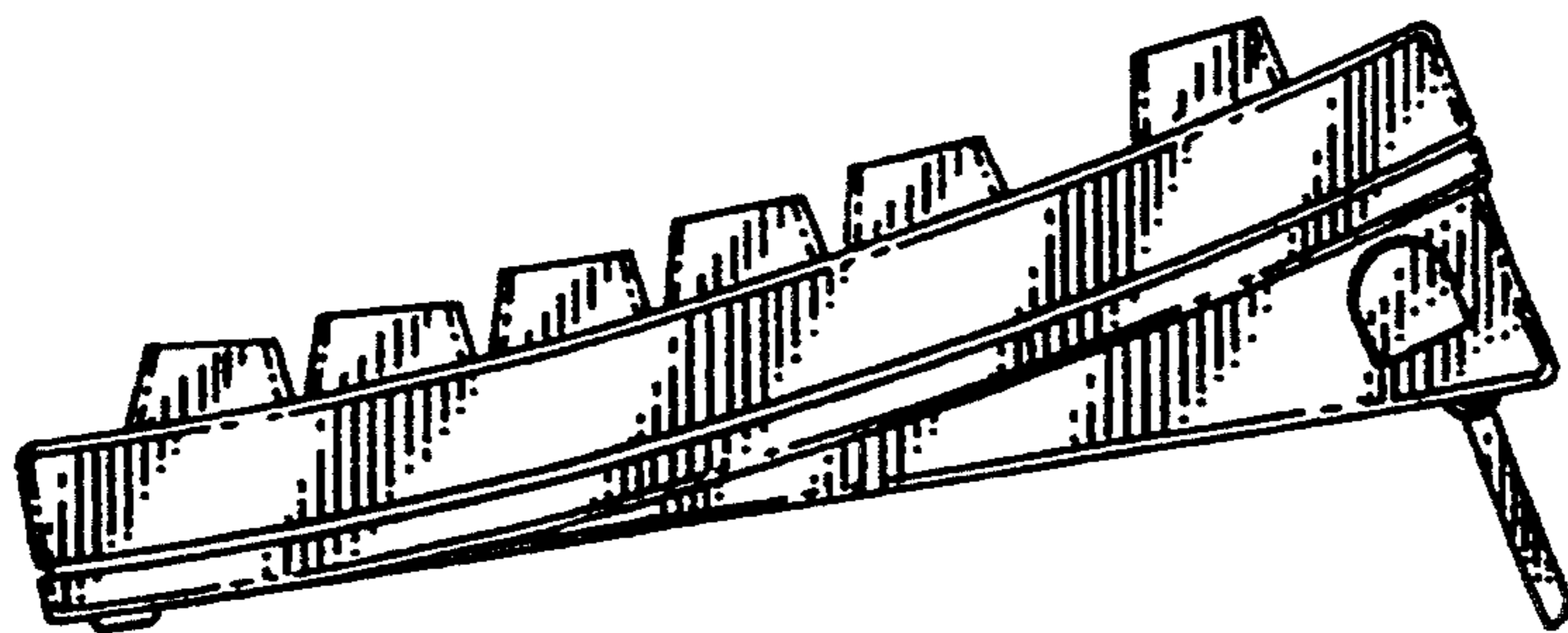

FIG. 8

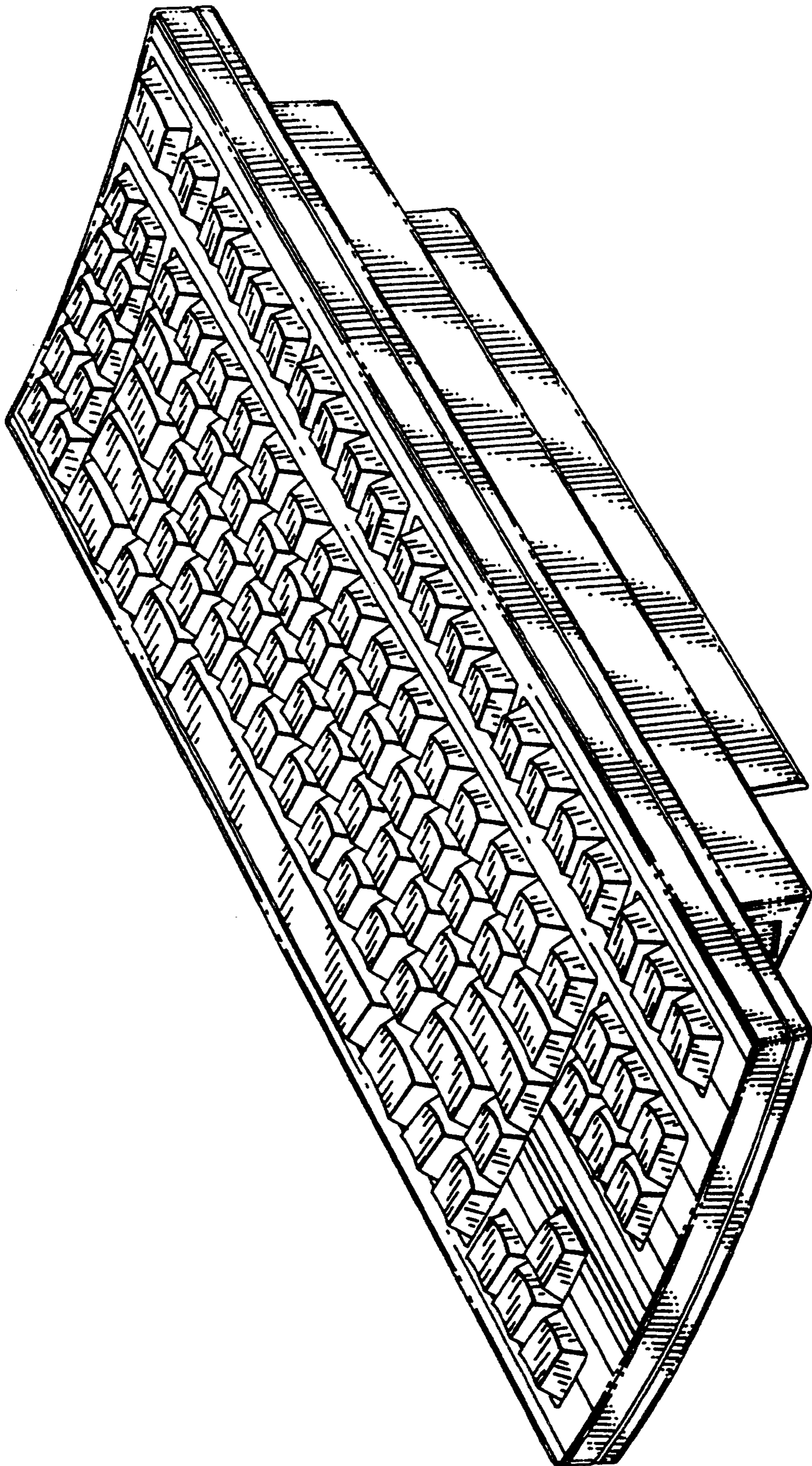

FIG. 9