



US00D358494S

# United States Patent [19]

[11] Patent Number: **Des. 358,494**

Baerenwald et al.

[45] Date of Patent: **\*\* May 23, 1995**

[54] MULTIPURPOSE HIGHCHAIR

[57] CLAIM

[75] Inventors: **Philip M. Baerenwald; Peter J. Myers**, both of Plano, Tex.

The ornamental design for the multipurpose highchair, as shown and described.

[73] Assignee: **Today's Kids, Inc.**, Booneville, Ark.

### DESCRIPTION

[\*\*] Term: **14 Years**

FIG. 1 is a front elevational view of a multipurpose highchair with the seat thereof in one position showing our new design;

[21] Appl. No.: **18,383**

FIG. 2 is a top view of the multipurpose highchair illustrated in FIG. 1;

[22] Filed: **Feb. 4, 1994**

FIG. 3 is a right side elevational view of the multipurpose highchair illustrated in FIG. 1;

[52] U.S. Cl. .... **D6/339**

FIG. 4 is a left side elevational view of the multipurpose highchair illustrated in FIG. 1;

[58] Field of Search ..... **D6/333, 334, 335, 338, D6/339, 367; 297/148-150, 487, 274, 275, 273, 281, 282; 5/101, 105**

FIG. 5 is a rear elevational view of the multipurpose highchair illustrated in FIG. 1;

FIG. 6 is a bottom view of the multipurpose highchair illustrated in FIG. 1;

### [56] References Cited

#### U.S. PATENT DOCUMENTS

|            |         |                  |       |         |
|------------|---------|------------------|-------|---------|
| D. 169,271 | 4/1953  | McWaide          | ..... | D6/333  |
| D. 181,975 | 1/1958  | Hail et al.      | ..... | D6/339  |
| D. 236,766 | 9/1975  | Speer            | ..... | D6/333  |
| D. 305,584 | 1/1990  | Spilman et al.   | ..... | D6/34   |
| D. 311,822 | 11/1990 | Meeker           | ..... | D6/333  |
| 2,478,236  | 8/1949  | Carr             | ..... | 297/487 |
| 3,731,420  | 5/1973  | Crosman          | ..... | 46/1 R  |
| 4,271,627  | 6/1981  | Echterling       | ..... | 46/15   |
| 4,664,396  | 5/1987  | Pietrafesa       | ..... | 280/30  |
| 4,744,599  | 5/1988  | Jankowski et al. | ..... | 297/250 |
| 5,238,291  | 8/1993  | Alionis          | ..... | 297/118 |

FIG. 7 is a front elevational view of the multipurpose highchair illustrated in FIG. 1 with the seat thereof in a second position;

FIG. 8 is a top view of the multipurpose highchair illustrated in FIG. 7;

FIG. 9 is a right side elevational view of the multipurpose highchair of FIG. 7;

FIG. 10 is a left side elevational view of the multipurpose highchair of FIG. 7;

FIG. 11 is a rear elevational view of the multipurpose highchair of FIG. 7; and,

FIG. 12 is a bottom view of the multipurpose highchair of FIG. 7;

FIG. 13 is a perspective view of the multipurpose highchair of FIGS. 1-6; and,

FIG. 14 is a perspective view of the multipurpose highchair of FIGS. 7-12.

Primary Examiner—Janice E. Seeger  
Attorney, Agent, or Firm—Kirkpatrick & Lockhart

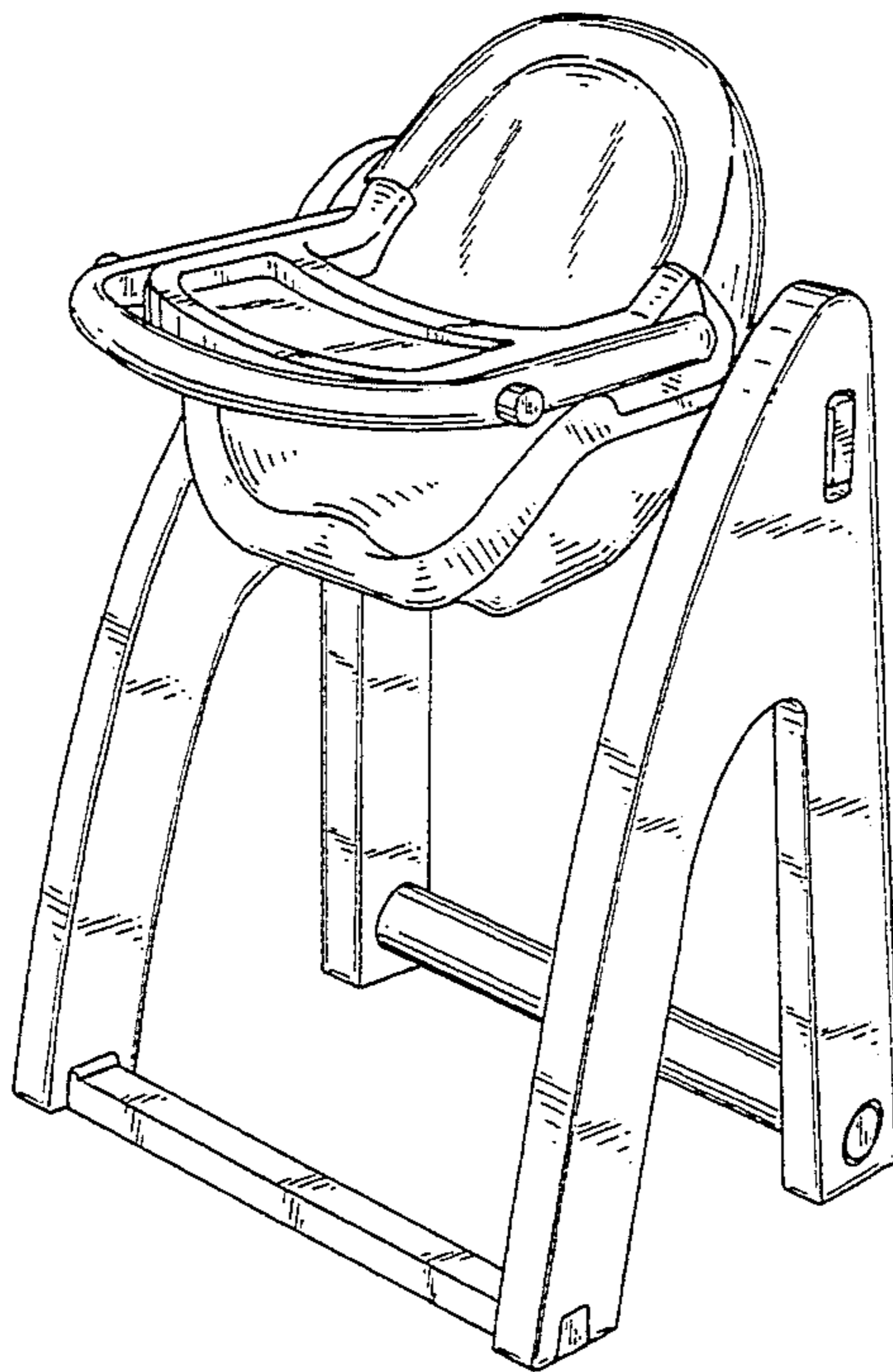

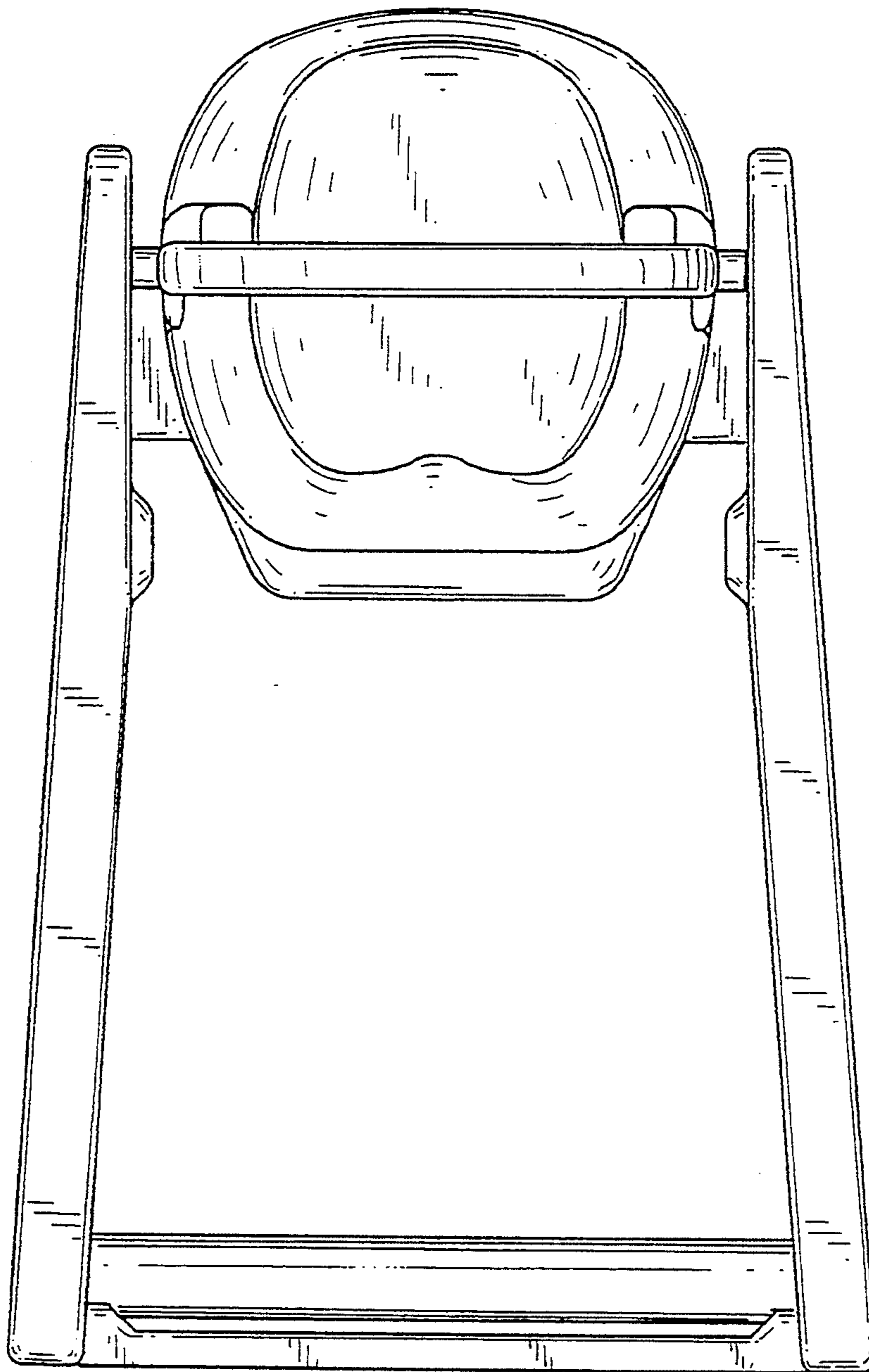

FIG. 1

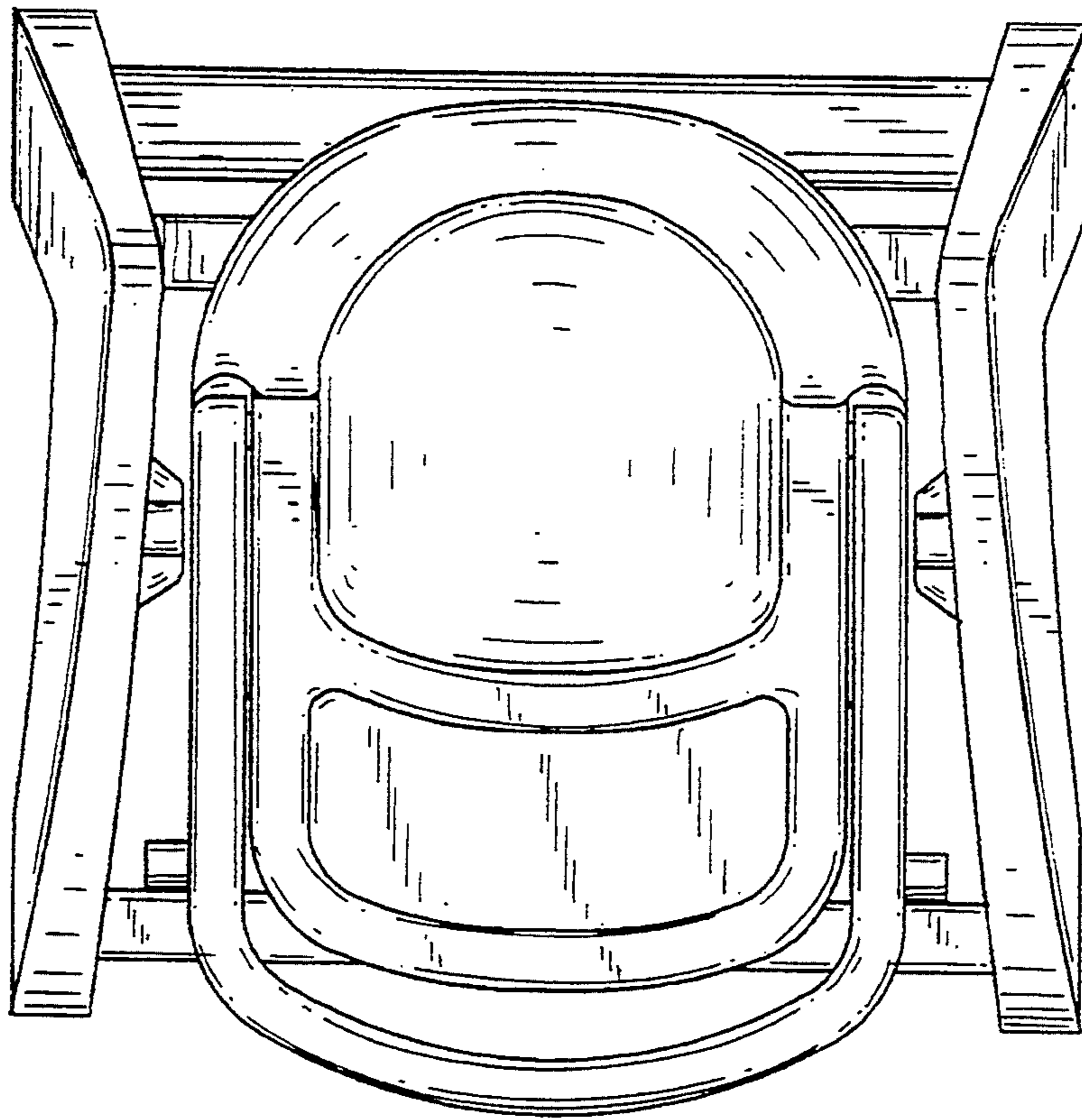

FIG. 2

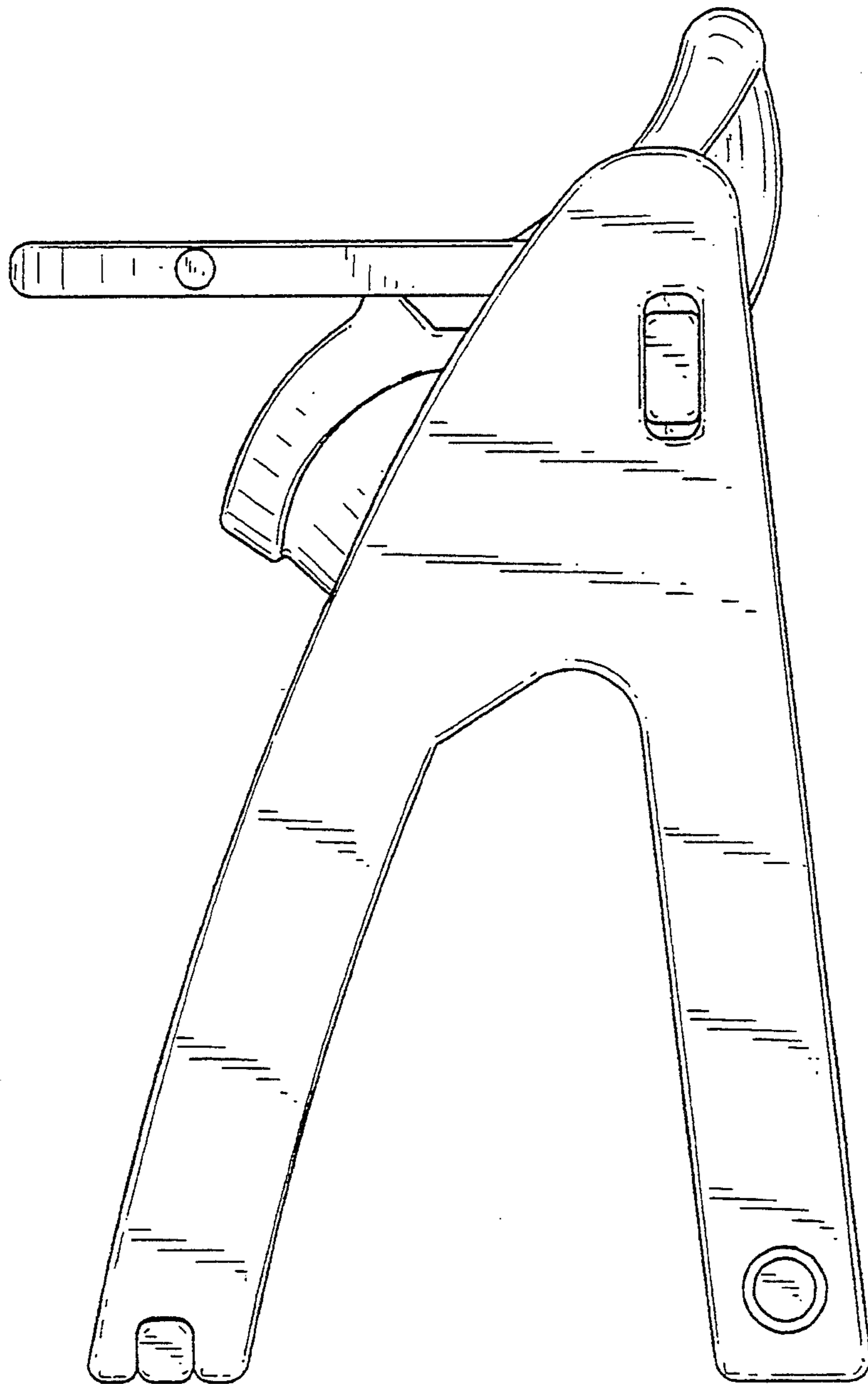

FIG. 3



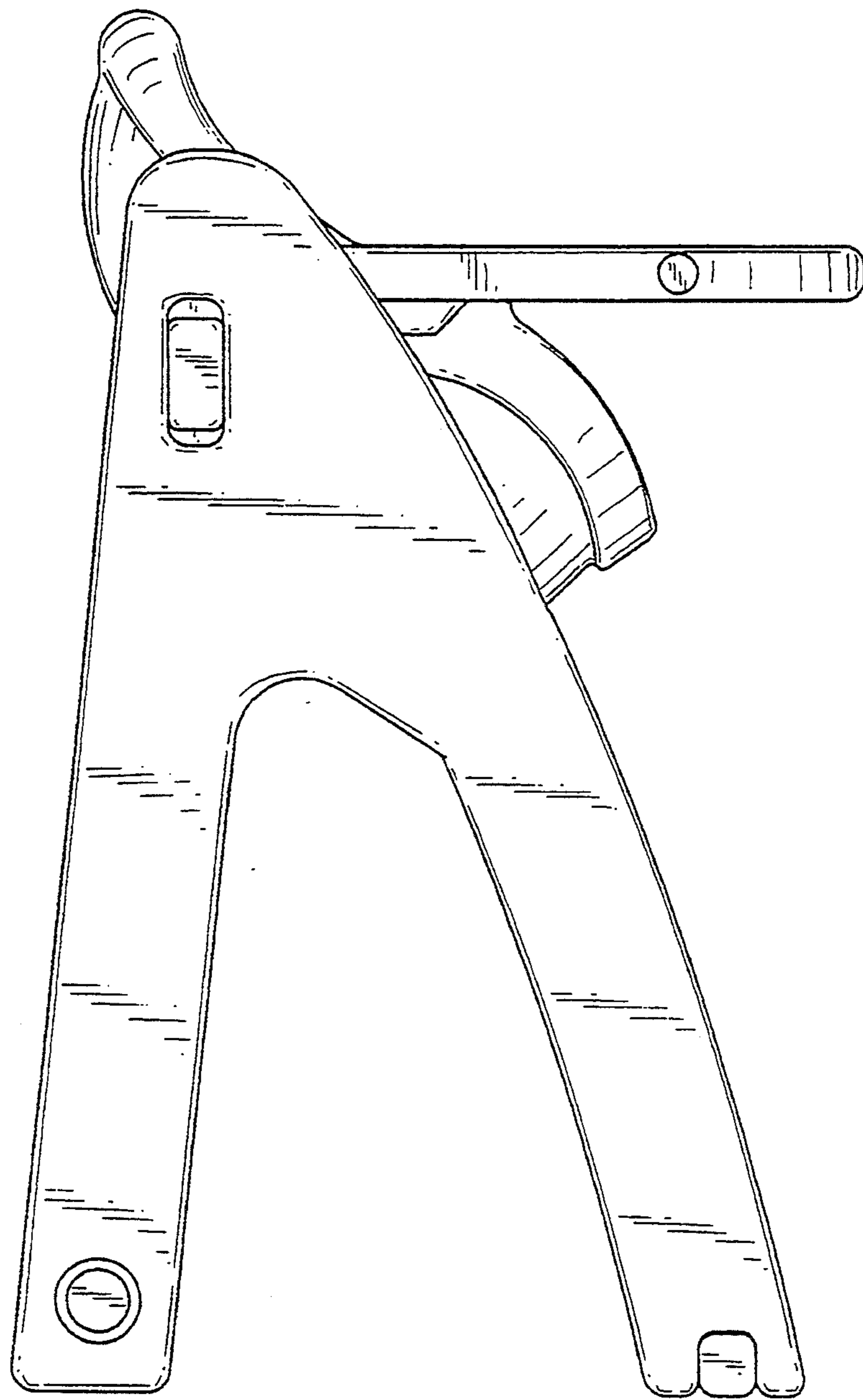

FIG. 4

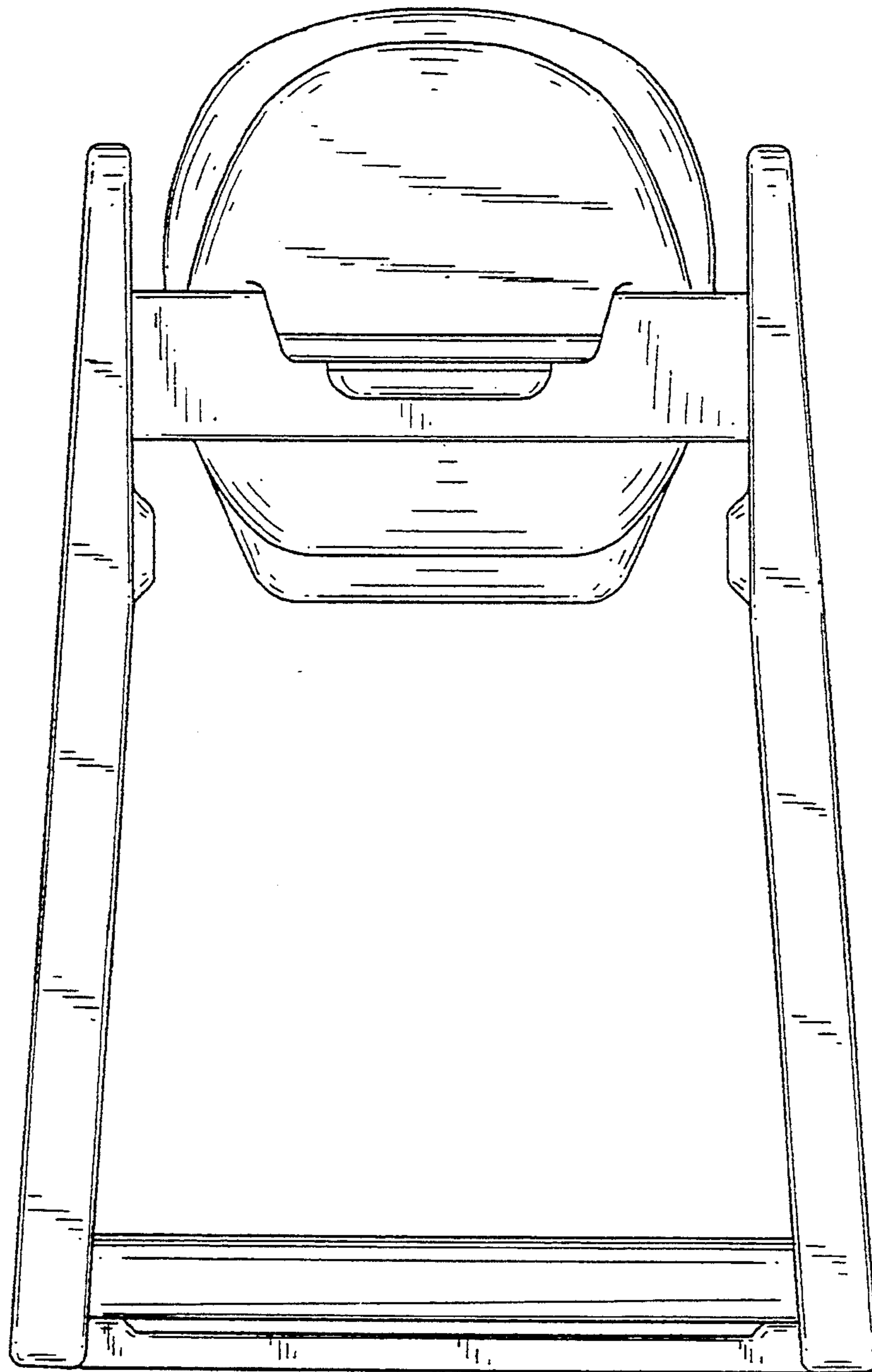

FIG. 5

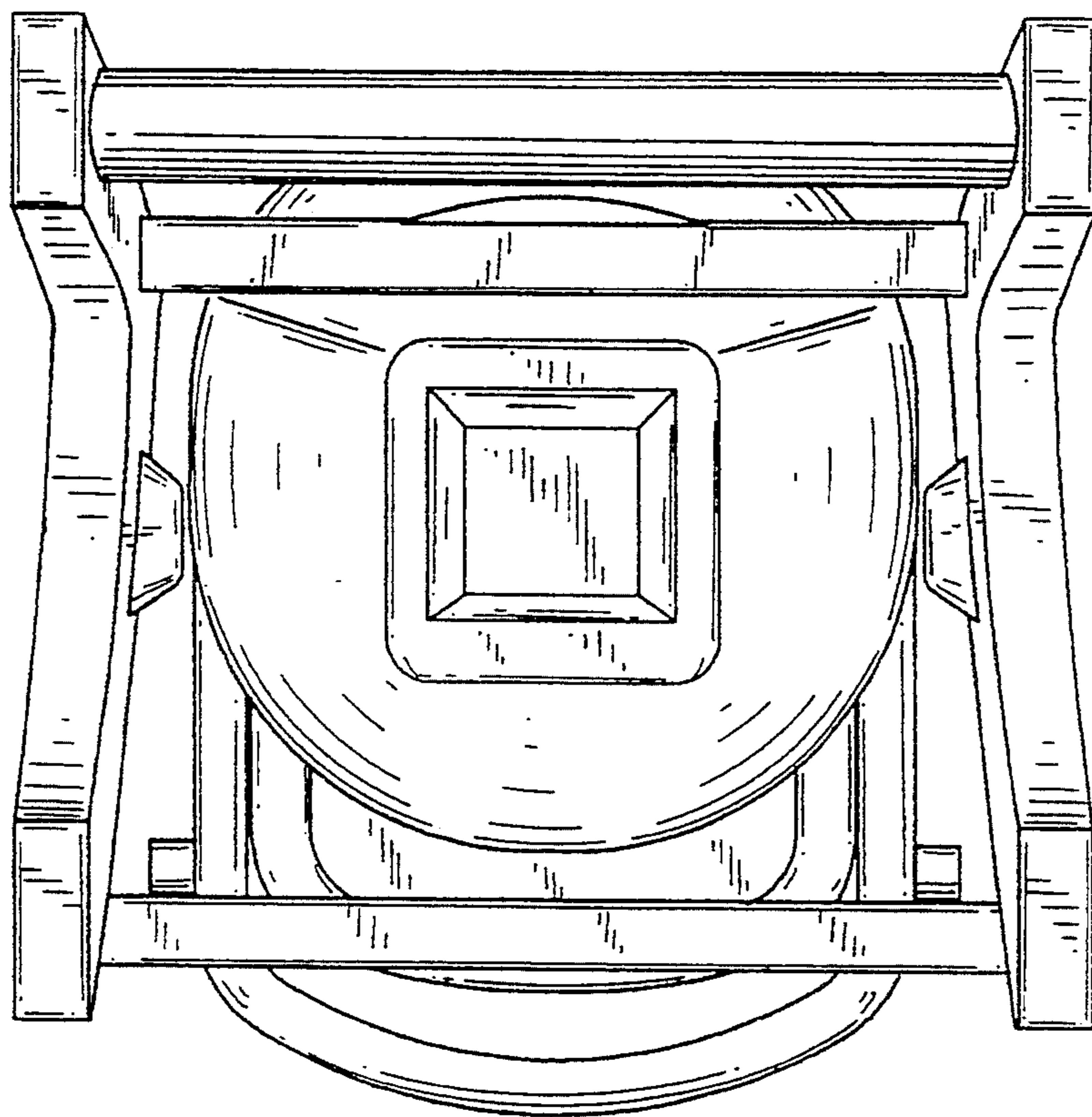

FIG. 6

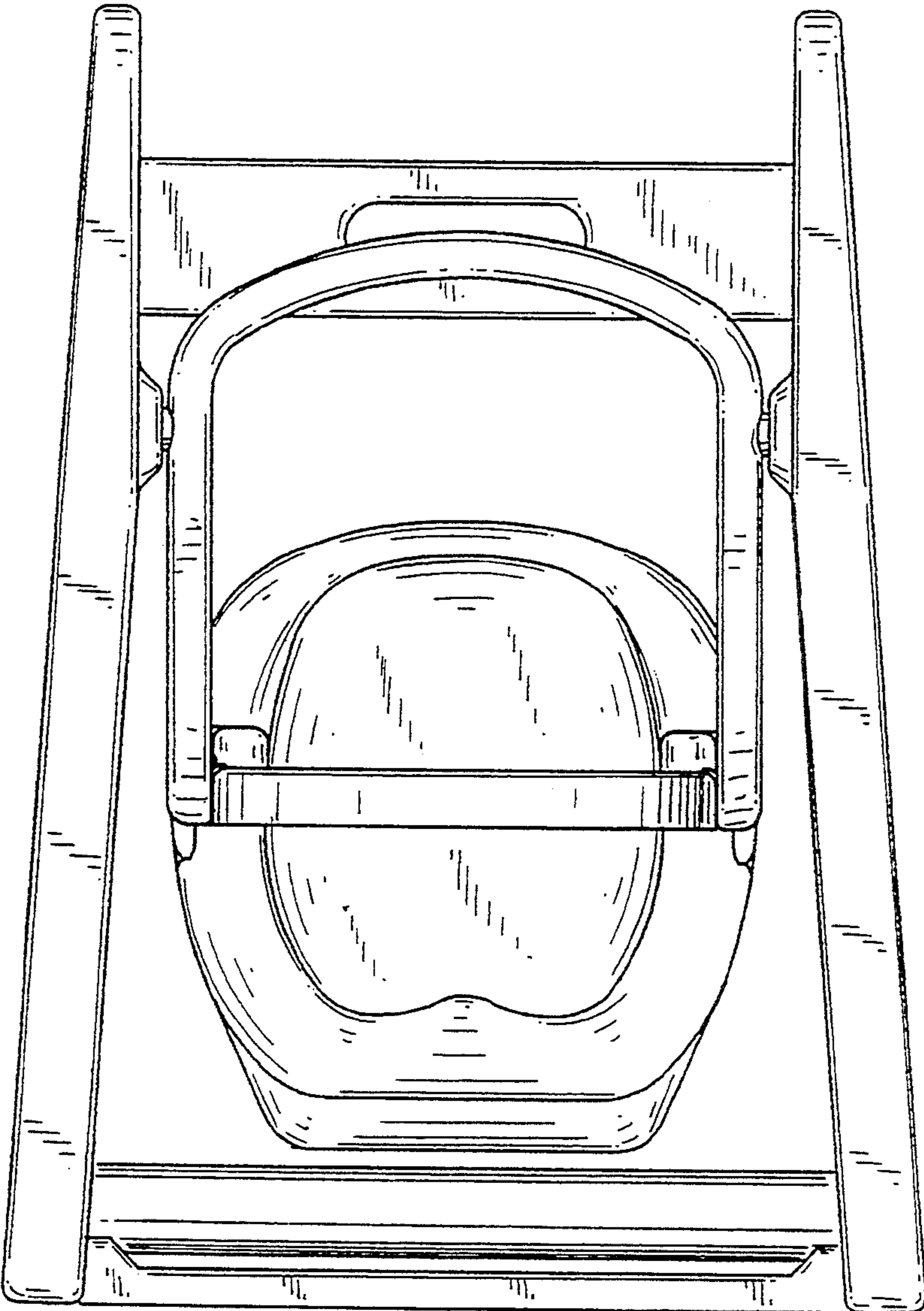

FIG. 7



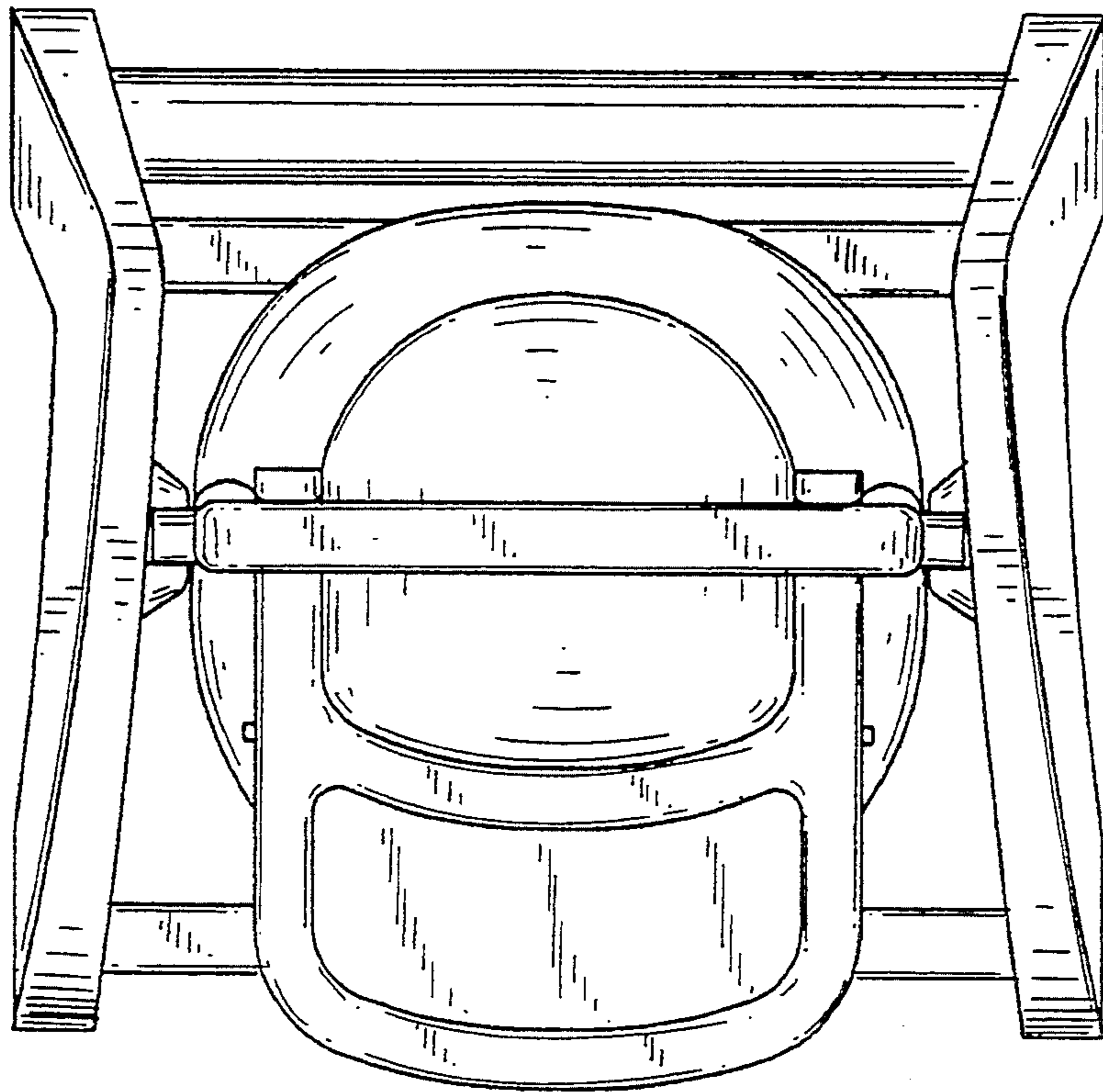

FIG. 8

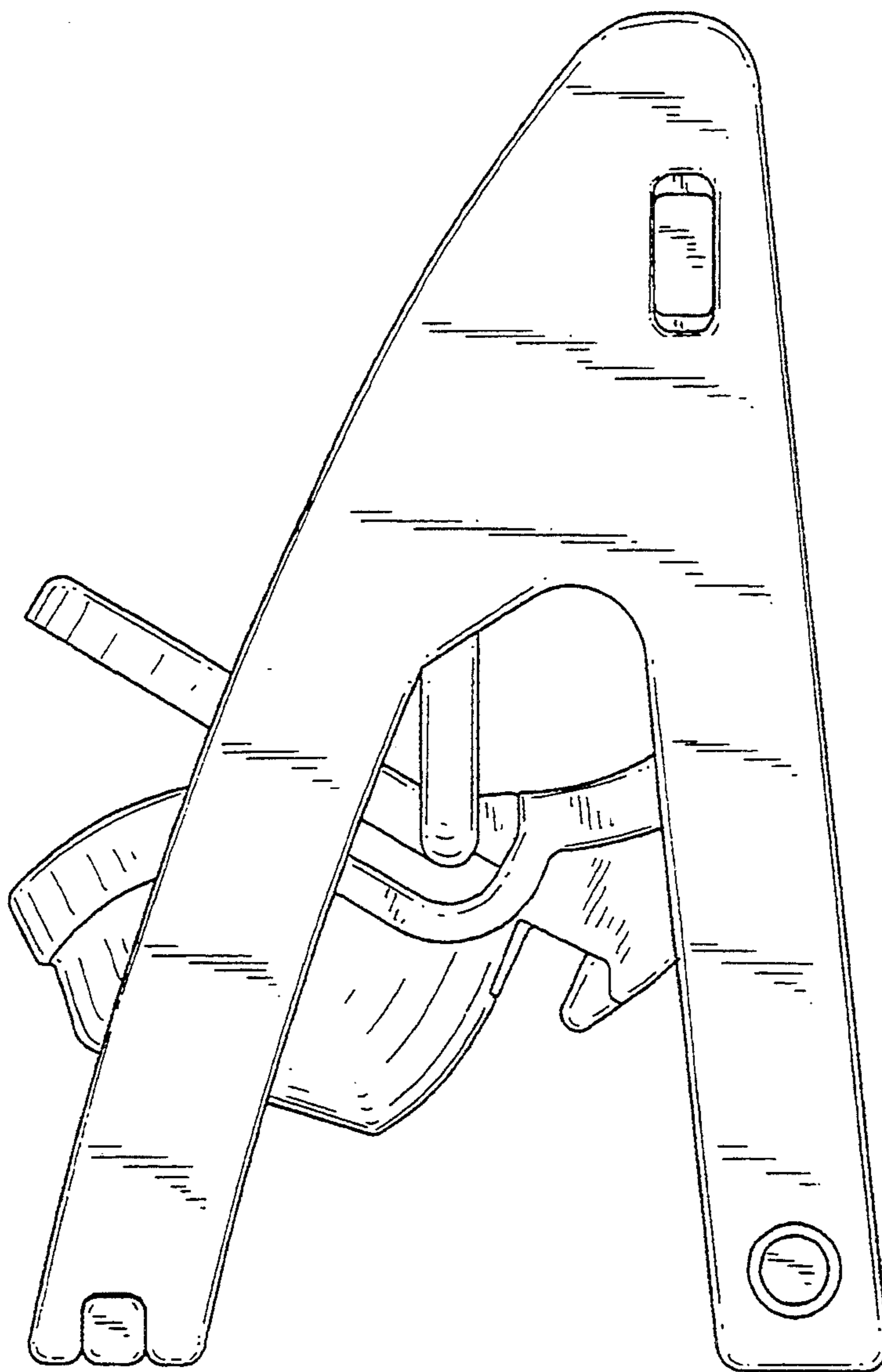

FIG. 9

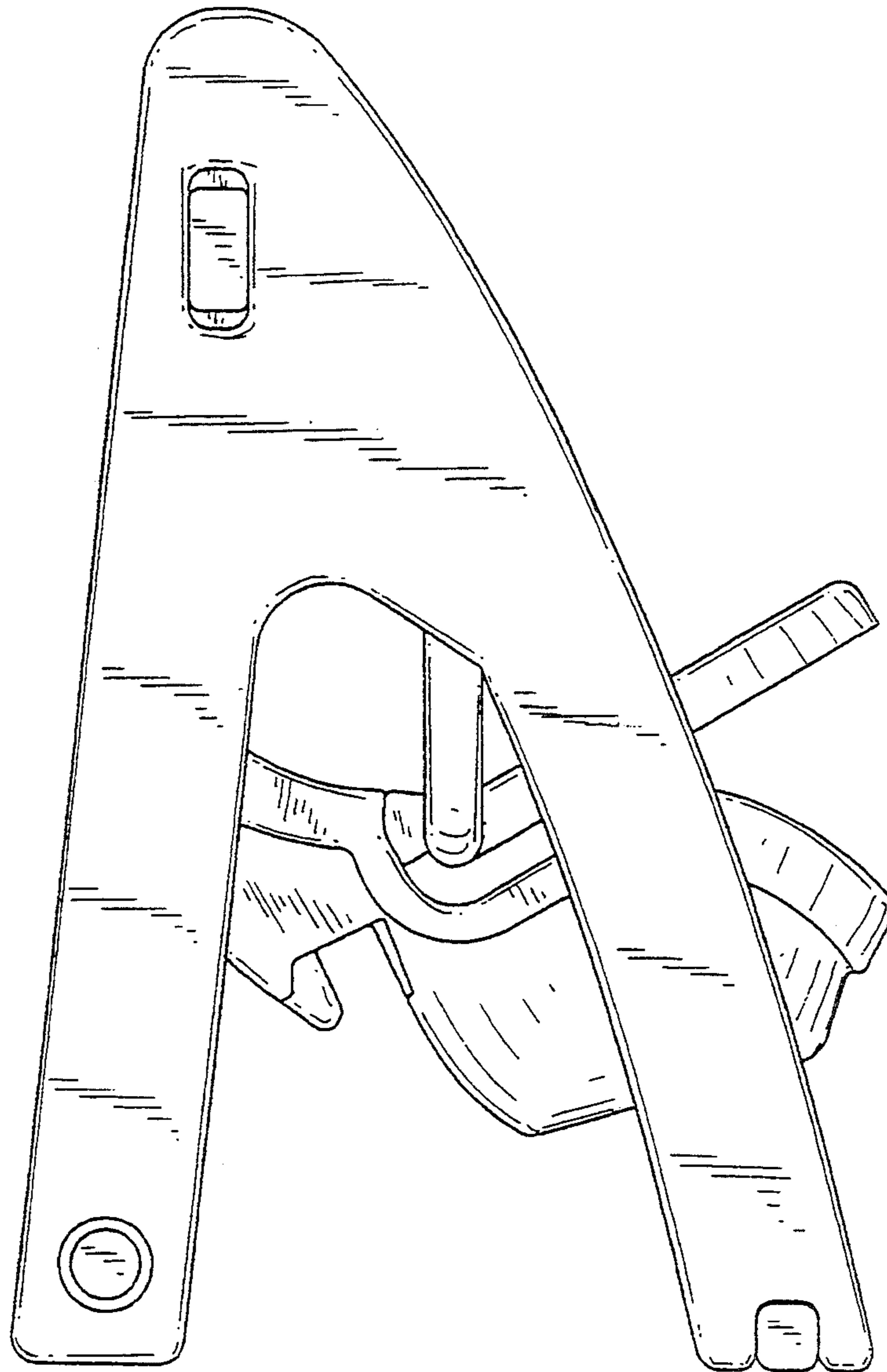

FIG. 10

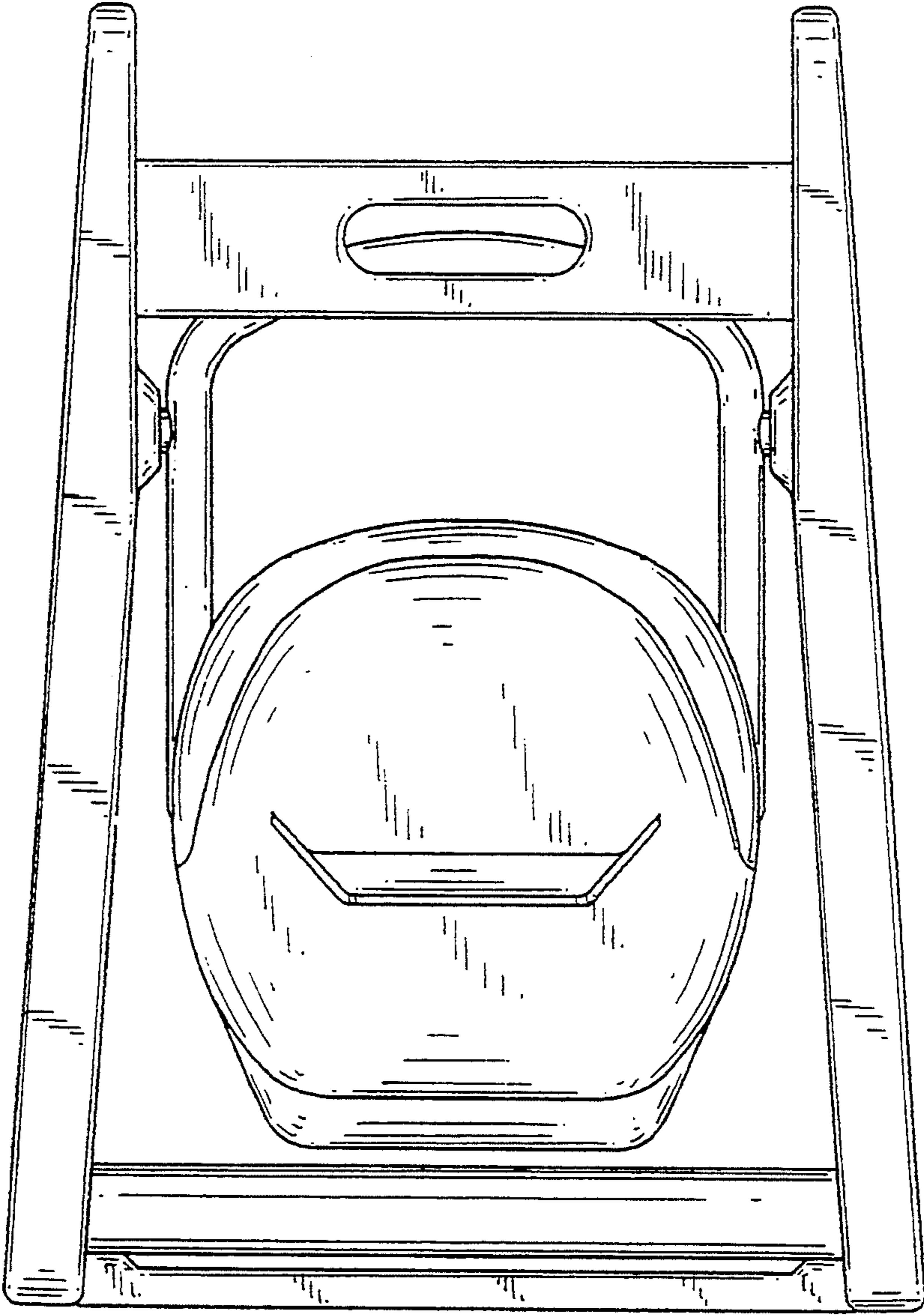

FIG. II

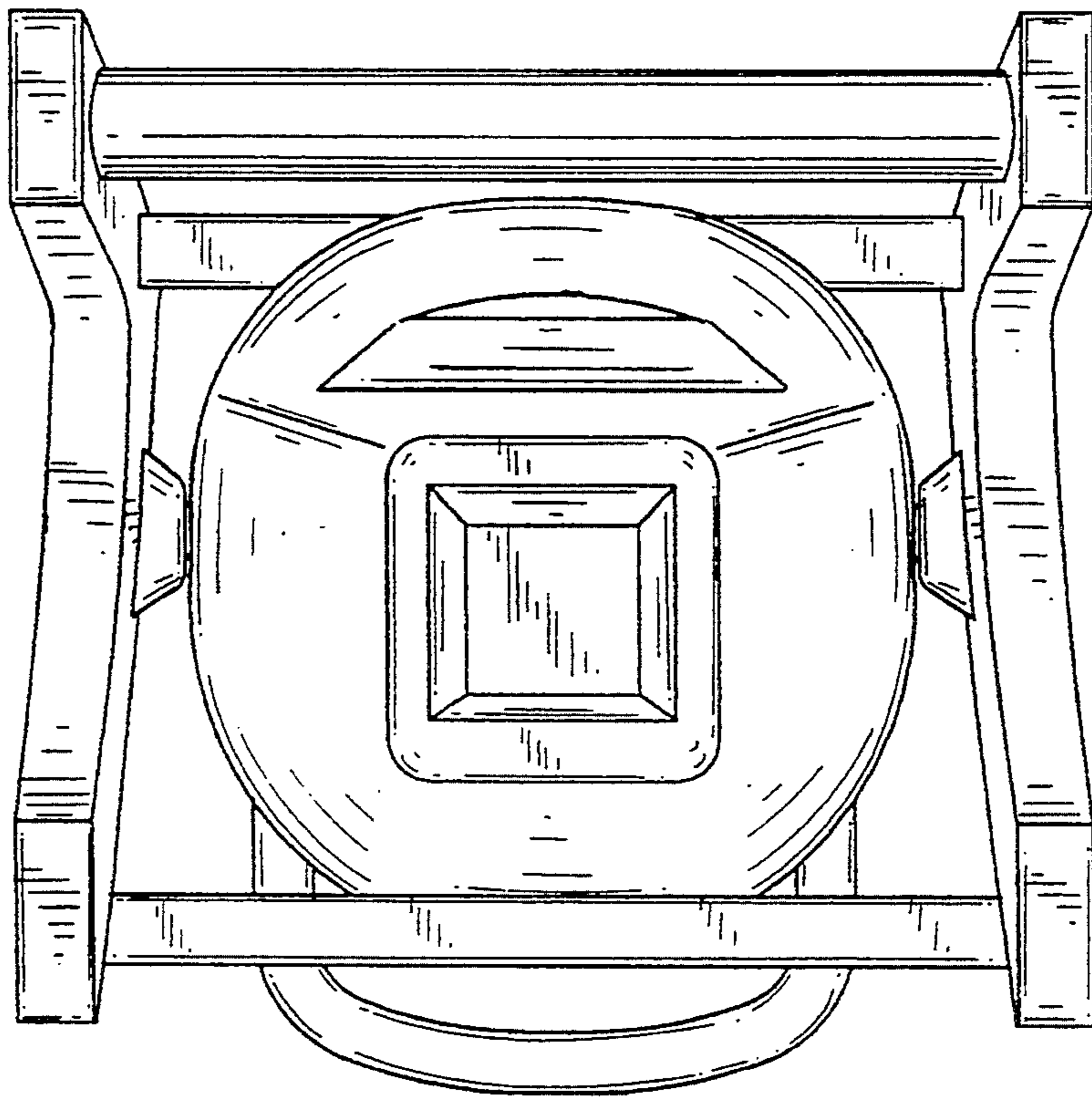

FIG. 12



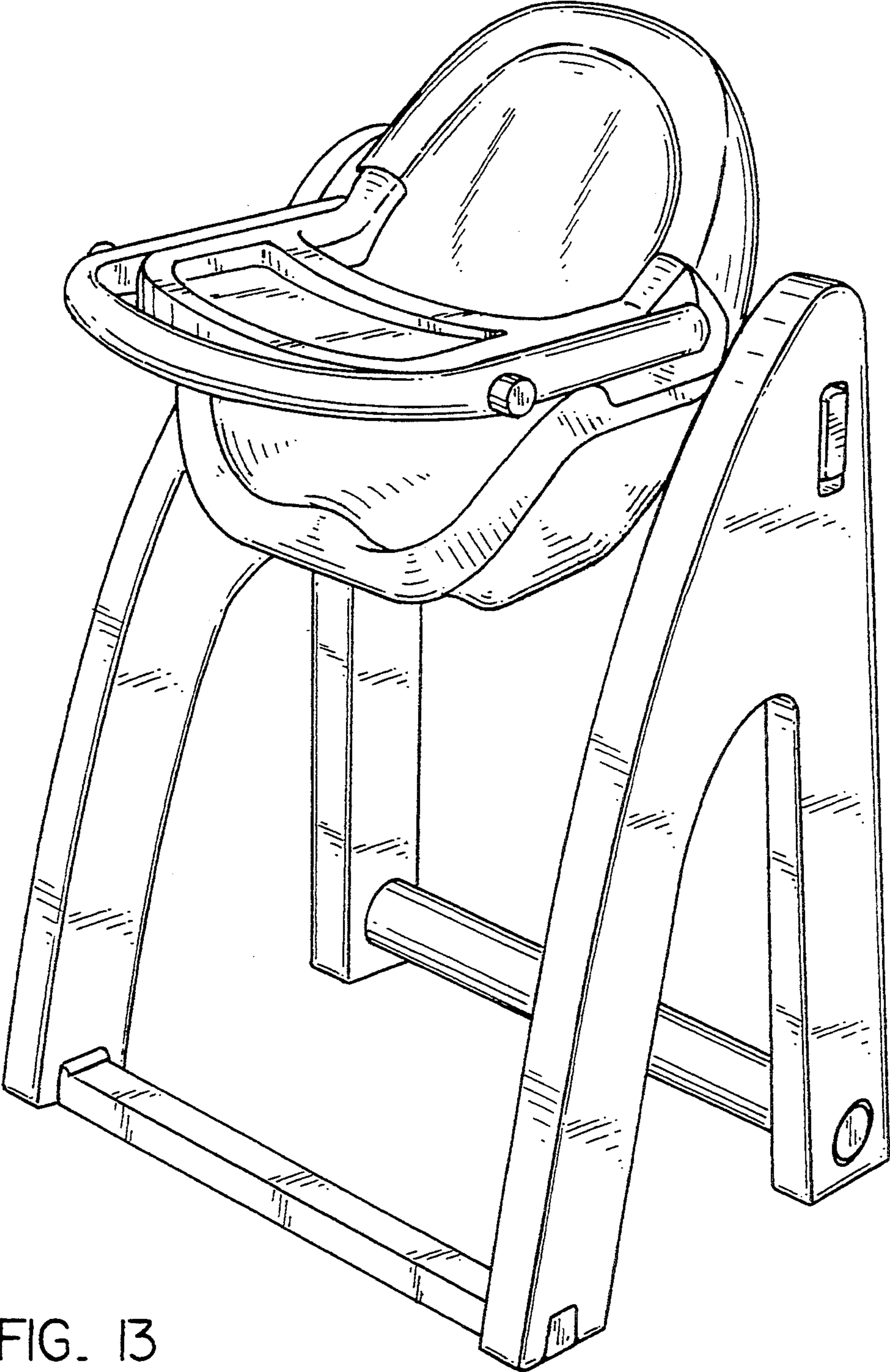

FIG. 13

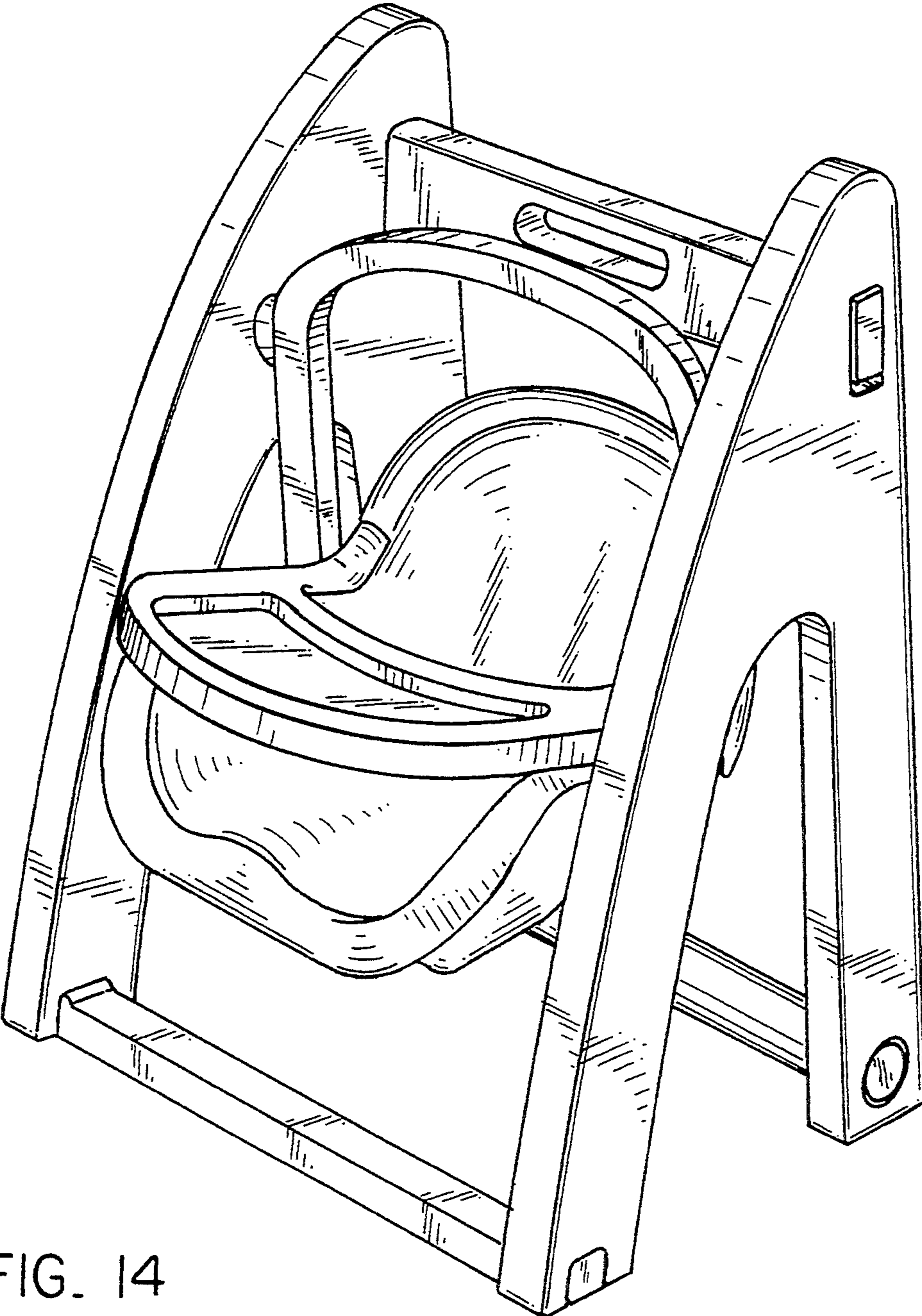

FIG. 14