



US00D358482S

United States Patent [19]

[11] Patent Number: **Des. 358,482**

Taguchi et al.

[45] Date of Patent: **** May 23, 1995**

[54] **COMPARTMENTED SPORT BAG**

[75] Inventors: **Jon Taguchi; Alexander Gajowskyj; Gaile M. Thorstad**, all of Portland, Oreg.

[73] Assignee: **Nike, Inc.**, Beaverton, Oreg.

[**] Term: **14 Years**

[21] Appl. No.: **22,036**

[22] Filed: **Feb. 22, 1994**

3,291,267	12/1966	Pelavin .	
4,090,593	5/1978	Koff .	
4,378,866	4/1983	Pelavin .	
4,781,278	11/1988	Sadow	190/107
4,805,748	2/1989	Gerch	190/103
5,109,961	5/1992	Bergman	190/18 A

FOREIGN PATENT DOCUMENTS

2103086	7/1971	France .
2573635	11/1984	France .
2018580	12/1978	United Kingdom .

OTHER PUBLICATIONS

Nike Spring 1992 Accessories Catalog, pp. 42, 46 & 52 (published Jun. 1991).
 Nike Spring 1989 Accessories Catalog, p. 19 (published Jul. 1988).
 Nike Fall 1989 Accessories Catalog, pp. 4 & 5 (published Feb. 1989).
 Nike Fall 1986 Accessories Catalog, p. 13 (date unknown).

Primary Examiner—Theodore M. Shooman
Assistant Examiner—Mortimer Paula
Attorney, Agent, or Firm—Banner, Birch, McKie & Beckett

Related U.S. Application Data

[63] Continuation of Ser. No. 7,580, Apr. 27, 1993, abandoned.
 [52] U.S. Cl. **D3/273**
 [58] Field of Search D3/283, 221, 285, 286, D3/287, 900, 902, 273; 190/103, 104, 107, 108, 109, 110, 111; 150/163; 206/315.1, 521; 383/2, 37

[56] References Cited

U.S. PATENT DOCUMENTS

Re. 30,138	11/1979	Cowen, III .	
Re. 34,361	8/1993	Pratt	D3/285 X
D. 231,868	6/1974	Ohyama .	
D. 232,270	7/1974	Glantz et al. .	
D. 250,435	11/1978	Cooper .	
D. 254,819	4/1980	Harrison .	
D. 269,226	6/1983	Stark .	
D. 270,112	8/1983	Stark .	
D. 279,142	6/1985	Pulichino et al.	D3/77 X
D. 279,428	7/1985	Thomas	D3/283 X
D. 281,034	10/1985	Weiner .	
D. 282,601	2/1986	Bomes et al. .	
D. 292,747	11/1987	Allen .	
D. 294,085	2/1988	Gibbs	D3/48
D. 307,514	5/1990	Gibbs	D3/48
D. 313,316	1/1991	Nordstrom	D3/48 X
D. 315,985	4/1991	Gerch et al.	D3/76
D. 317,081	5/1991	King	D3/77 X
D. 344,184	2/1994	Barker	D3/283
1,711,349	4/1929	Howard .	
3,061,057	10/1962	Miller .	
3,122,225	2/1964	Ward .	

[57] CLAIM

The ornamental design for a compartmented sport bag, as shown and described.

DESCRIPTION

FIG. 1 is a left side elevational view of a compartmented sport bag showing my new design;
 FIG. 2 is a right side elevational view of the compartmented sport bag shown in FIG. 1;
 FIG. 3 is an elevational view taken at one end of the compartmented sport bag shown in FIG. 1;
 FIG. 4 is an elevational view taken at the other end of the compartmented sport bag shown in FIG. 1;
 FIG. 5 is a top plan view of the compartmented sport bag shown in FIG. 1;
 FIG. 6 is a bottom plan view of the compartmented sport bag shown in FIG. 1; and,
 FIG. 7 is a perspective view of the compartmented sport bag of FIG. 1.

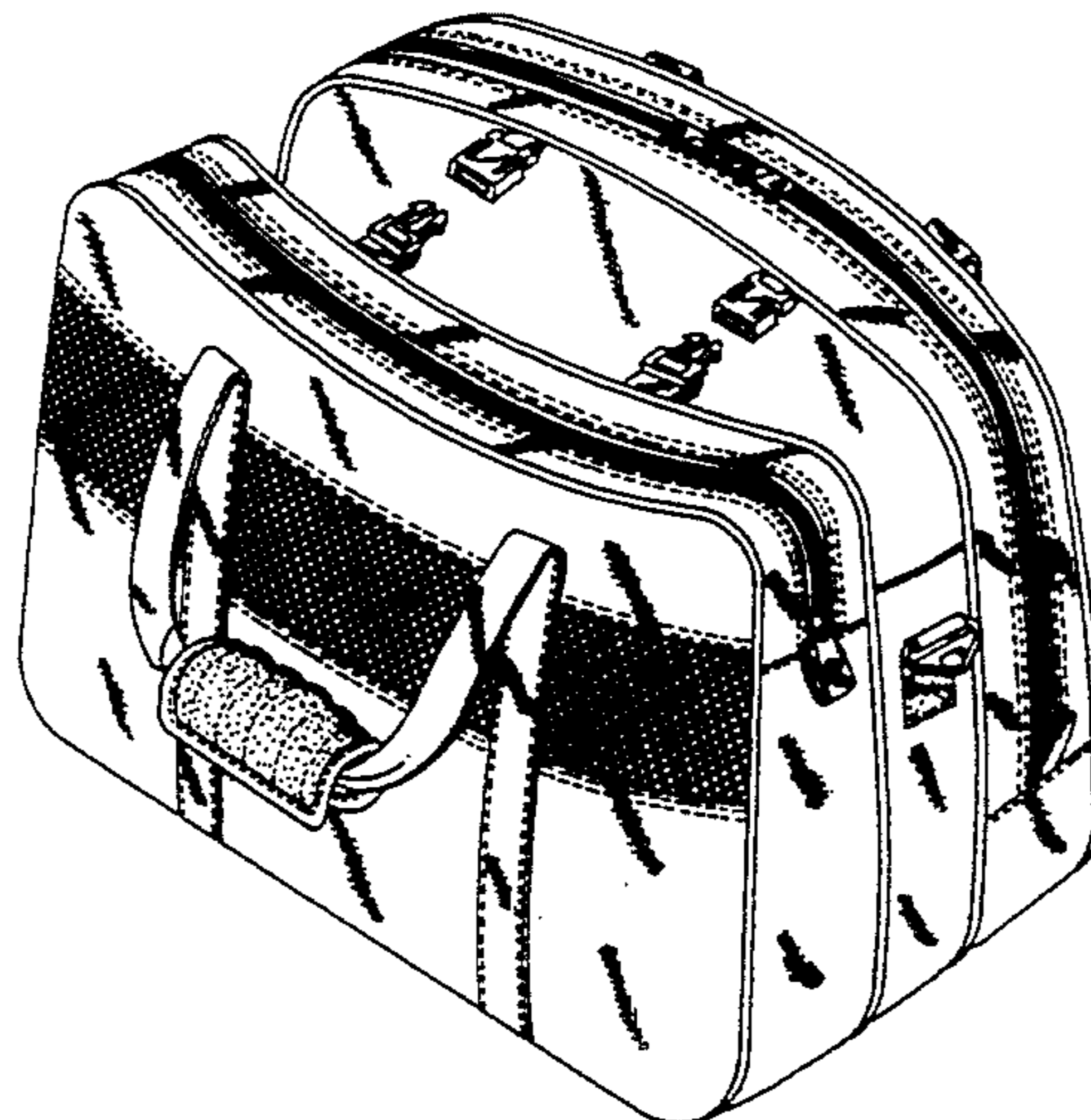

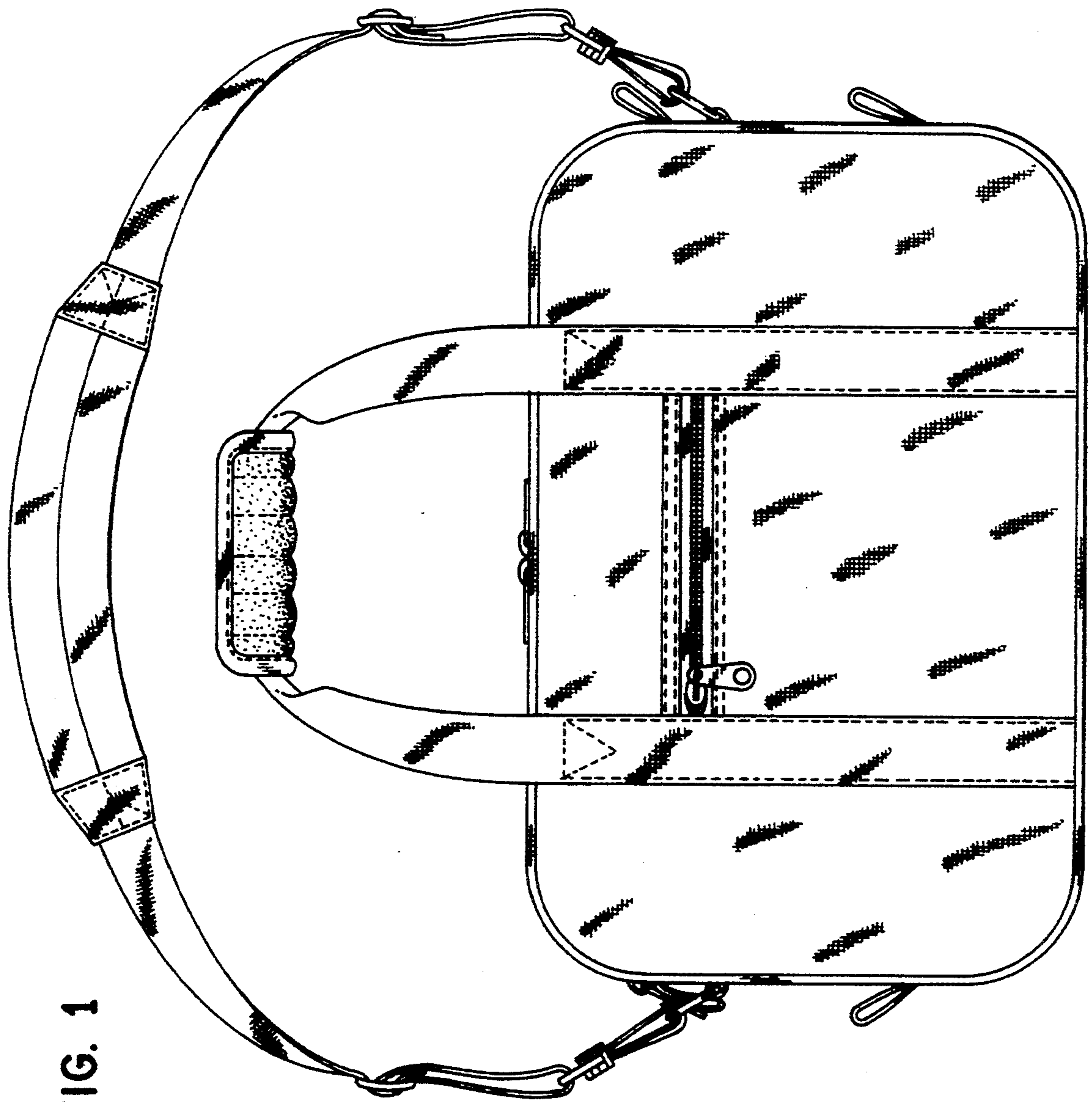

FIG. 1

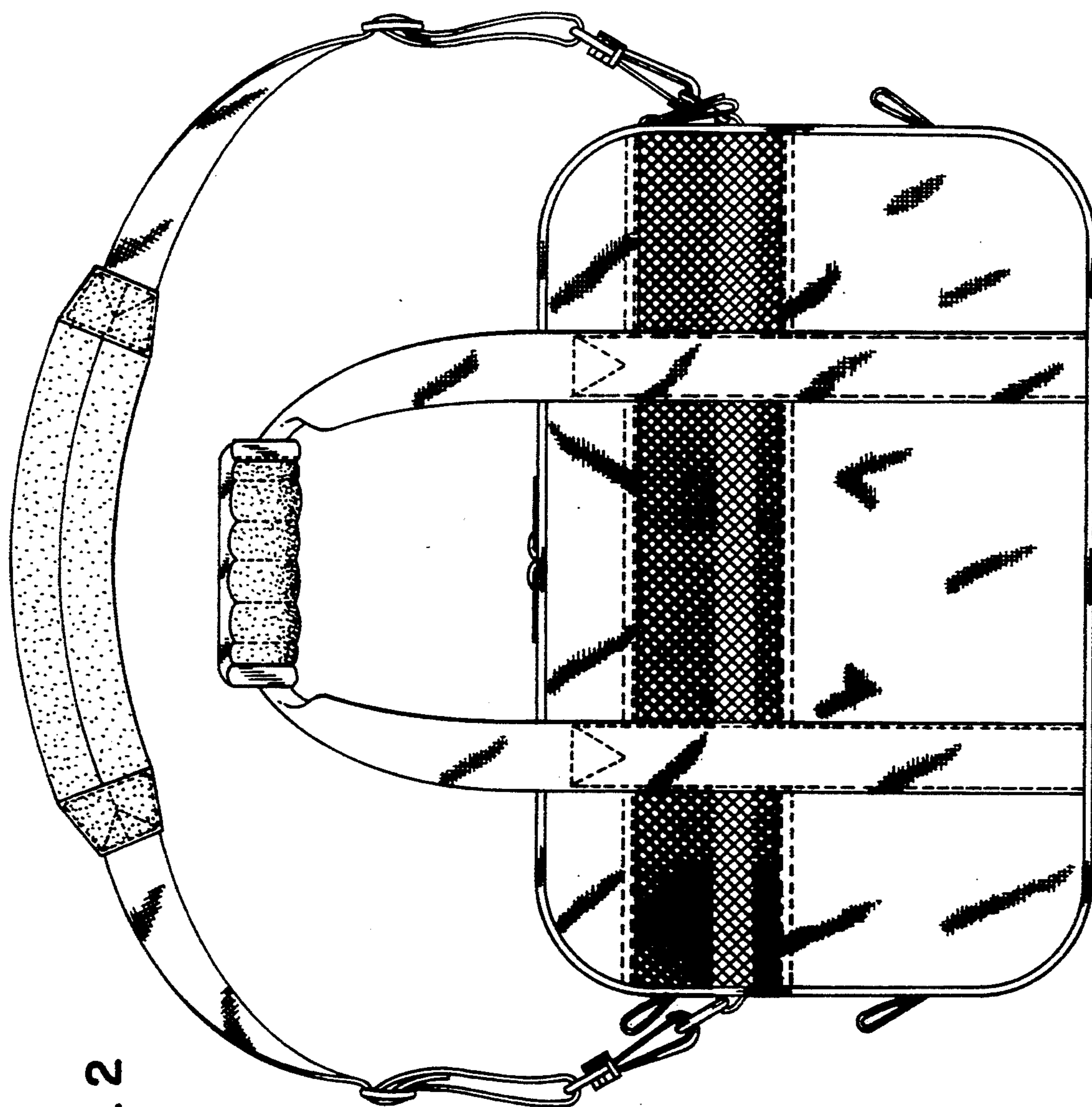

FIG. 2

FIG. 4

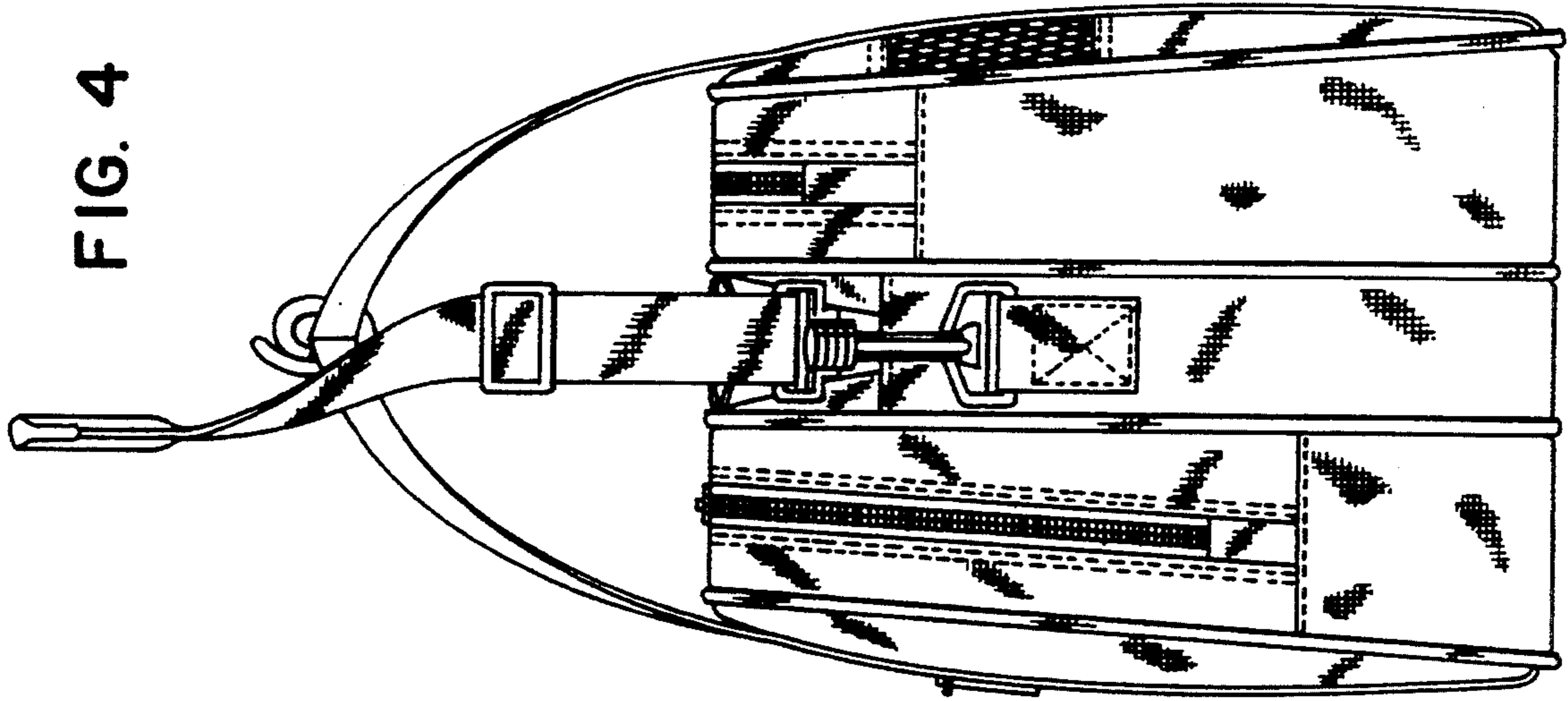

FIG. 3

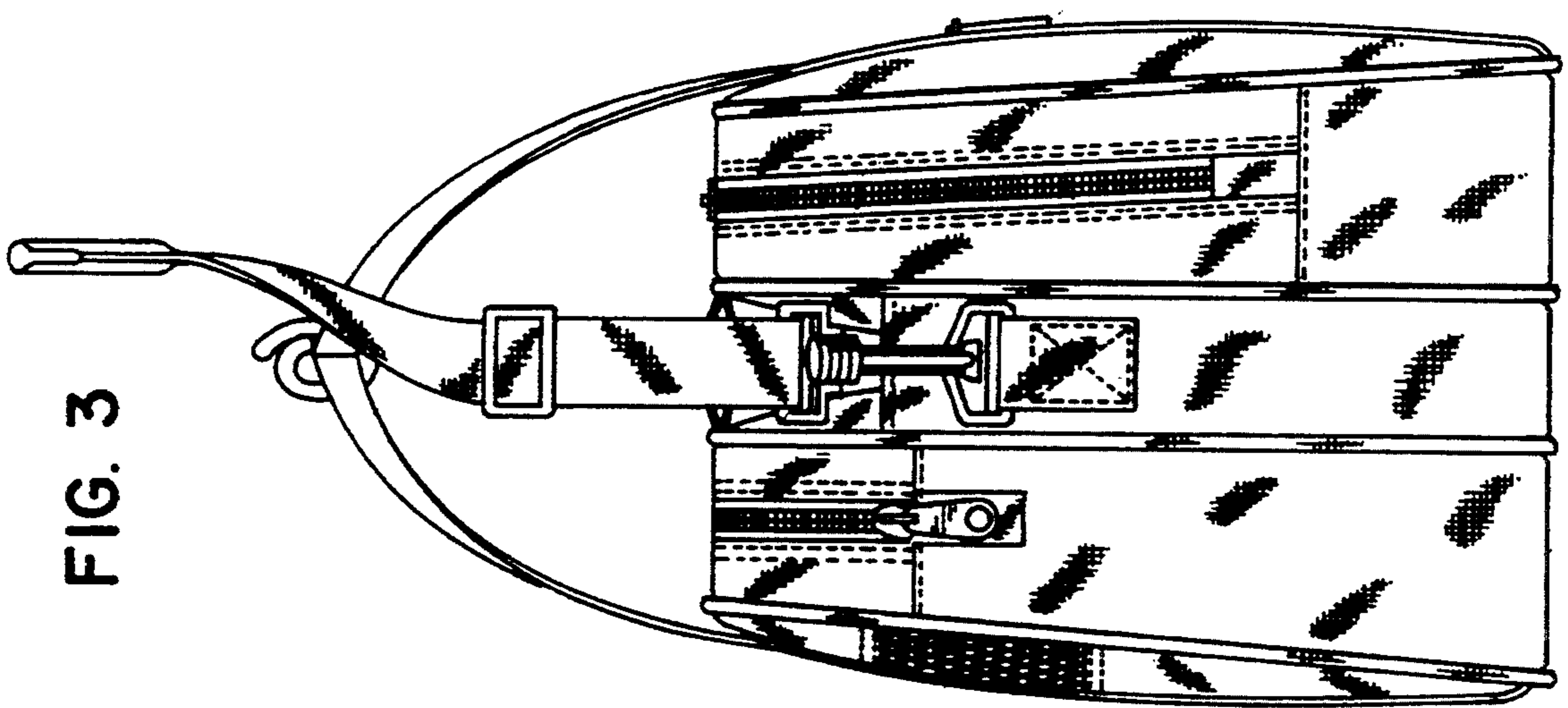

FIG. 5

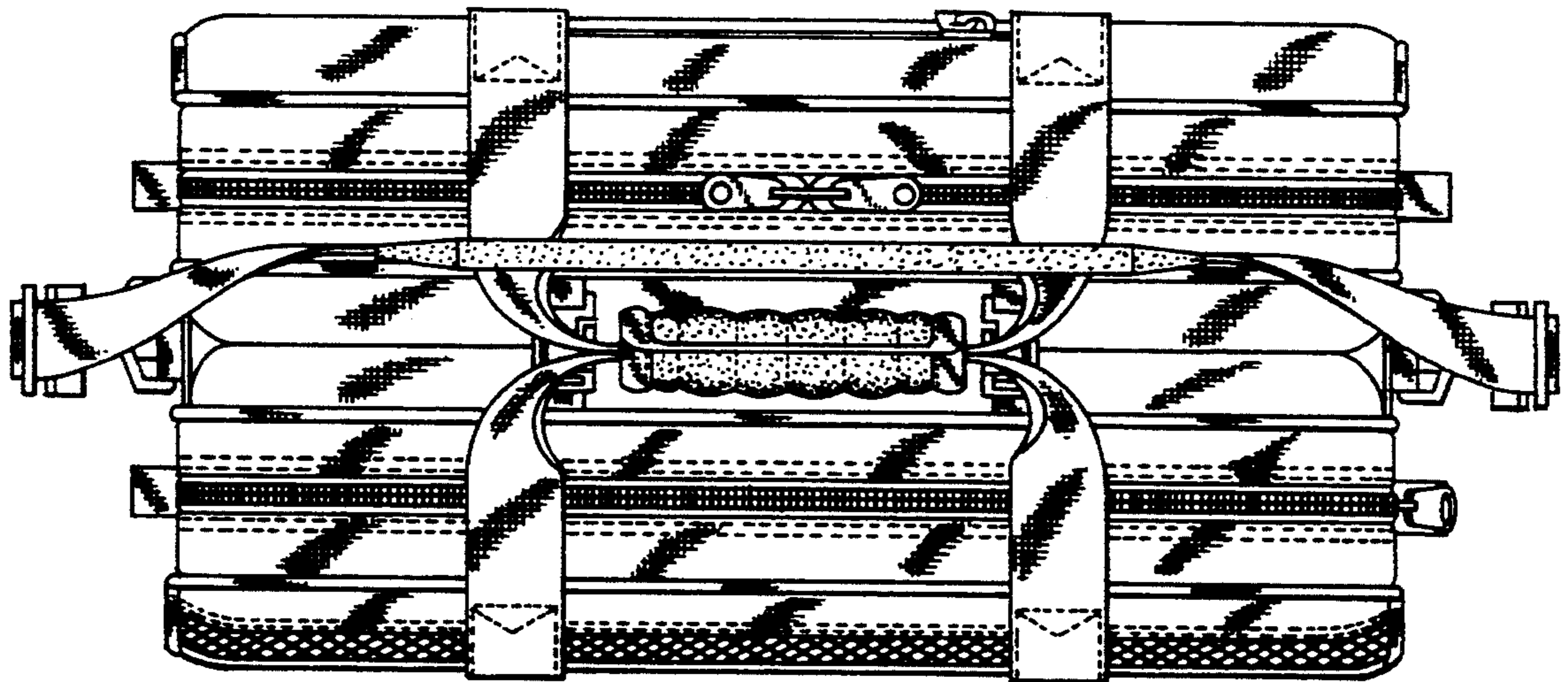

FIG. 6



FIG. 7

