



US00D358434S

United States Patent [19]

[11] Patent Number: **Des. 358,434**

Brown et al.

[45] Date of Patent: **** May 16, 1995**

[54] **CHILD'S DESK**

[75] Inventors: **Patrick Brown**, Strongsville; **Joseph C. Cacciola**, Hudson; **John R. Nottingham**, Chagrin Falls; **John W. Spirk**, Moreland Hills, all of Ohio

[73] Assignee: **The Little Tikes Company**, Hudson, Ohio

[**] Term: **14 Years**

[21] Appl. No.: **15,413**

[22] Filed: **Nov. 17, 1993**

[52] U.S. Cl. **D21/121; D6/421; D6/426**

[58] Field of Search **D6/421-428; D21/121; 312/194-196, 204**

[56] **References Cited**

U.S. PATENT DOCUMENTS

D. 215,098	9/1969	Wilcox	D6/421
D. 250,380	11/1978	Verdesca et al. .	
D. 269,196	5/1983	Appel et al.	D21/121
D. 282,218	1/1986	Catelli	D21/121
D. 295,474	5/1988	Uredat-Neuhoff	D6/484
D. 296,800	7/1988	Benedetto et al.	D21/121
D. 306,105	2/1990	Newhouse	D6/420
D. 311,753	10/1990	Westland et al.	D18/23
D. 318,768	8/1991	Westland et al.	D6/422
D. 330,573	10/1992	Monneret	D21/121

OTHER PUBLICATIONS

P. 163, Workstation; Global Computer Supplies, 2318 E. Del Amo Blvd., Dept. 31, Compton, Calif. 90220. Publication date Jan., 1992.

Catalog page, Desk; Step 2 Corporation, Twinsburg, Ohio. Publication date 1993.

P. 120, Table; The Little Tikes Company, 2180 Barlow Rd., Hudson, Ohio 44236. Publication date 1992.

Catalog page, Desk; Rubbermaid Incorporated, 1147 Akron Rd., Wooster, Ohio 44691. Publication date 1993.

Primary Examiner—Carmen H. Vales-Lado

Attorney, Agent, or Firm—Richard B. O'Planick; Lisa B. Riedesel

[57] **CLAIM**

The ornamental design for a child's desk, as shown and described.

DESCRIPTION

FIG. 1 is a top left front perspective view of a child's desk showing our new design;

FIG. 2 is a front perspective view thereof;

FIG. 3 is a bottom perspective view thereof;

FIG. 4 is a right side perspective view, the left side view being a mirror image thereof;

FIG. 5 is a rear perspective view thereof; and,

FIG. 6 is a top perspective view thereof.

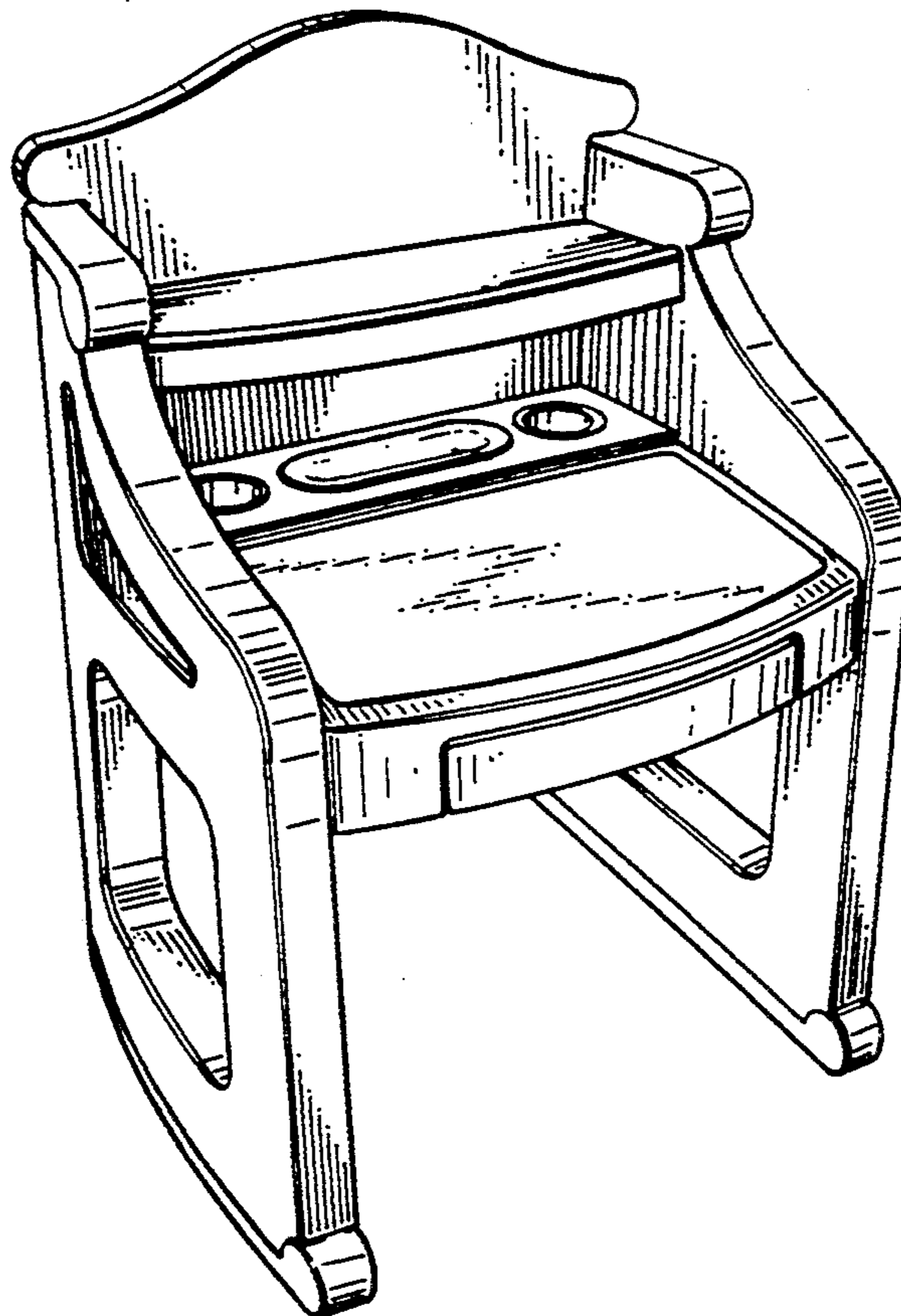

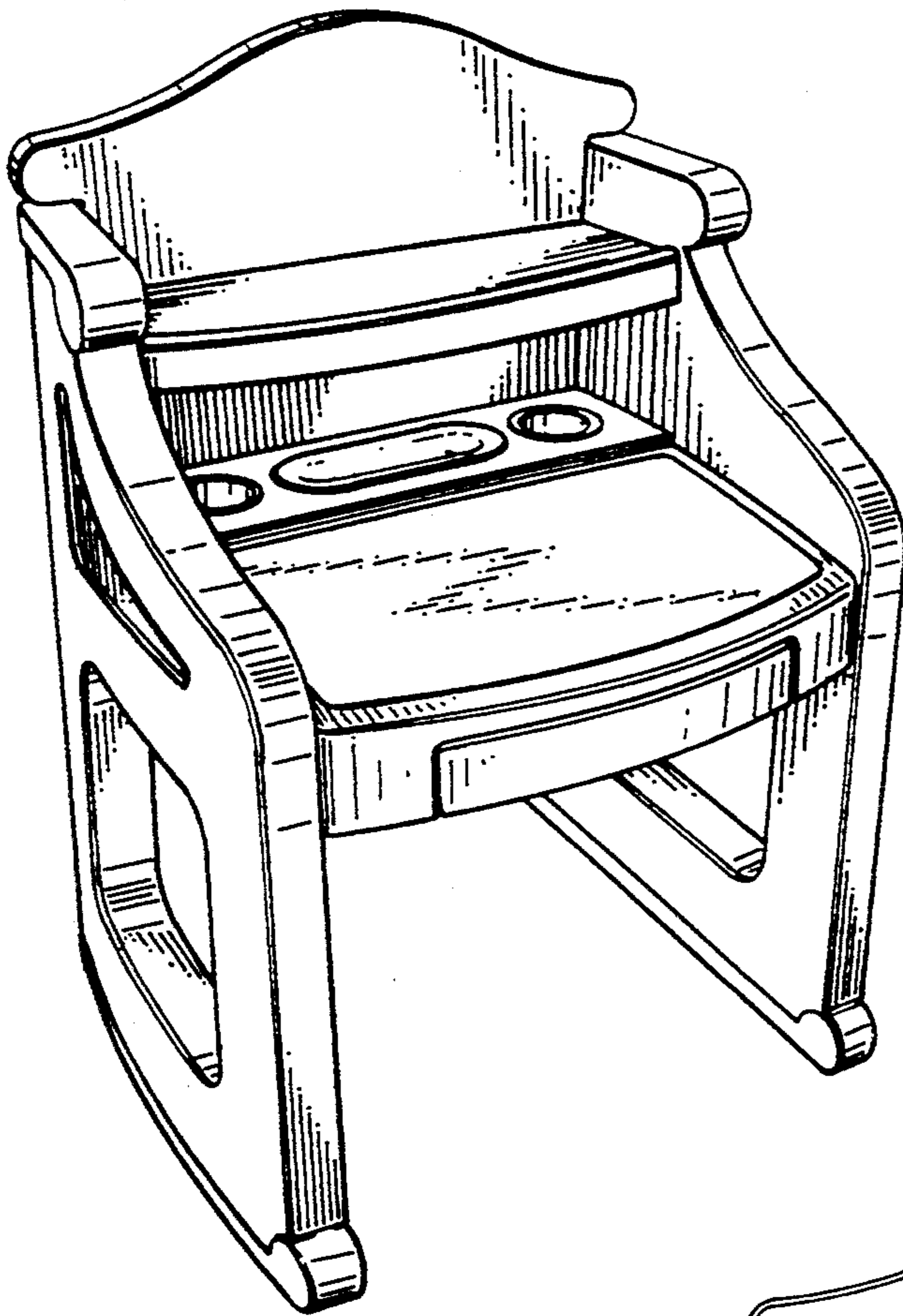

FIG. 1

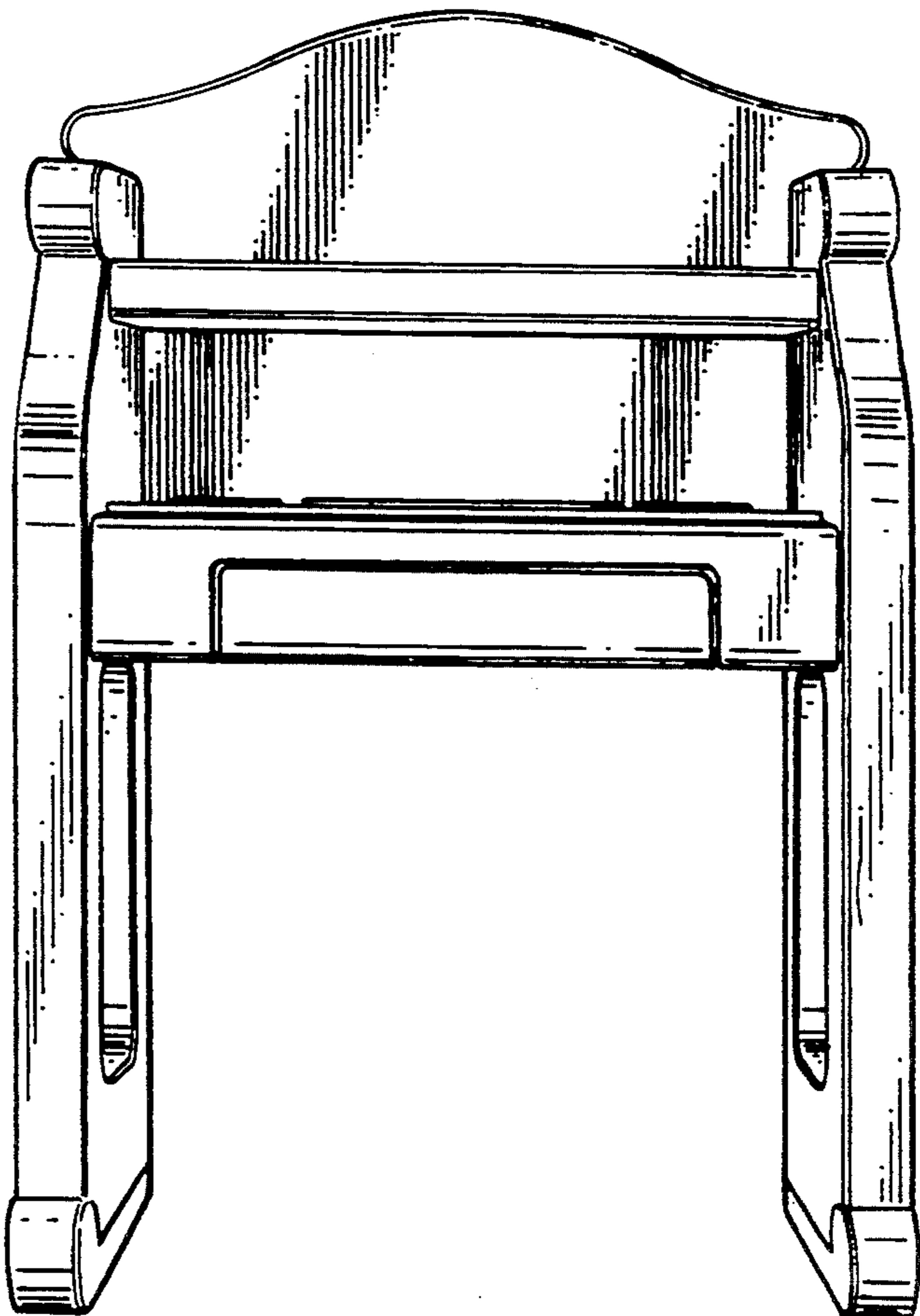

FIG. 2

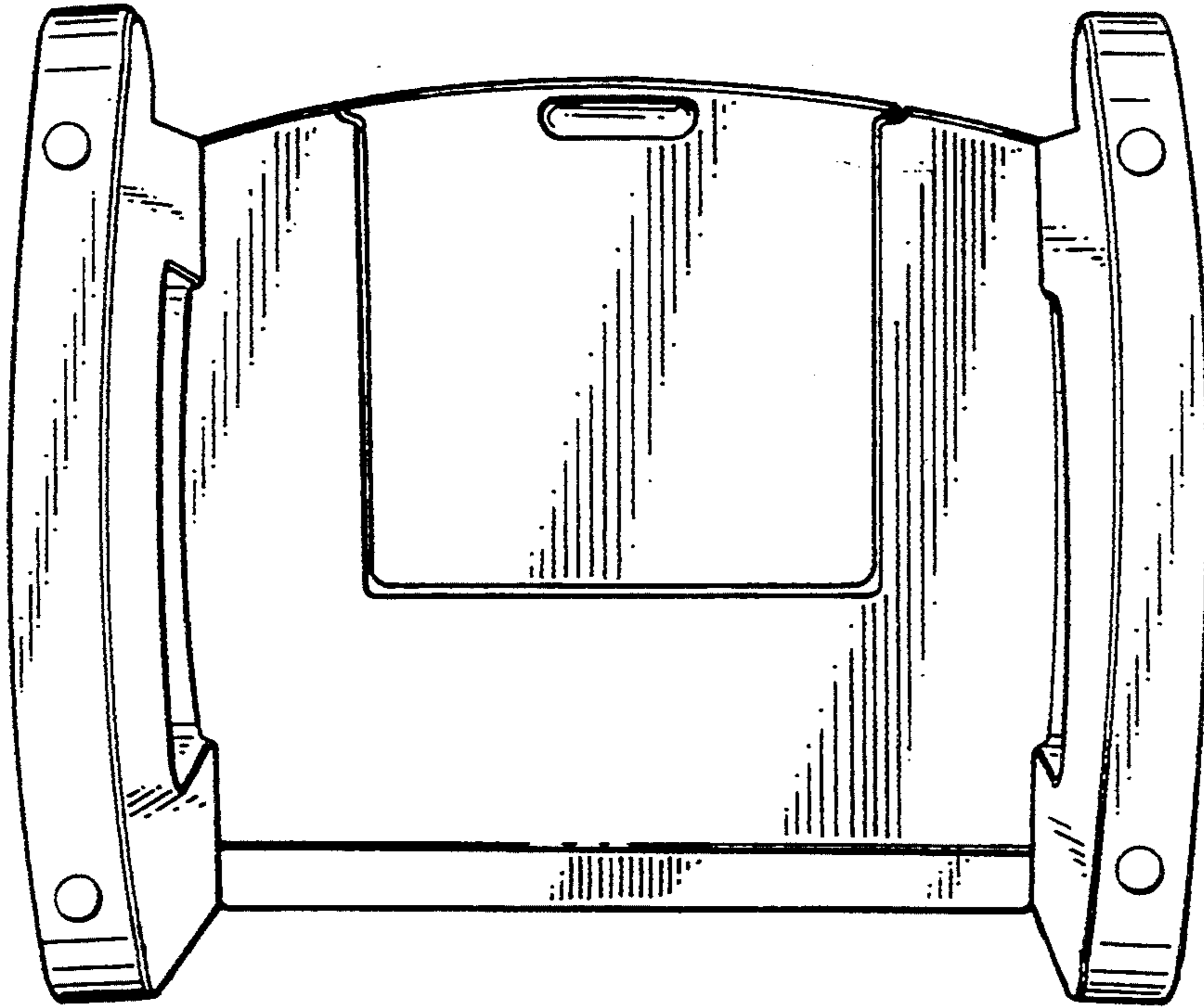

FIG. 3

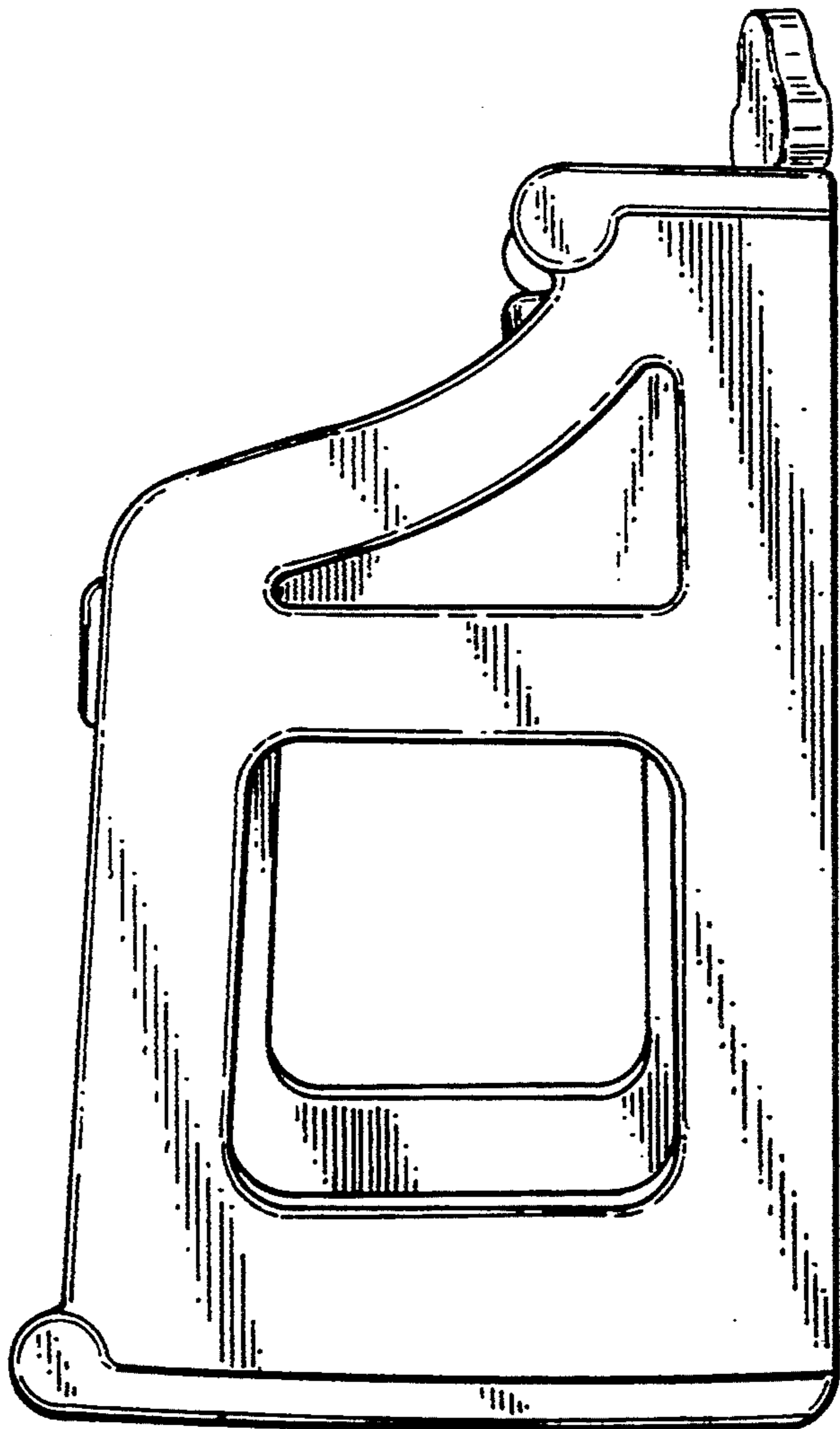

FIG. 4

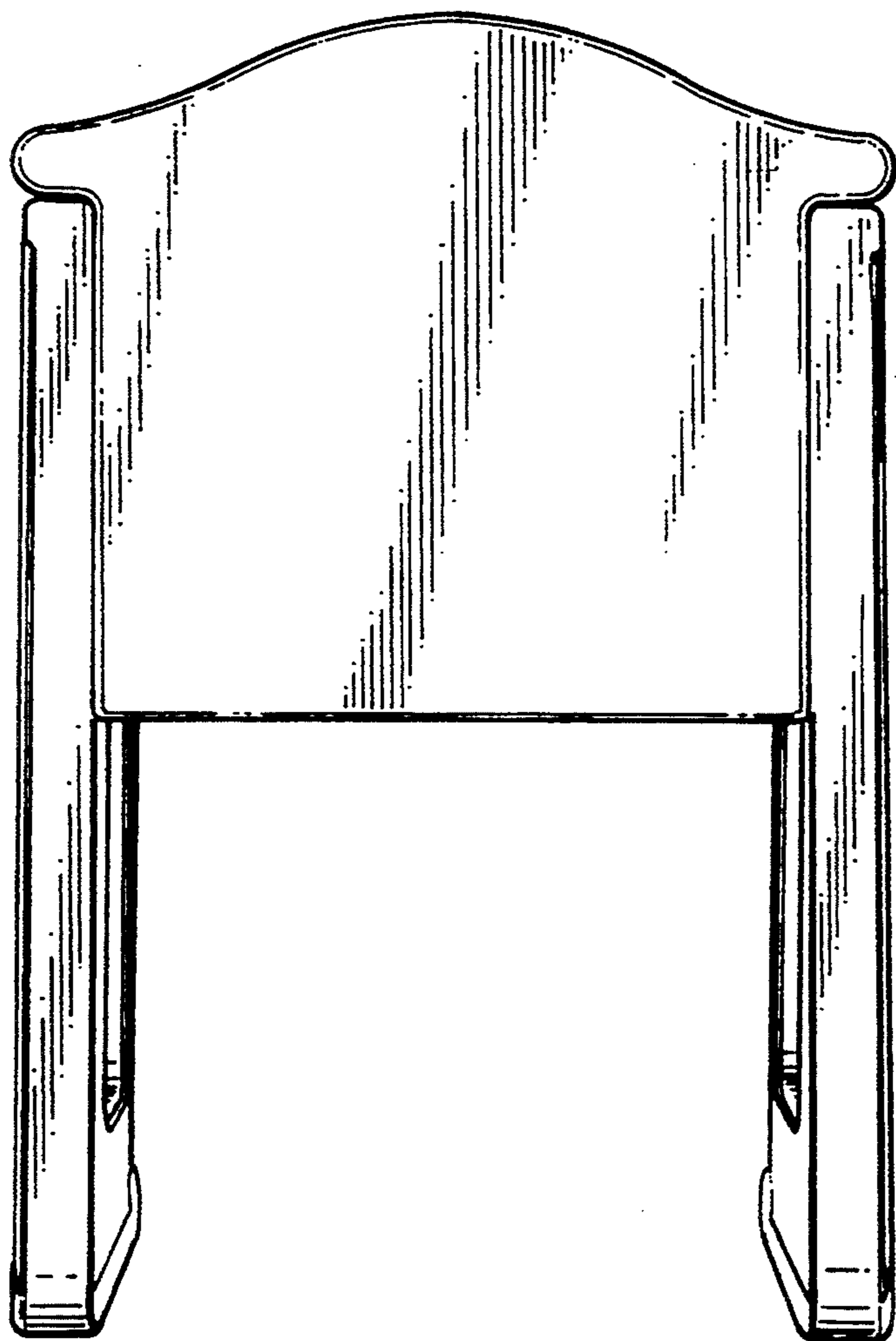

FIG. 5

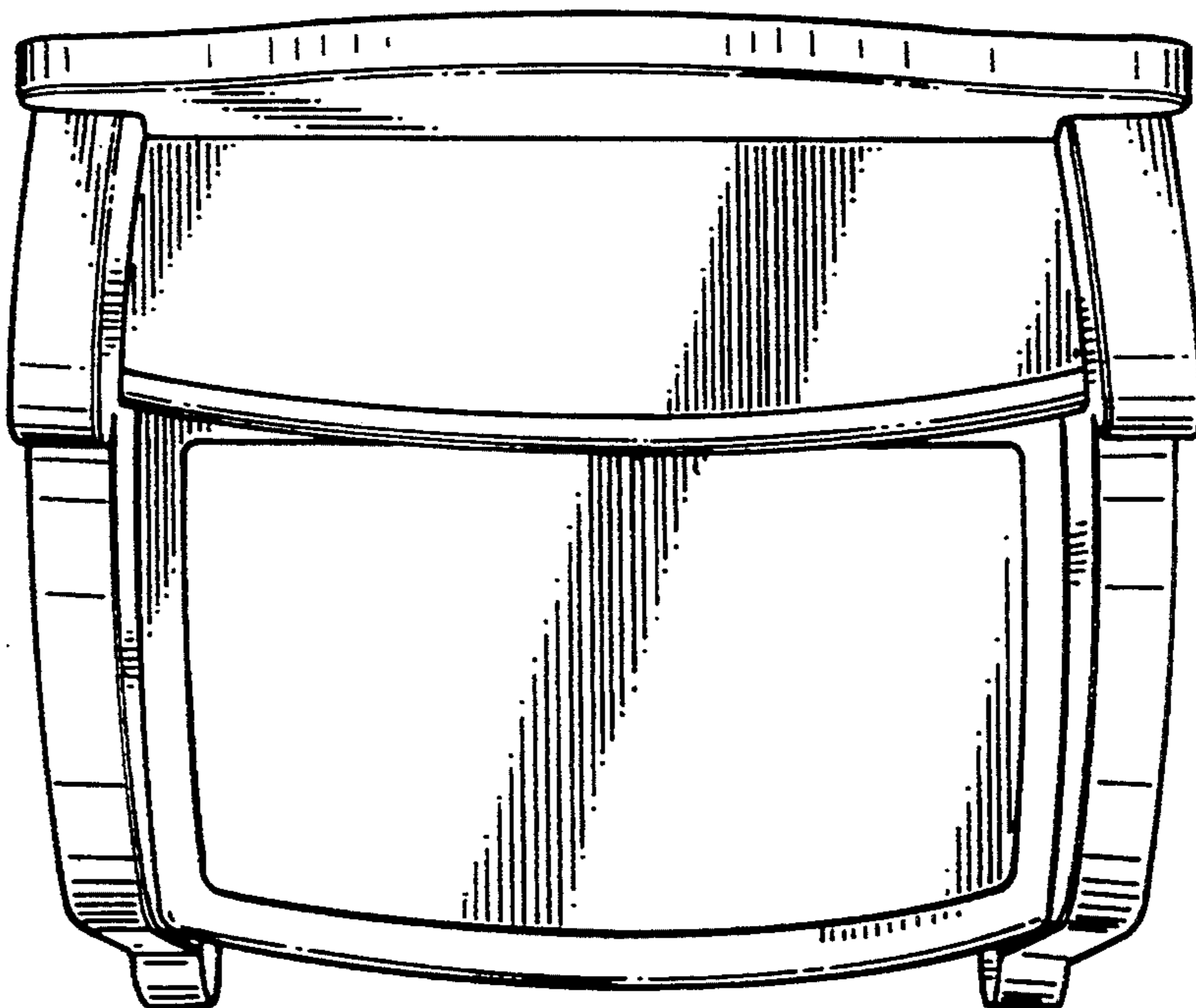

FIG. 6